

REVUE TECHNIQUE

MASAI S750I





Standard Motor Corporation

JMAX 700 ATV Service Manual



JMAX702



JMAX701



JMAL701



JMBX701

This service manual contains the technical data of each component inspection and repair for the SMC JM series 700 ATVs as above. The manual is shown with illustrations and focused on "Service Procedures", "Operation Key Points", and "Inspection Adjustment" so that provides technician with service guidelines.

In this second version, SMC added related EFI system in overall and detailed in Chapter 19.

If the style and construction of the ATV, SMC JM series 700 ATV, are different from that of the photos, pictures shown in this manual, the actual vehicle shall prevail. Designs and specifications are subject to change without notice.

Service Department
Standard Motor Corporation

HOW TO USE THIS MANUAL

This service manual describes basic information of different system parts and system inspection & service for SMC JM series 700 ATV. In addition, please refer to the manual contents in detailed for the model you serviced in inspection and adjustment.

Chapter.1 includes general information and trouble diagnosis.

Chapter 2 includes service maintenance information.

Chapter3~12 includes engine and transmission systems.

Chapter 13 includes cooling system.

Chapter 14~18 includes assembly frame body.

Chapter 19 includes electronic fuel injection system

Chapter 20 includes electrical equipment.

Chapter 21 includes wiring diagram.

Please see index of content for quick having the special parts and system information.

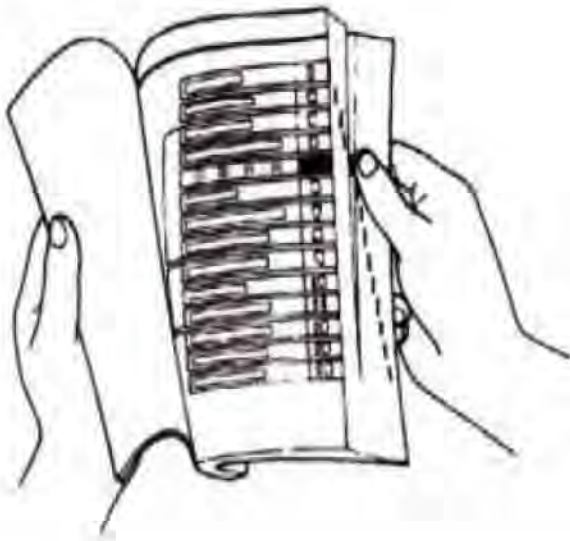



SERIAL NUMBER

Frame number:



Engine number:





<u>CONTENTS</u>	<u>Page Content</u>	<u>Index</u>
1-1 ~ 1-22	GENERAL INFORMATION	1
2-1 ~ 2-23	MAINTENANCE INFORMATION	2
3-1 ~ 3-10	LUBRICANT SYSTEM	3
4-1 ~ 4-20	FUEL SYSTEM	4
5-1 ~ 5-11	BODY COVER & ENGINE REMOVAL	5
6-1 ~ 6-19	CYLINDER HEAD/VALVES	6
7-1 ~ 7-10	CYLINDER/PISTON/RING	7
8-1 ~ 8-12	CVT DRIVING SYSTEM	8
9-1 ~ 9-8	GENERATOR/STARTING CLUTCH/WATER PUMP	9
10-1 ~ 10-5	GEAR SHIFTING BOX	10
11-1 ~ 11-15	TRANSMISSION	11
12-1 ~ 12-6	CRANKSHAFT/BALANCER	12
13-1 ~ 13-18	LIQUID COOLING SYSTEM	13
14-1 ~ 14-14	FRONT WHEEL/BRAKE	14
15-1 ~ 15-14	FRONT STEERING/SUSPENSION	15
16-1 ~ 16-22	REAR WHEEL/BRAKE/SUSPENSION	16
17-1 ~ 17-18	WHEEL DRIVE AXLE/DRIVE SHAFT	17
18-1 ~ 18-8	REAR/FRONT GEAR BOX	18
19-1 ~ 19-35	ELECTRNOIC FUEL INJECTION	19



20-1 ~ 20-31	ELECTRICAL EQUIPMENT	20
21-1 ~ 21-6	WIRING DIAGRAM	21

1-01. Symbols and Marks
1-02. General Safety
1-03. Service Precautions
1-04. Specifications
1-05. Torque Values
1-06. Troubles Diagnosis

1. General Information

This chapter offer you the general information of SMC ATV 700 safety notice, caution and the tools torque setting, please read carefully and make sure you have well acknowledge and skills before start to do any repair/inspection jobs as mentioned at furthering chapters.

1-01. Symbols and Marks

Symbols and marks are used in this manual to indicate what and where the special service is needed. In case supplemental information of procedures is needed for these symbols and marks, explanations will be added to the text instead of using the symbols or marks.

Warning	Means that serious injury or even death may result if procedures are not followed.
Caution	Means that equipment damages may result if procedures are not followed.
Engine oil	Limits to use SAE 10W-40 API/SH class or above oil. Warranty will not cover the damage that caused by not apply with the limited engine oil.
Grease	Chassis grease is recommended.
Gear oil	Gear oil serials are recommended. (Gear oil SAE 80/90 is recommended)
Locking sealant	Apply sealant; medium strength sealant should be used unless otherwise specified.
Oil seal	Apply with lubricant.
Renew	Replace with a new part before installation.
Brake fluid	Use recommended brake fluid DOT4.
Special tools	Special tools
Correct	Meaning correct installation.
Wrong	Meaning wrong installation.
Indication	Indication of components.
Directions	Indicates position and operation directions

1-02 General information refer to your own safety

Below are some of the general information to your own safety during the repair/service time.

Carbon monoxide

If you must run your engine, ensure the place is well ventilated. Never run your engine in a closed area. Run your engine in an open area, if you have to run your engine in a closed area, be sure to use an extractor.

Caution

Exhaust contains toxic gas which may cause one to lose consciousness and even result in death.

Gasoline

Gasoline is a low ignition point and explosive material. Work in a well-ventilated place, no flame or spark should be allowed in the work place or where gasoline is being stored.

Caution

Gasoline is highly flammable, and may explode under some conditions, keep it away from children.

Used engine oil

Caution

Prolonged contact with used engine oil (or transmission oil) may cause skin cancer although it might not be verified. We recommend that you wash your hands with soap and water right after contacting. Keep the used oil beyond reach of children.

Hot components

Caution

Components of the engine and exhaust system can become extremely hot after engine running. They remain very hot even after the engine has been stopped for some time. When performing service work on these parts, wear insulated gloves and wait until cooling off.

Battery

Caution

- Battery emits explosive gases; Flame is strictly prohibited. Keep the place well ventilated when charging the battery.
- Battery contains sulfuric acid (electrolyte) which can cause serious burns so be careful do not be spray on your eyes or skin. If you get battery acid on your skin, flush it off immediately with water. If you get battery acid in your eyes, flush it off immediately with water and then go to hospital to see an ophthalmologist.
- If you swallow it by mistake, drink a lot of water or milk, and take some laxative such as vegetable oil and then immediately go to see a doctor.
- Keep electrolyte beyond reach of children.

Brake pad

Do not use an air hose or a dry brush to clean components of the brake system; use a vacuum cleaner or the equivalent to avoid dust flying.

Caution

Inhaling brake shoe or pad ash may cause disorders and cancer of the breathing system.

Brake fluid

Caution

Spilling brake fluid on painted, plastic, or rubber parts may cause damage to the parts. Place a clean towel on the above-mentioned parts for protection when servicing the brake system. Keep the brake fluid beyond reach of children.

1-03. Service Precautions

1. Always use with SMC genuine parts and recommended oils.
→ Using non-genuine parts for SMC ATV may damage the ATV and out of SMC warranty service.

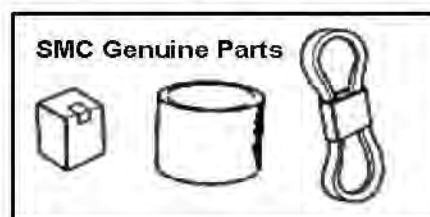

2. Special tools are designed for remove and install of components without damaging the parts being worked on. Using wrong tools may result in parts damaged.

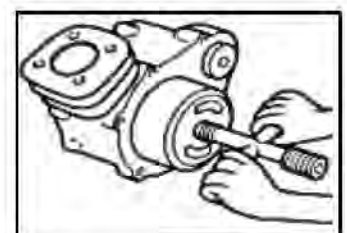

3. When servicing this ATV, use only metric tools. Metric bolts, nuts, and screws are not interchangeable with the English system, using wrong tools and fasteners may damage this vehicle.
4. Clean the outside of the parts or the cover before removing it from the ATV. Otherwise, dirt and deposit accumulated on the part's surface may fall into the engine, chassis, or brake system to cause damage.
5. Wash and clean parts with high ignition point solvent, and blow dry with compressed air. Pay special attention to O-rings or oil seals because most cleaning agents have an adverse effect on them.

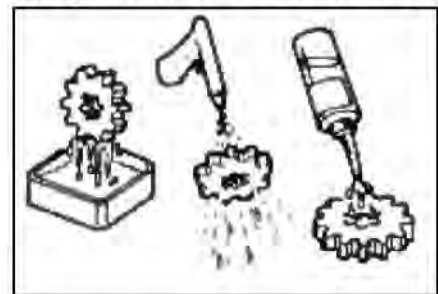

6. Never bend or twist a control cable to prevent unsmooth control and premature worn out.



7. Rubber parts may become deteriorated when old, and prone to be damaged by solvent and oil. Check these parts before installation to make sure that they are in good condition, replace if necessary.
8. When loosening a component which has different sized fasteners, operate with a diagonal pattern and work from inside out. Loosen the small fasteners first. If the bigger ones are loosen first, small fasteners may receive too much stress.
9. Store complex components such as transmission parts in the proper assemble order and tie them together with a wire for ease of installation later or you can label the assembly parts by Arabic number tab for the sequence to avoid the mistake.

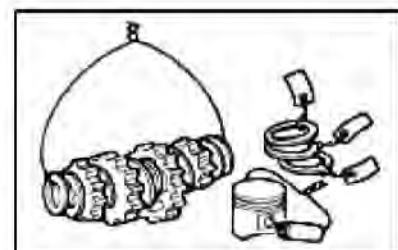

10. Note the reassemble position of the important components before disassembling them to ensure they will be reassembled in correct dimensions (depth, distance or position).

11. Components not to be reused should be replaced when disassembled including gaskets, metal seal rings, O-rings, oil seals, snap rings, and split pins.



12. The length of bolts and screws for assemblies, cover plates or boxes is different from one another, be sure they are correctly installed. In case of confusion, Insert the bolt into the hole to compare its length with other bolts, if its length outside the hole is the same with other bolts, it is a correct bolt. Bolts for the same assembly should have the same length.

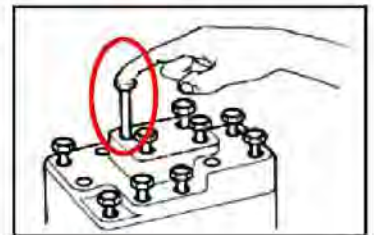

13. Tighten assemblies with different dimension fasteners as follows: Tighten all the fasteners with fingers, then tighten the big ones with special tool first diagonally from inside toward outside, important components should be tightened 2 to 3 times with appropriate increments to avoid warp unless otherwise indicated. Bolts and fasteners should be kept clean and dry. Do not apply oil to the threads.

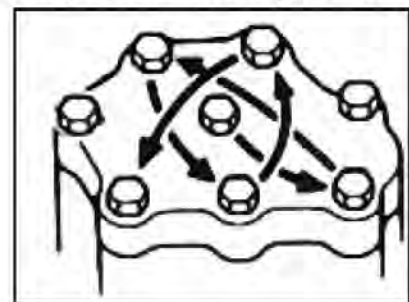

14. When oil seal is installed, fill the groove with grease, install the oil seal with the name of the manufacturer facing outside, and check the shaft on which the oil seal is to be installed for smoothness and for burrs that may damage the oil seal.

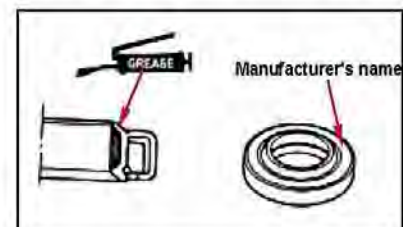

15. Remove residues of the old gasket or sealant before reinstallation, grind with a grindstone if the contact surface has any damage.



16. The ends of rubber hoses (for fuel, vacuum, or coolant) should be pushed as far as they can go to their connections so that there is enough room below the enlarged ends for tightening the clamps.

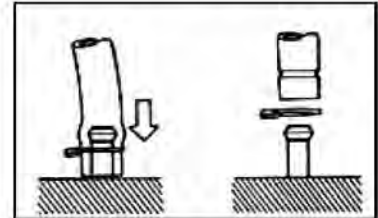

17. Rubber and plastic boots should be properly reinstalled to the original correct positions as designed.

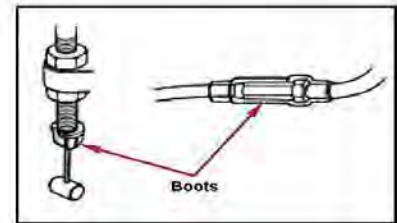

18. The bearing tool should be pressed against two (inner and outer) bearing races when removing a ball bearing. Damage may result if the tool is pressed against only one race (either inner race or outer race). In this case, the bearing should be replaced. To avoid damaging the bearing, use equal force on both races.

(Both of these examples can result in bearing damage)

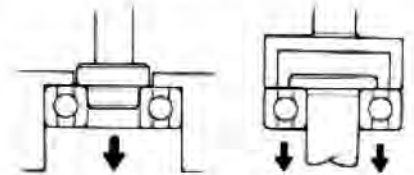

19. Lubricate the rotation ball face with specified lubricant on the lubrication points before assembling.

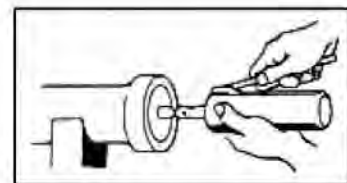

20. Check if positions and operation for installed parts is in correct and properly.

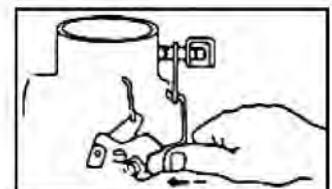

21. Make sure service safety for each other when conducting by two persons.

22. Do not let parts fall down.



23. Battery removal/installation.

- A. Before battery removal operation, it has to remove the battery negative (–) cable firstly. Tools like open-end wrench do not contact with body to prevent from short-circuit and create spark.

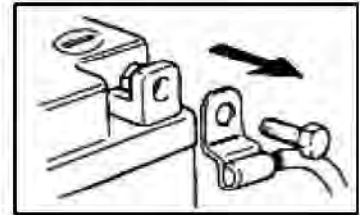

- B. After service completed, make sure all connection points is secured. Battery positive (+) cable should be connected firstly when re-install the battery cord. .

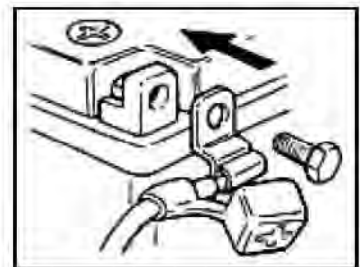

- C. And the two pole sides of battery have to be greased after connected the cables.

- D. Make sure that the battery post caps are located in properly after the battery posts had been serviced.

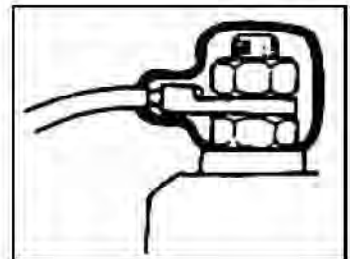

24. If fuse burned, it has to find out the cause and solved it. And then replace with specified capacity fuse.

25. Connector unlock/insert

- A. When separating a connector, it locker has to Insert the terminal completely, unlocked it first.

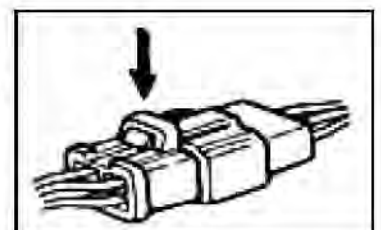

- B. Do not pull the wires as removing a connector or wires. Hold the connector body.



- C. Make sure if the connector pins are bent, extruded or loosen.

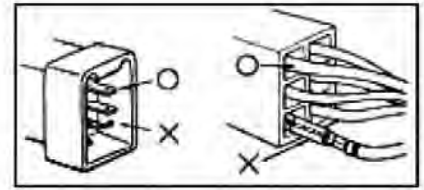

- D. Insert the connector completely. If there are two lockers on two connector sides, make sure the lockers are locked in properly. Check if any wire loose.

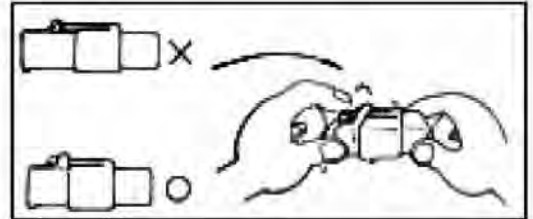

- E. Check if the connector is covered by the twin connector boot completely and secured properly.

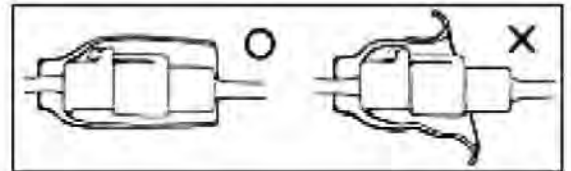

- F. Before terminal connection, check if the boot is crack or the terminal is loose.

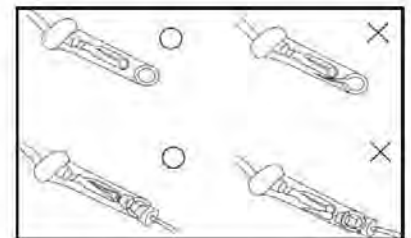

26. Secure wires and wire harnesses to the frame with respective wire bands at the designated locations. Tighten the bands so that only the insulated surfaces contact the wires or wire harnesses.

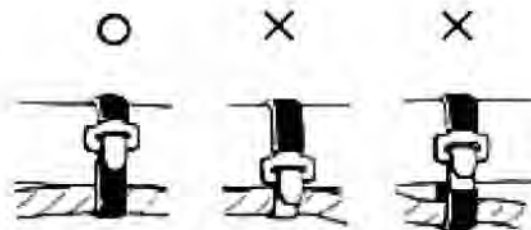

27. Wire band and wire harness have to be clamped secured properly.

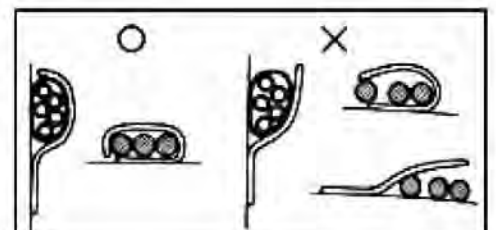

28. Do not squeeze wires against the weld or its clamp.



29. Do not let the wire harness contact with rotating, moving or vibrating components as routing the harness.

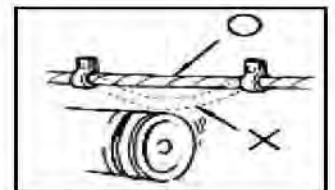

30. Keep wire harnesses far away from the hot parts.

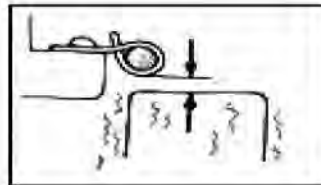

31. Route wire harnesses to avoid sharp edges or corners and also avoid the projected ends of bolts and screws.

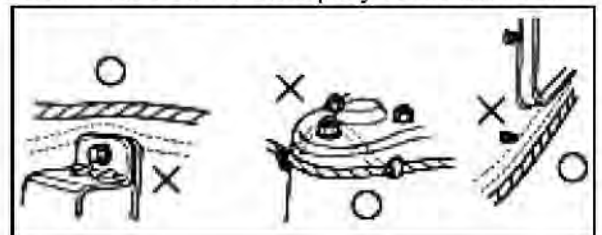

32. Route harnesses so that they neither pull too tight nor have excessive slack.

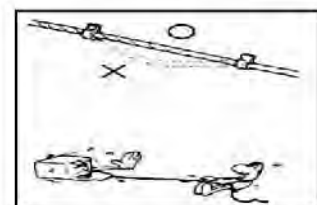

33. Protect wires or wire harnesses with electrical tape or tube if they contact a sharp edge or corner. Thoroughly clean the surface where tape is to be applied.

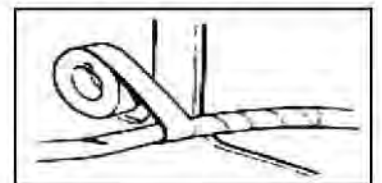

34. Secure the rubber boot firmly as applying it on wire harness.

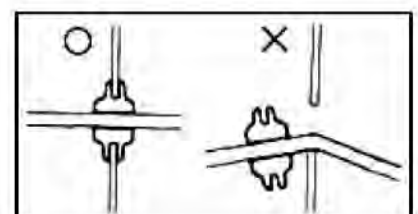

35. Never use wires or harnesses which insulation has been broken. Wrap electrical tape around the damaged parts or replace them.



36. Never clamp or squeeze the wire harness as installing other components.

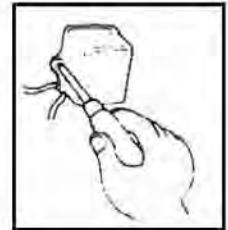

37. Do not let the wire harness been twisted as installation.

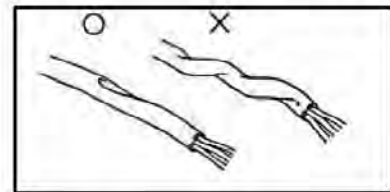

38. Wire harnesses routed along the handlebar should not be pulled too tight or have excessive slack, be rubbed against or interfere with adjacent or surrounding parts in all steering position.

39. Before operating a test instrument, operator should read the operation manual of the instrument. And then, conduct test in accordance with the instruction.

40. With sand paper to clean rust on connector pins/terminals if found. And then conduct connection operation later.



1-04 Specification

a. Jmax(i) 700 series

Dimension(LxWxH)	: 2125mm/1225mm/1245mm(701/702); 2125mm/1206mm/1150mm(701/702)
Seat height	: 930mm(off road); 890mm(off road)
Wheel base	: 1290mm
Ground Clearance	: 300mm(off road); 215mm(on road)
Weight	: Un-laden Mass = 320kg; with fuel Mass = 336 kg (701/702)
Un-laden Mass	= 343kg; with fuel Mass = 359 kg (701R/702R)
Engine	: SOHC 4 Stroke Liquid Cooled
Cylinder	: Single Vertical (Forward Inclined)
Bore * Stroke	: 100 x 86mm
Displacement	: 675cc
Compression Ratio	: 9.5:1
Lubricant	: Wet Sump
Fuel providing	: Carburetor: Mikuni BSR 42 (EEC model: MJ:#130; PJ:#45) : Fuel injection: Delphi (MT05)
Spark	: NGK CR7E x 1
Starting	: Electrical starter
Ignition	: C.D.I. / ECM
Generator	: ACG Fly Wheel Magneto 14V/16A above on 1,500 rpm
Engine Oil	: 4 Stroke Engine Oil, 10W40 API/SL or above, synthetic base is recommended.
Engine Oil	: At change (2.2L); at disassembly (2.5L) with oil filter; Oil filter cartridge=100cc
Air-Filter	: Wet type element
Transmission (F-R)	: C.V.T Automatic with centrifugal clutch.
Gear Shifting	: L-H-N-R-P (shift selector function in reverse with pedal brake)
Final Drive	: 3 ways (2WD, Limited slip 4WD, Differential lock 4WD) with shaft drive
Final gear box	: SAE 90 API; at change (0,29L) at disassembly (0,30L)
Differential gear box	: SAE 90 API; at change (0,29L) at disassembly (0,33L)
RPM limit	: Forward limited 7500 +/- 100 and Reverse speed on 15KM/HR.
Radiator (liquid coolant)	: 2,080 +/- 20 c.c. coolant (standard concentration 50%)
Reservoir tank coolant	: 300cc +/- 20 c.c. coolant (standard concentration 50%)
Fuel	: Unleaded gasoline (#95 Octane or above is recommended)
Fuel tank	: 24L
Chassis	: Steel tube frame
Front Suspension	: Independent, Double A-arm, 153 mm travel, 5-Section adjustable pre-loaded
Rear Suspension	: Independent, Double A-arm, 209 mm travel, 5-Section adjustable pre-loaded
Brake (F/R)	: Front dual hydraulic disc ϕ 220mm / Rear single hydraulic disc ϕ 200mm



Final Drive	: 3 ways (2WD, Limited slip 4WD, Differential lock 4WD) with shaft drive
Final gear box oil	: SAE 90 API; at change (0,29L) at disassembly (0,30L)
Differential gear box	: SAE 90 API; at change (0,29L) at disassembly (0,33L)
RPM limit	: Forward limited 7500 +/- 100 and Reverse speed on 15KM/HR.
Radiator (liquid coolant):	2080 c.c. coolant (standard concentration 50%)
Reserve tank coolant	: 300 c.c. +/- 20cc coolant (standard concentration 50%)
Fuel	: Unleaded gasoline (#95 Octane or above is recommended)
Fuel tank	: 24L
Chassis	: Steel tube frame
Front Suspension	: Independent, Double A-arm/153 mm travel, 5-Section adjustable pre-loaded
Rear Suspension	: Independent, Double A-arm/ 209 mm travel, 5-Section adjustable pre-loaded
Brake (F/R)	: Front dual hydraulic disc ϕ 220mm / Rear double hydraulic disc ϕ 200mm
F. Brake operation	: Front RH side handle brake lever for front wheeler
R. Brake operation	: Front LH side handle brake lever for rear wheeler; R side footrest brake pedal for integrate front and rear wheeler at the same time
Tire	: Tubeless
Front/Rear	: (F) AT 25x8-12 (for 12" wheel rim), or AT 26x8-14 (for 14" model) (R) AT 25x10-12 (for 12" wheel rim), or AT 26x10-14 (for 14" model)
Battery	: MF type 12V/18A, i.e. YUASA® YTX 20L-BS or GS Battery® GTX20L-BS
Head Light (701)	: (F. Double light) 12V 35W* 2 (Hi-Beam); 12V/55W*2 (Low- beam)
Head Light (70 2)	: (F. Square light) 12V 35/35W* 2 (Hi/Lo Beam)
Position lamp	: 12V 5W *2
Rear / Flasher Light	: 12V 21/18W* 2 ; 12V 10W* 4
Fuse	: Main (30A) / Headlight (15A) / A.DC Jack(10A) / Four-wheel-drive(10A) Signal system (10A) / Backup (30A/15A/10A)

PS: 701 = double f. light, 702 = square font light, R= Road type version

c. jMBX(i) 700

Dimension(LxWxH)	: 2130mm/1225mm/1260mm/2125mm/1206mm/1150mm
Seat height	: 907mm
Wheel base	: 1290mm
Ground Clearance	: 300mm(off road)
Weight	: Un-laden Mass = 320kg; with fuel Mass = 336 kg
Un-laden Mass = 343kg; with fuel Mass = 359 kg	
Engine	: SOHC 4 Stroke Liquid Cooled
Cylinder	: Single Vertical (Forward Inclined)
Bore * Stroke	: 100 x 86mm
Displacement	: 675cc



Compression Ratio	: 9.5:1
Lubricant	: Wet Sump
Fuel providing	: Carburetor: Mikuni BSR 42 (EEC model: MJ:#130; PJ:#45) :Fuel injection: Delphi (MT05)
Spark	: NGK CR7E x 1
Starting	: Electrical starter
Ignition	: C.D.I. / ECM
Generator	: ACG Fly Wheel Magneto 14V/16A above on 1,500 rpm
Engine Oil	: 4 Stroke Engine Oil, 10W40 API/SL or above, synthetic base is recommended.
Engine Oil	: At change (2.2L);at disassembly (2.5L) with oil filter; Oil filter cartridge=100cc
Air-Filter	: Wet type element
Transmission (F-R)	: C.V.T Automatic with centrifugal clutch.
Gear Shifting	: L-H-N-R-P (shift selector function in reverse with pedal brake)
Final Drive	: 3 ways (2WD, Limited slip 4WD, Differential lock 4WD) with shaft drive
Final gear box	: SAE 90 API; at change (0,29L) at disassembly (0,30L)
Differential gear box	: SAE 90 API; at change (0,29L) at disassembly (0,33L)
RPM limit	: Forward limited 7500 +/- 100 and Reverse speed on 15KM/HR
Radiator (liquid coolant)	: 2,080 +/- 20 c.c. coolant (standard concentration 50%)
Reservoir tank coolant	: 300cc +/- 20 c.c. coolant (standard concentration 50%)
Fuel	: Unleaded gasoline (#95 Octane or above is recommended)
Fuel tank	: 24L
Chassis	: Steel tube frame
Front Suspension	: Independent, Double A-arm, 153 mm travel, 5-Section adjustable pre-loaded
Rear Suspension	: Independent, Double A-arm, 209 mm travel, 5-Section adjustable pre-loaded
Brake (F/R)	: Front dual hydraulic disc ϕ 220mm / Rear single hydraulic disc ϕ 200mm
F. Brake operation	: Front RH side handle brake lever for front wheeler
R. Brake operation	: Front LH side handle brake lever for rear wheeler/parking brake; R side footrest brake pedal for integrate front and rear wheeler at the same time
Tire	: Tubeless
Front/Rear	: (F) AT 25x8-12 (for 12" wheel rim), or AT 26x8-14 (for 14" model) (R) AT 25x10-12 (for 12" wheel rim), or AT 26x10-14 (for 14" model)
Battery	: MF type 12V/18A, i.e. YUASA® YTX 20L-BS or GS Battery® GTX20L-BS
Head Light (701)	: (F. Double light) 12V 35W* 2 (Hi-Beam); 12V/35W*2 (Low- beam)
Head Light (702)	: (F. Square light) 12V 35/35W* 2 (Hi/Lo Beam)
Position lamp	: 12V 5W *2
Rear / Flasher Light	: 12V 21/18W* 2 ; 12V 10W* 4
Fuse	: Main (30A) / Headlight (15A) / A.DC Jack(10A) / Four-wheel-drive(10A) Signal system (10A) / Backup (30A/15A/10A)



Sprocket camshaft bolt	1	6	12	
Housing bevel bearing	4	8	32	
Housing output shaft	4	8	32	
Starting clutch ass'y	3	8	33	
Crankcase bolts	5	8	23	
Crankcase bolts	10	6	10	
Plate ventilation	7	4	5	
Pickup coil	2	5	8	
Other bolts	--	6	10	

B. Frame Torque

Item	Q'ty	Thread Dia. (mm)	Tor Value (N-m)	Remarks
Handlebar upper holder bolt	4	6	23	
Steering shaft nut	1	14	180	
Steering tie-rod nut	4	10	25	
Knuckle nut	4	10	48	
Steering shaft holder bolt	2	8	23	
Front wheel nut	8	10	55	
Front axle castle nut	2	18	260	
Rear axle castle nut	2	22	260	
Rear wheel nut	8	10	55	
Engine hanger nut	3	10	40	
Drive gear bolt	5	10	55	
Driven gear nut	4	10	55	
Front/Rear suspension arm bolt	8	10	45	
Front / Rear suspension arm nut	8	10	45	
Brake lever bolt	2	5	10	
Brake hose bolt	13	10	30	
Brake caliper bolt(front)	4	8	30	
Brake caliper bolt(rear)	2	10	45	
Air-bleed valve	2	5	5	
Exhaust muffler mounting bolt	2	8	20	
Exhaust muffler connection nut	2	8	15	

1-06.Troubles Diagnosis

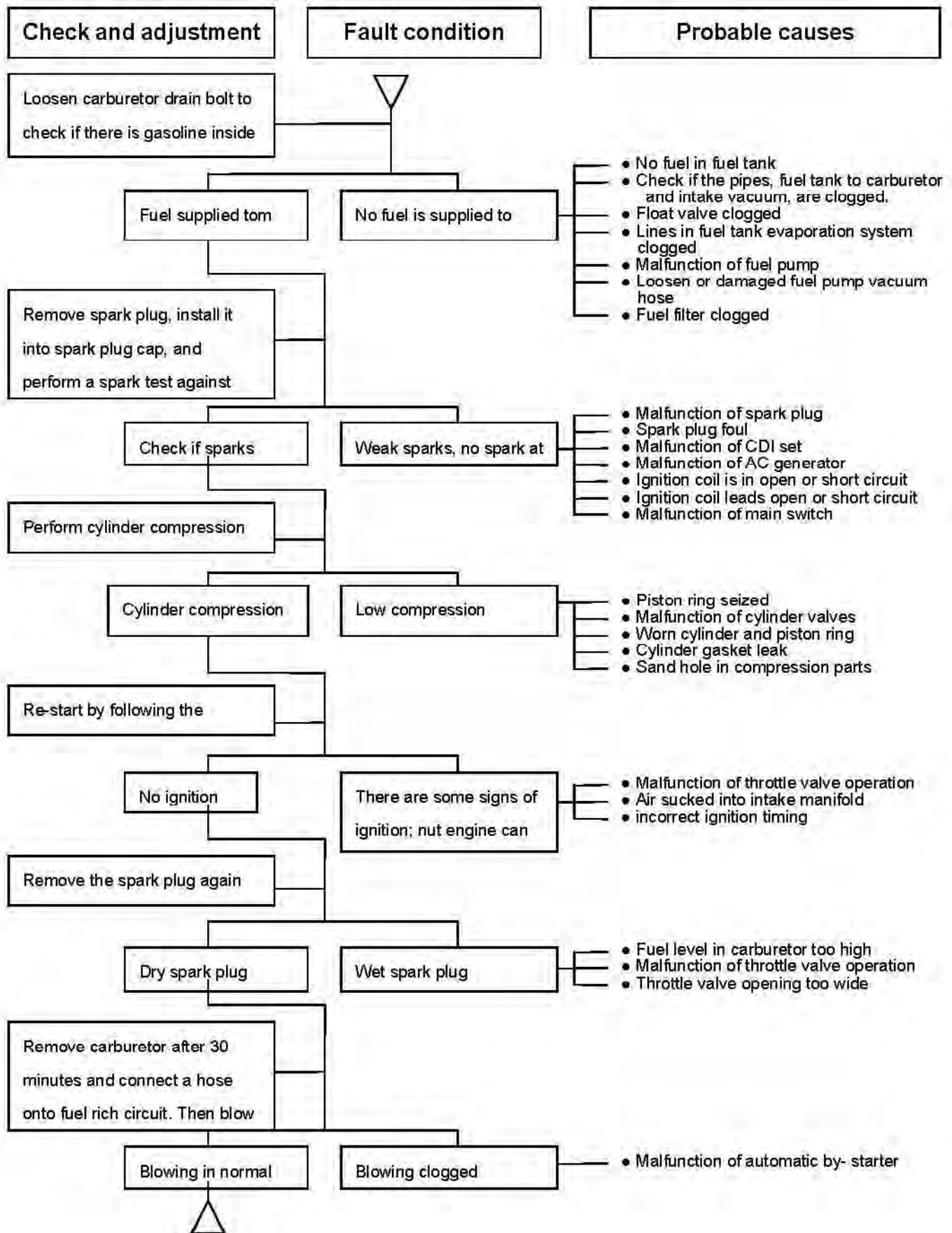
A. Engine hard to start or cannot be started

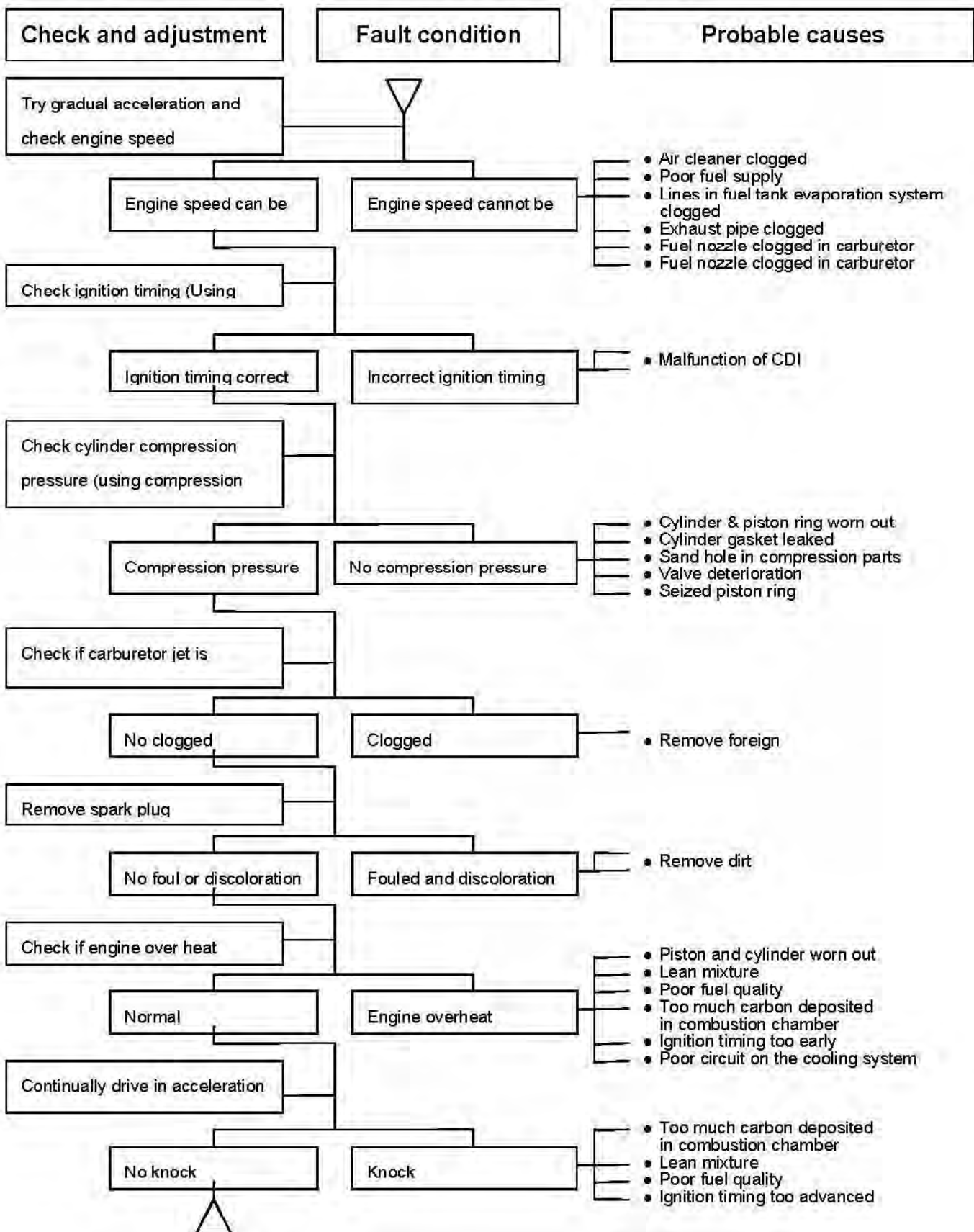
B. Engine run sluggish (speed does not pick up, lack of power)

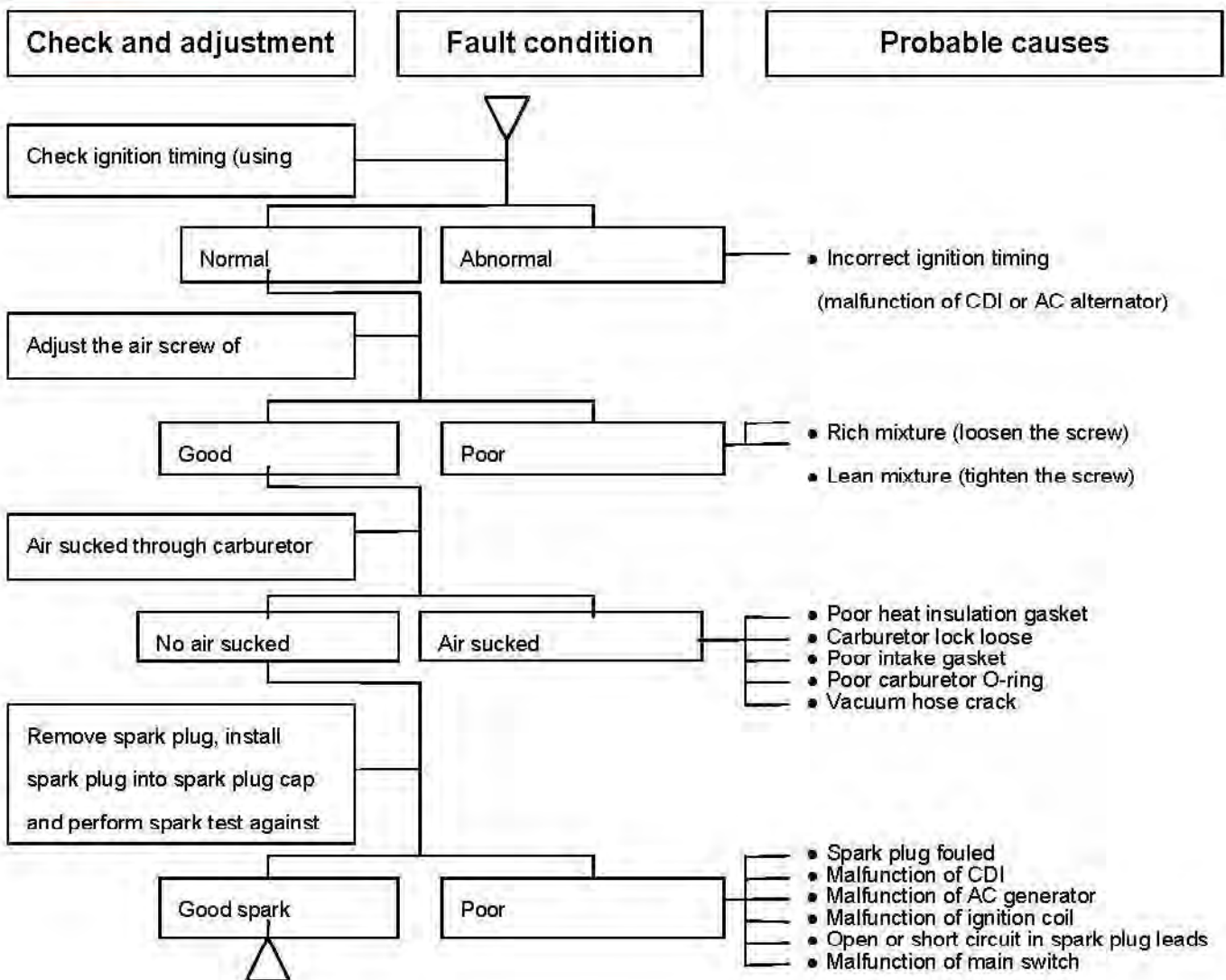
C. Engine runs sluggish (especially in low speed and idling)

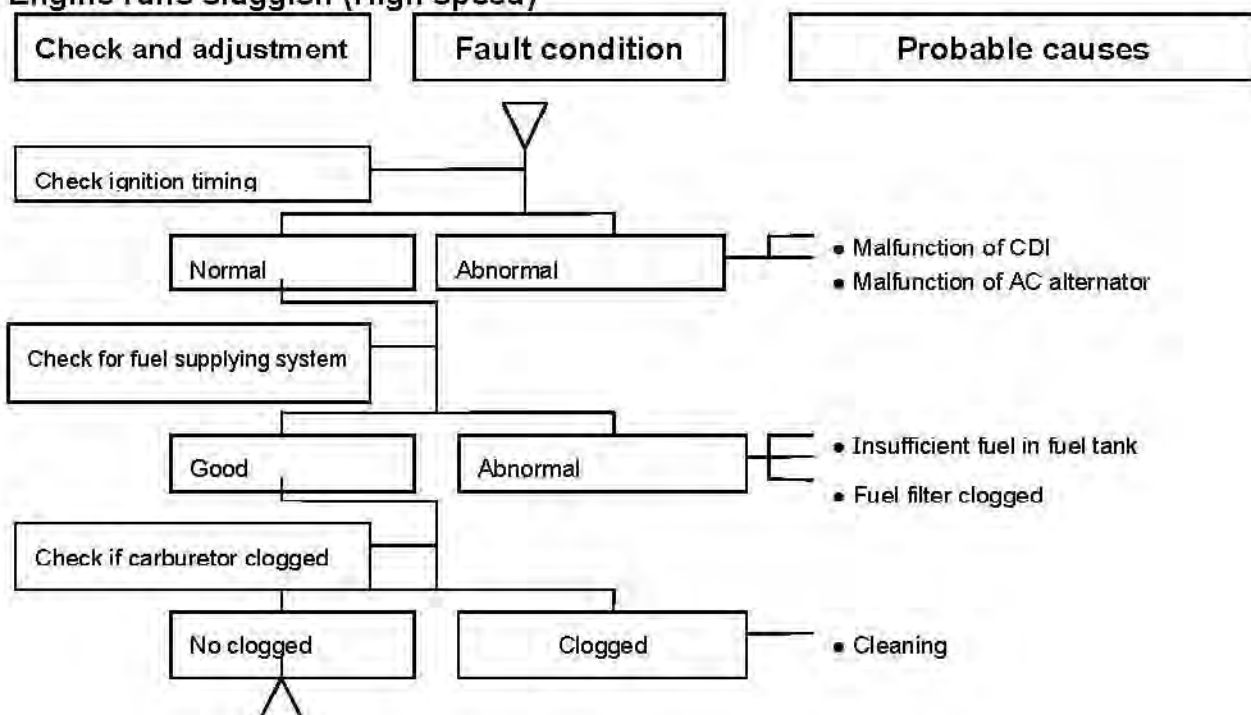

D. Engine runs sluggish (High speed)

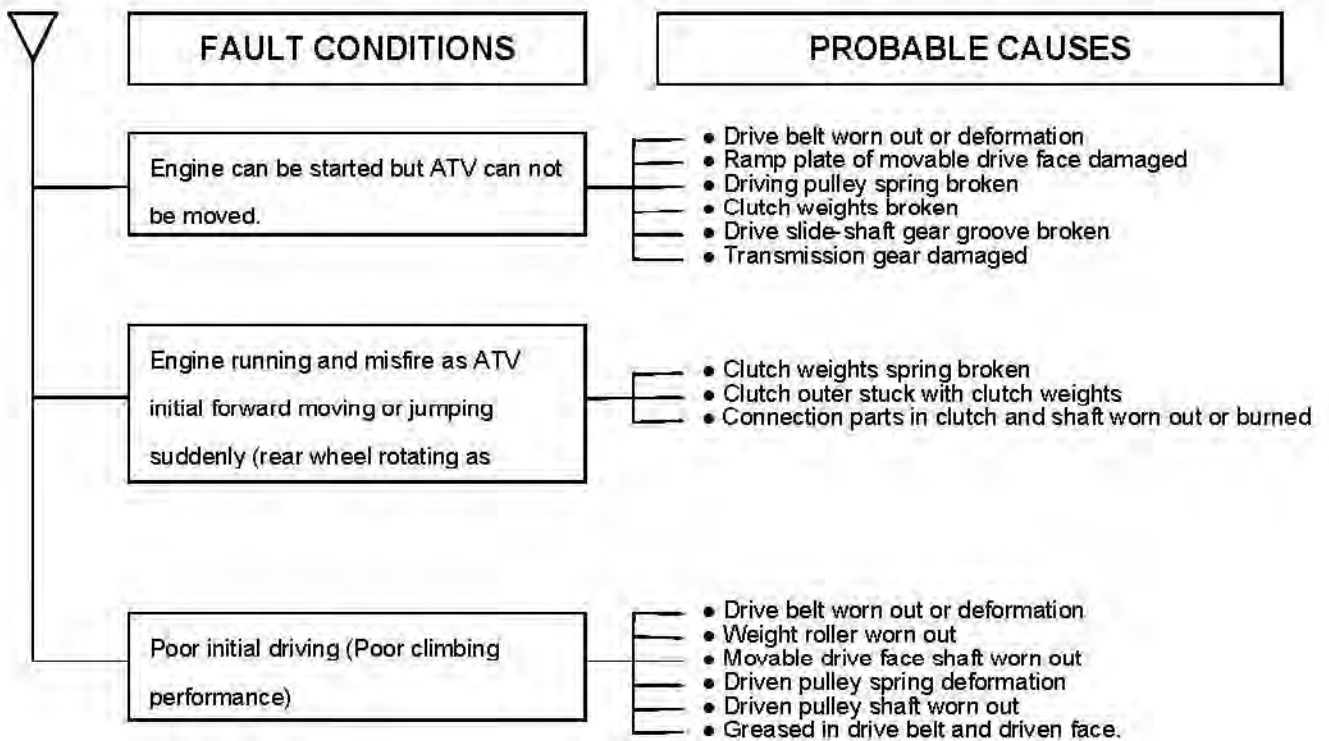
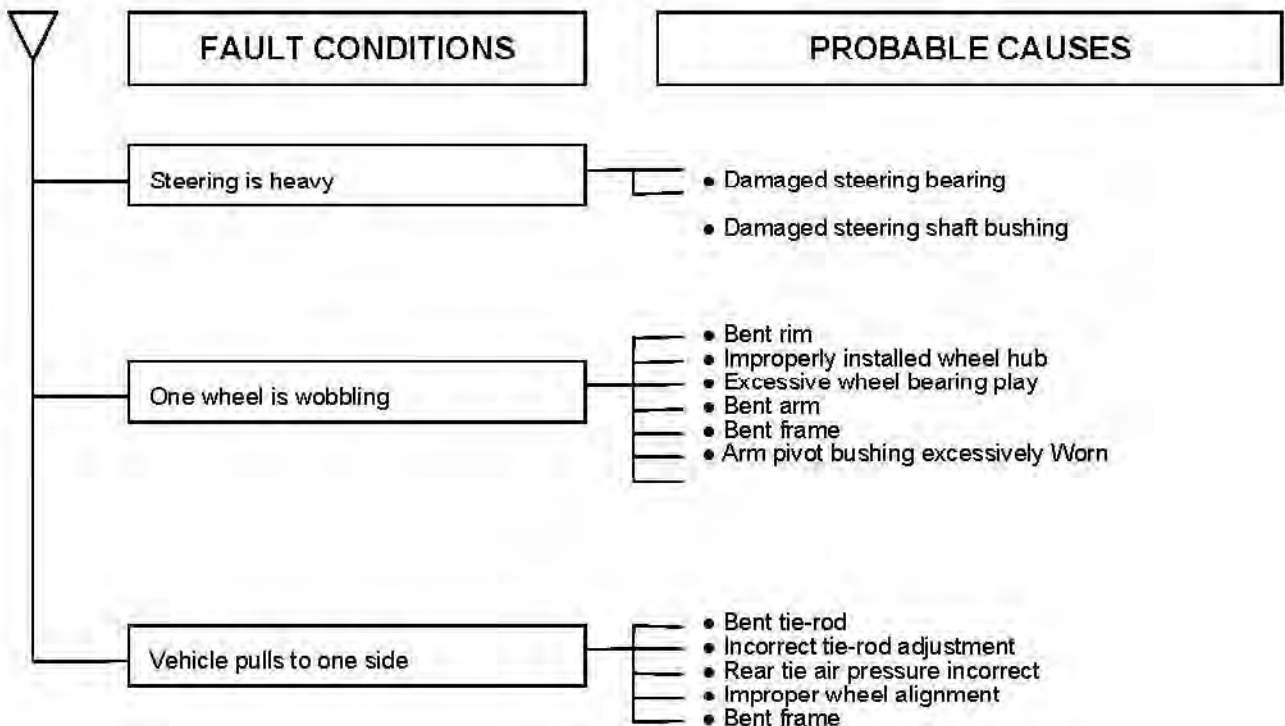

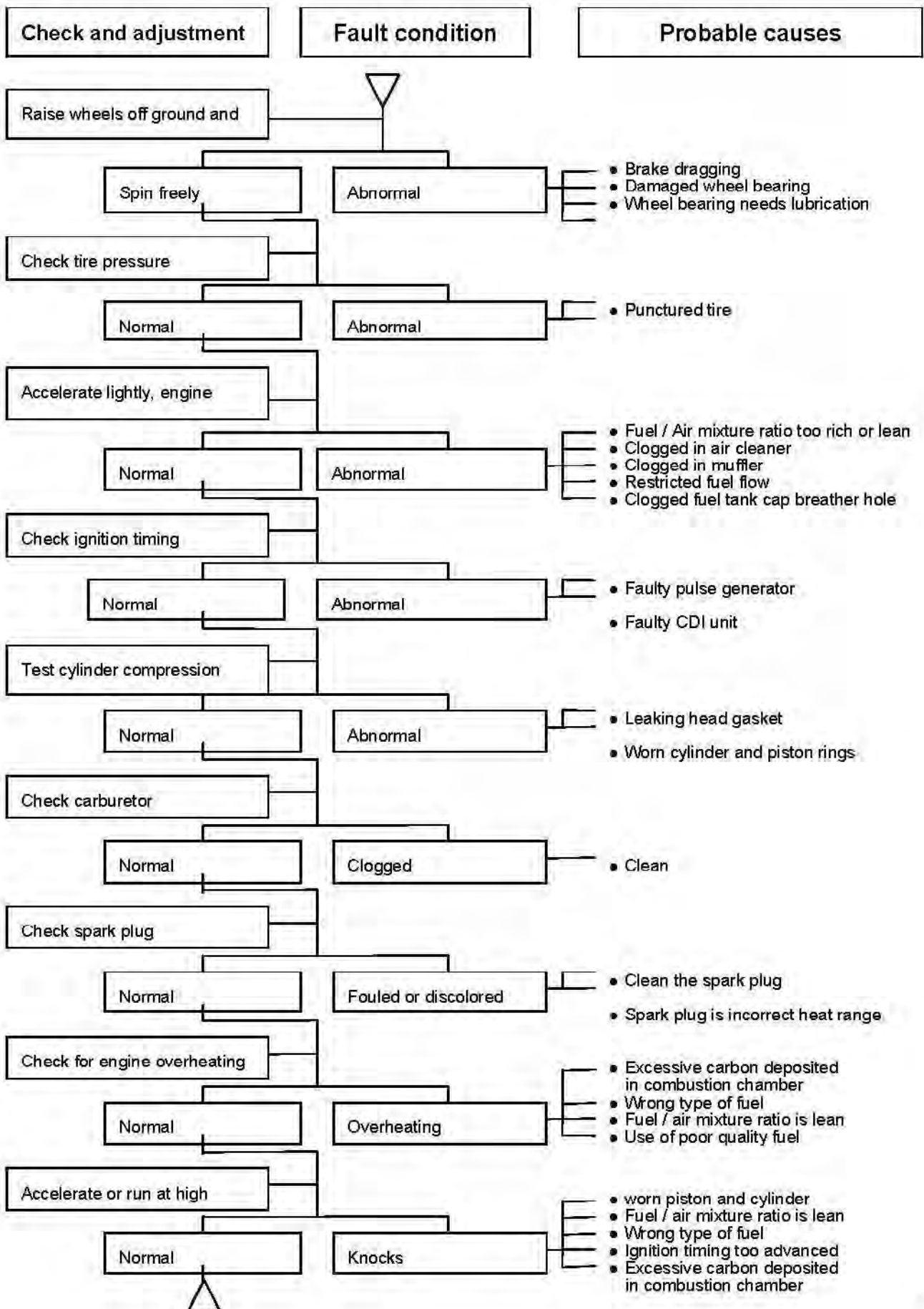
E. Clutch, driving and driving pulley

F. Poor handling

G.Loss power

Note:



- 2-01. Technical Data
- 2-02. Periodical Maintenance Schedule
- 2-03. Fuel Hoses
- 2-04. Throttle Cable
- 2-05. Air Cleaner
- 2-06. Spark Plug
- 2-07. Valve Clearance
- 2-08. Idle Speed Adjustment
- 2-09. Ignition System
- 2-10. Cylinder Compression Pressure
- 2-11. Drive Belt
- 2-12. Brake System (Disk Brake)
- 2-13. Brake Light Switch/Starting Inhibitor ...
- 2-14. Headlight Beam Distance
- 2-15. Clean Spark Arrester
- 2-16. Suspension
- 2-17. Steering Handle
- 2-18. Wheel/Tire
- 2-19. Check the Oil
- 2-20. Toe-in Adjustment
- 2-21. C.V. Joint Boot Check
- 2-22. Seat Opening & Installing
- 2-23. Nuts, Bolts Tightness
- 2-24. ECM
- 2-25. Fuel pump
- 2-26. Injector

2-01 Technical Data of Oil & Pressure Capacity

Fuel Tank Capacity		24000 c.c.
Engine Oil	Capacity	2500 c.c.
	Change	2200 c.c.
	Oil and oil filter change	2300c.c.
Front differential oil	Capacity	330c.c
	Change	290c.c
Rear gear box oil	Capacity	300 c.c.
	Change	290 c.c.
Capacity of coolant	Engine + radiator + hoses	2500 c.c.
	Reservoir upper	300 c.c.
Clearance of throttle valve		1~3 mm
Spark plug	Type	NGK CR7E
	Gap	0.7~0.8 mm
"F"Mark in idling speed		BTDC 10°/ 1500 rpm
Full timing advanced		BTDC 24°/ 6200 rpm
Idling speed		1600±100 rpm(NA for EFI)
Cylinder compression pressure		12±2 kgf/cm ²
Valve clearance		IN:0.10 ±0.02 mm EX:0.15 ±0.02 mm
Tire dimension	Front	AT25x8-12 / AT26x8-14 or other
	Rear	AT25x10-12 /AT26x10-14 or other
Tire pressure (cold)		8(7)±0.2 psi (On road) / 5(3.5) ±0.2 psi (Off road)
Battery		12V18Ah (type : MF battery)

2-02 Periodical Maintenance Schedule

Have your ATV checked, adjusted, and recorded maintenance data periodically by your SMC Authorized Dealer to maintain the ATV at the optimum condition. The above maintenance schedule is established by taking the hours or kilometers as a reference whichever comes first.

Item	Check Items	Maintenance Kilometer	300KM	1000KM	2500KM	Every 2500KM	Every 5000 KM	Remarks
		Maintenance Interval	20 hr	60 hr	150 hr	150 hr	300hr	
Engine maintenance								
1		Engine oil (Check oil level every 1000~1200KM or after 1500 KM travel)	R	R	R	R	R	
2		Engine Oil filter Cartridge	R	R	R	R	R	
3	*	Engine idle speed						
4	*	Valve clearance						
5	*	Ignition timing/Cam Chain						
6		Spark plug check or change						
Fuel and air system								
7		Air cleaner element (Remark)	Clean and replace if necessary for Every 20~40 hours (more often when in wet or dusty areas)					
8	*	Air Cleaner Breather tube						
9	*	Carburetor /Choke/ Engine idle Speed						
10	*	Throttle operation /Speed limiter						
11	*	Fuel lines (check or cracks/damage)						
12	*	Fuel filter						
Frame/Steering/Suspension/Brake/ Wheel & Tires								
13	*	Upper and low A-Arm						
14	*	Steering Shaft (lubricant, Toe in check)			I/L	I/L	I/L	
15	*	Front and Rear shock absorber check						
16	*	Front /Rear brake free play check						
17	*	Front / Rear brake wear	Replace whenever worn to the limited					
18	*	Front and Rear Brake Fluid Level/Leakage Check						
19	*	Wheel rim check for damage						
20	*	Wheel Hub Bearing looseness/damage						
21	*	Tire (Wear/Pressure)						
22	*	Nuts, Bolt, Bush, fastener check and lubricant.						
23	*	Engine Mount check						

24	*	Fr. & Rr. Steering Knuckle pivot	L	L	L	L	L		
25	*	Parking Brake/Throttle cable	I/L	I/L	I/L	I/L	I/L		
26		Stabilizer bushes			I	I	I		
Transmission									
27		Differential gear oil	I			I	R		
28		Final gear oil	I			I	R		
29	*	Axle boots	I	I	I	I	I		
30	*	CVT driving belt/weight rollers	I			I	I		
31	*	CVT driving Clutch	I			I	I		
Liquid Cooling system									
32		Radiator (coolant level, flow, leakage)	I	I	I	I	I		
33		Coolant reservoir (level, leakage)	I	I	I	I	I		
34		Coolant	Change every 2 years						
35	*	Cooling Fan function/ Hose leakage	I	I	I	I	I		
Electrical System									
36		Multi-function LCD Display (dashboard/speedometer)	I	I	I	I	I		
37	*	Lights /electrical equipment	I	I	I	I	I		
38	*	Front and rear brake switch	I	I	I	I	I		
39		Battery Voltage	I	I	I	I	I		
EFI System									
40		Fuel pump ass'y	I	I	I	I	R		
41		Fuel delivery hose	I	I	I	R	R		
42		Throttle Body	I	I	I	C	C		
43		Lean (tilt) switch		I	I	I	I		
44		O ² sensor	I	I	I	I	R		
45		ECM/TPS/CTS/ETS	I	I	I	I	I		

Code: I ~ Inspection, cleaning, and adjustment R ~ Replacement
C ~ cleaning (replaced if necessary) L ~ Lubrication

Remarks:

1. Air cleaner needs to be cleaned every 20-40 hrs drive and requires more frequently cleaning or replacement after riding on (1) dusty rain days (2) sand area (3) snow days.
2. Maintenance should be performed more often if the ATV is frequently operated in high speed and after the ATV has accumulated a higher mileage.
3. Check battery (18A) before riding ATV. Re-charge battery or replace a new battery, if it necessary.
4. Always keeps the coolant level between Max. and Min. mark (coolant reservoir), replace or add

coolant or distilled water, if it necessary. Replace all new coolant every 12-16 months! Only use the distilled water to mix coolant (standard concentration 50%)

5. Preventive maintenance

- a. Ignition system: perform maintenance and check when continuous abnormal ignition, misfire, after-burn or overheating occurs.
- b. Carbon deposit removal: remove carbon deposits in cylinder head, piston heads, exhaust system when power is obvious lower than ever.

6. Fuel pump ass'y for EFI need to be replaced the whole set within 3~4 year working period.

7. EFI system related periodical maintenance refer to Chapter 19.

- CAUTION: The user must perform the period check & service and keep the service records all the time, or have SMC dealer for a periodic maintenance program. Failure to follow the periodic maintenance of your vehicle will lead to poor performance, broken of your vehicle and out of product warranty.

- CAUTION: At once, “ check engine warning lamp “ turn on, stop engine and find out the fault reason then exclude the problems shown up in OBD (on-board diagnosis), re-start engine, refer to 19-03/19-04/19-18.

-NOTE: The display of speedometer have been designed a “ wrench” shown up in every 150 hours engine running. It reminds you to process necessary period check & service.

2-03 Fuel Hoses

Carburetor: Remove fuel tank cover. Loosen screws and bolts, Remove the tank cover, check all lines, and replace it when they are deterioration, damage or leaking

EFI system: Ensure all lines are all clamped & fixed well and replace it when they are deterioration, damage or leaking (refer to 19-09).

Warning

Gasoline is a low ignition material, any kind of fire is strictly prohibited as dealing it.

2-04 Throttle Cable

Have a wide open of throttle valve as handle in any position and release it to let back original (full Closed) position.

Check handle-bar operation if it's smooth. Check acceleration cable and replace it if deteriorated, twisted or damaged.

Lubricate the cable if operation is not smooth. Measure the throttle lever free play in its flange part.

Remove rubber boot, loosen fixing nut, and then adjust it by turning the adjustment screw. Tighten the fixing nut, and check acceleration operation condition.

Free play: 1~3 mm.

2-05. Air Cleaner

Remove seat, loosen 6 clamps from the air cleaner cover and then remove the cover. Separate the protective wire net and remove

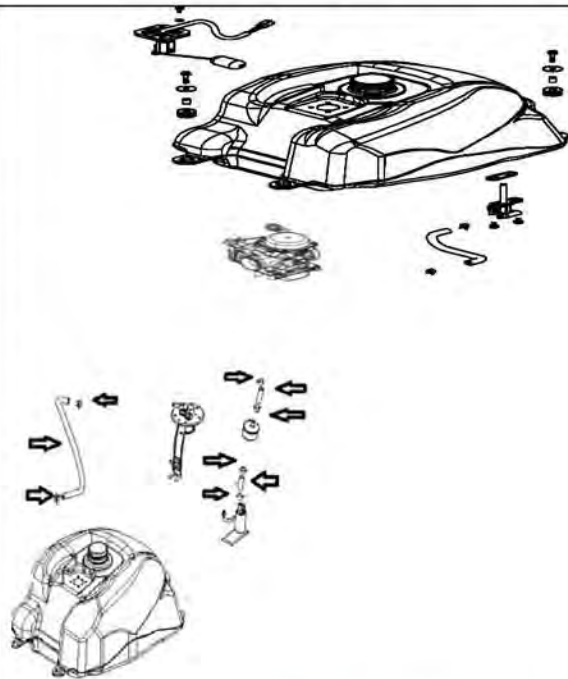

the air cleaner element.

Clean the element with non-flammable or high-flash point solvent and then squeeze it for dry.

Install back the element, ensure yellow side up.

Caution

Never use gasoline or acid organized solvent to clean the element.

Soap the element into cleaning engine oil and then squeeze it out. Install the element onto the element seat and then install the air cleaner cover.



1. Protective wire

2-06. Spark Plug

Recommended spark plug : NGK- CR7E

- a. Remove spark plug cap.
- b. Clean dirt around the spark plug hole.
- c. Remove spark plug.
- d. central electrode color checking.
 - normal color is a medium-to- light tan color.
- e. Measure spark plug gap.

Spark plug gap 0.7 ~0.8 mm

- f. Carefully bend ground electrode of the plug to adjust the gap if necessary.
- g. Hold spark plug washer and install the spark plug by screwing it.
- h. Tighten the plug by turning 1/2 turn more with plug socket after installed.

Tighten torque: 1.2kgf-m

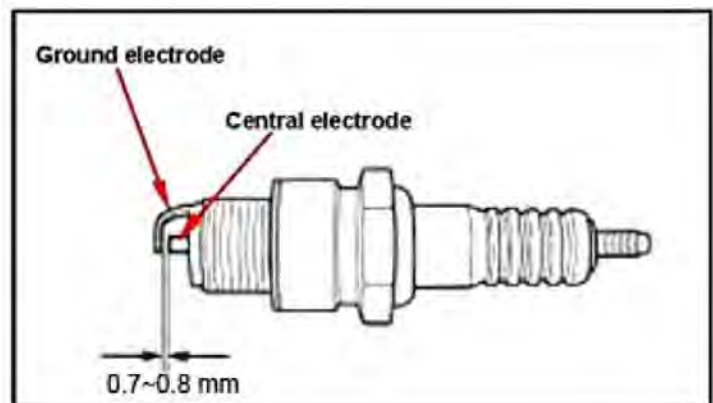

2-07. Valve Clearance

Caution

Checks and adjustment must be performed when the engine temperature is below 35°C.

- a. Remove necessary covers & spark plug.
- b. Remove cylinder head cover.
- c. Remove cylinder head side cover.
- d. Turn crankshaft in C.W. direction, i) align the "I" T on the rotor with the pointer on the cover ii) and align the "I" mark on the camshaft sprocket to the pointer "·" on cylinder head, the piston is at the TDC in compression stroke.

Caution

- Do not turn the bolt in C.C.W. direction.
- When piston is at the TDC on the compression stroke, there should be clearance between valve stem tips and rocker arm adjusting screws. If no, rotate crankshaft one turn.

Valve clearance inspection and adjustment.
Check & adjust valve clearance with feeler gauge.

Standard Value: IN 0.10 ± 0.02 mm
EX 0.15 ± 0.02 mm

- e. Loosen fixing nut and turn the adjustment nut for adjustment.

Caution

Re-check the valve clearance after tightened the fixing nut by rotating crankshaft two turns.



Align "I" "T"



Align "I" "·" to "·" "·"



2-08. Idle Speed/ Adjustment

Carburetor:

Caution

Inspection & adjustment for idle speed have to be performed after all parts in engine that needed adjustment have been adjusted. Idle speed check and adjustment have to be done after engine is being warm up.

1. Warm up the engine and turn-off.
2. Turn the Idle adjust screw (right side of engine) clockwise until it is lightly seated.
3. Loosen the Idle adjust screw by turning it counterclockwise 1-1/2.
4. Start the engine and switch the dashboard to RPM display mode. (or use tachometer to connect to spark plug end to read RPM)
5. Start the engine and adjust the throttle until around 1,600 +/- 100 rpm.
6. Check and re-adjust the idle speed with the idle speed..

Specified idle speed:

1600 ± 100 rpm

EFI system:

Caution

Do not adjust idle speed unless a overhaul taken.

EFI system idle speed (1600±100 rpm) have been fixed in factory and not allow to be adjusted. The idle speed screw have been mark a special paint.

Refer to 19-07/19-03.



2-09. Ignition System

Caution

Engine idling speed and throttle cable free play should be adjusted properly before checking.

Connect tachometer and ignition light.

EFI system idle speed is fixed in built-in (refer to 19-11).

Start engine.

As engine in stable idle speed, aim at the mark "T" on the rotor with the ignition light.

If ignition timing is incorrect, check CDI set, pulser coil of generator. Replace it if malfunction of these parts is found.

2-10. Cylinder Compression Pressure

- a. Warm up engine.
- b. Turn off the engine.
- c. Remove spark plug cap and spark plug
- d. Install compression gauge.
- e. Crank the engine with the electric starter with throttle wide-open until the compression reading on the gauge stabilizes.

Caution

Usually, the highest pressure reading will be obtained in 4~7 seconds.

Compression pressure: $12 \pm 2 \text{ Kg/cm}^2$

Check following items if the pressure is too low:

- a. Incorrect valve clearance.
- b. Valve leaking.
- c. Cylinder head leaking
- d. Piston, piston ring and cylinder worn out.

If the pressure is too high, check carbon deposits in combustion chamber or piston head.

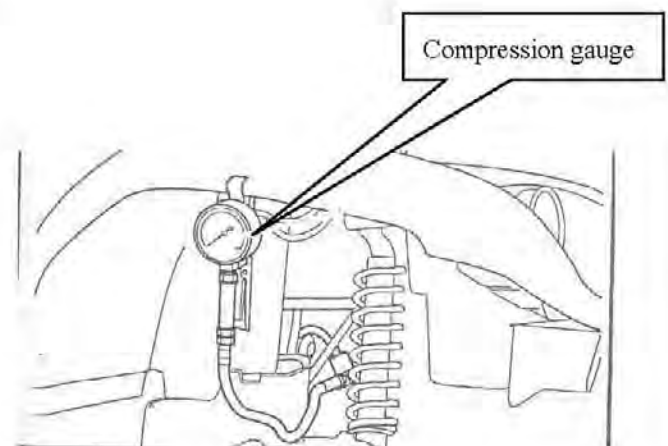
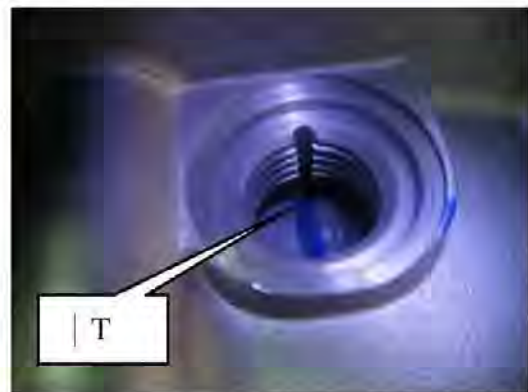

2-11. Drive Belt

- a. Release all necessary clamps, ducts & parts.
- b. Remove left crankcase cover bolts.
- c. Remove the Moveable driving face.
- d. Install the bolts into the driven sheave ass'y and tighten the bolts, causing the gap to loosen the belt then remove the belt.

Inspection

Check the drive belt for crack or wear. Replace it if necessary. Measure the width of drive belt as diagram shown.

Service Limit: 28.3 mm(width)

Replace the belt if it's out of specification.

Caution

- Using the SMC genuine parts for replacement.
- The surfaces of drive belt or pulley must be free of grease.
- Clean up all grease or dirt before installation.
- Install back the belt with mark side-up.
- Turn the belt forward for checking movement after finish installing.

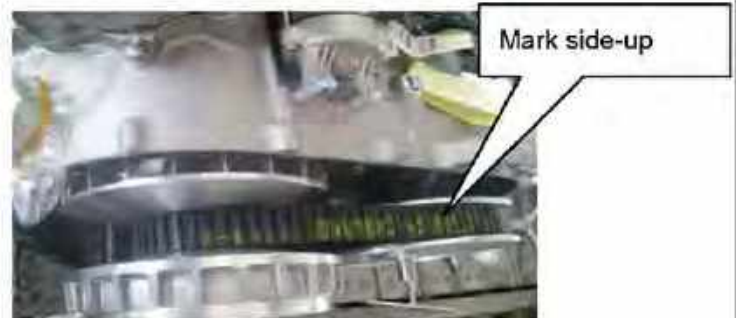
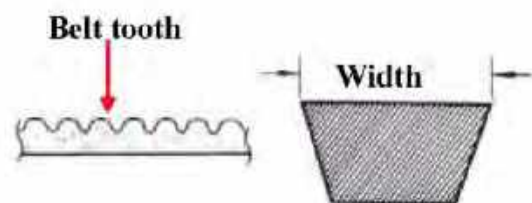
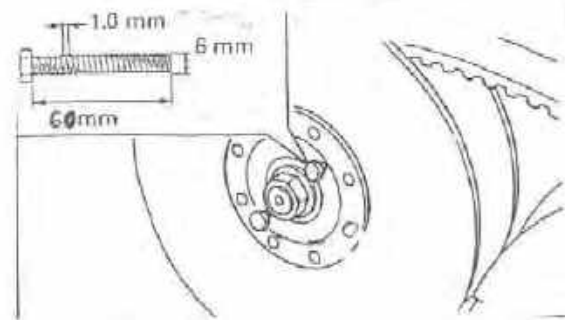

2-12. Brake System (Disk Brake)

Brake System Hose

Make sure the brake hoses contain no corrosion or leaking oil.

Brake Fluid

Make sure the brake fluid reservoir top is horizontal. Then check brake fluid level in the brake fluid reservoir. If the level is lower than the LOWER limit, add brake fluid to UPPER limit. Also check brake system for leaking if low brake level found.

Caution

- Brake fluid may damage plastic parts. Always clean up spilled brake fluid right away.
- Do not operate the brake lever after the cap had been removed. Otherwise, the brake fluid will spread out if operate the lever. Do not mix non-compatible brake fluid together.

Air Bleed / Brake fluid Change Operation

- Open the rubber cap of draining valve on the caliper.
- Connect a transparent hose to draining valve.
- Loose the drain valve.
- Repeat pressing the brake lever and check the fluid that out of caliper, inspect if there still any air bubble being bleed out. Be careful to add the fresh brake fluid on the master cylinder side at same time to avoid extra air into the brake system. Perform this operation until there is no air inside the

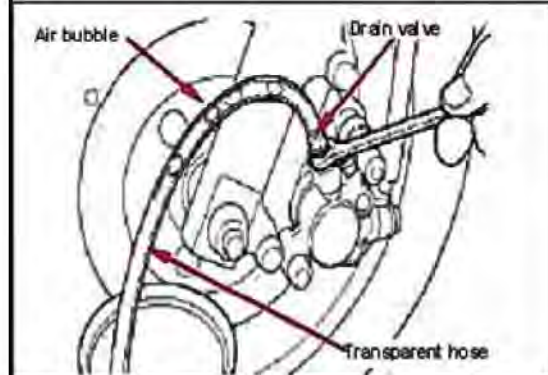
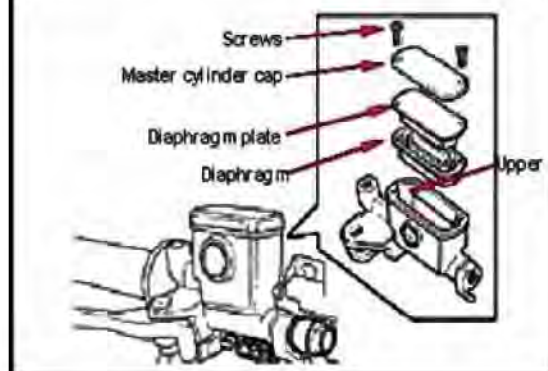
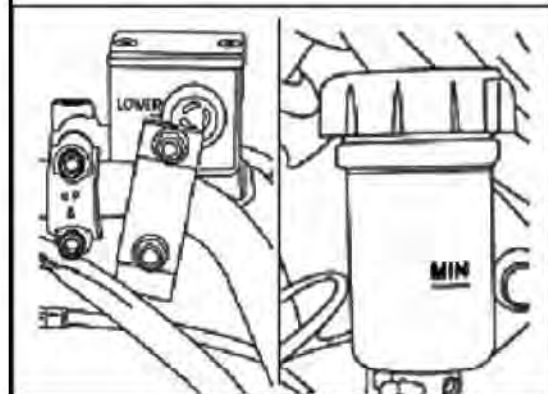

brake system hoses. A vacuum machine applied will be very helpful.
 e. Closed the drain valve

Added Brake Fluid

Add brake fluid to UPPER limit level.

Recommended brake fluid: DOT4

Caution

- Use only the designed quality brake fluid; other brake fluids may deteriorate the rubber seals, causing leakage and poor brake performance.
- Refill with the same type of brake fluid; mixing brake fluids may result in a harmful chemical reaction and lead to poor brake performance.
- Be careful that water does not enter the brake master cylinder when refilling.

Brake Lining Wear

The indicator mark on brake lining is the wear limitation (1mm).

Replace the brake lining pad if the wear limit mark closed to the edge of brake disc.

Caution

To check front brake lining must be remove front wheel first.

Note:

It is not necessary to remove brake hose when replacing the brake lining.



Front Brake



Rear Brake

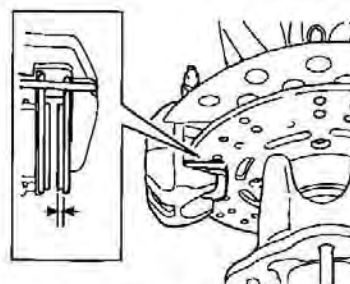

Check brake lining

Brake Pads Replacement (refer to Chapter 14)

Make sure the brake lining condition. Replace the lining pads if the brake lining wear limitation groove close to the brake disc.

Caution

Do not operate the brake lever after the caliper being removed to avoid pushing out piston. Be sure the brake pads must be replaced by one set.

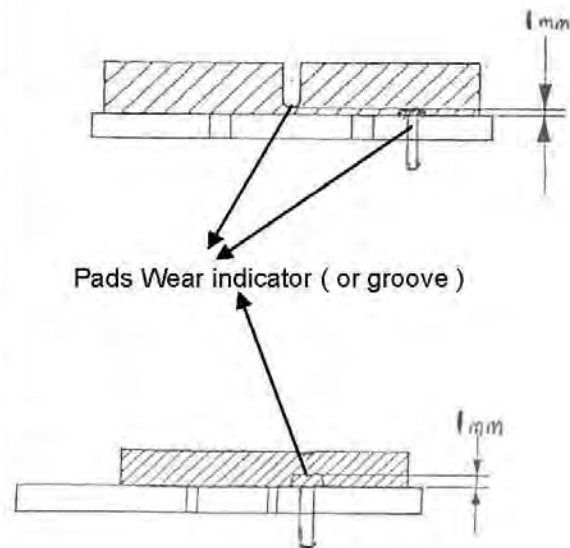

2-13. Brake Light Switch/Starting

Inhibitor Switch

The foot brake light switch is operated by movement of brake pedal. A proper adjusting is necessary when the brake light comes on just before the braking effect starts.

The hand brake light switch is operated by lever movement.

Make sure that electrical starter can be operated only under brake applying.



2-14. Headlight Beam Distance

Turn on main switch

Headlight beam adjustment. Turn the headlight adjusting screw to adjust headlight beam high.

Caution

To adjust the headlight beam follows related regulations.

Improper headlight beam adjustment will make in coming driver dazzled or insufficient lighting.

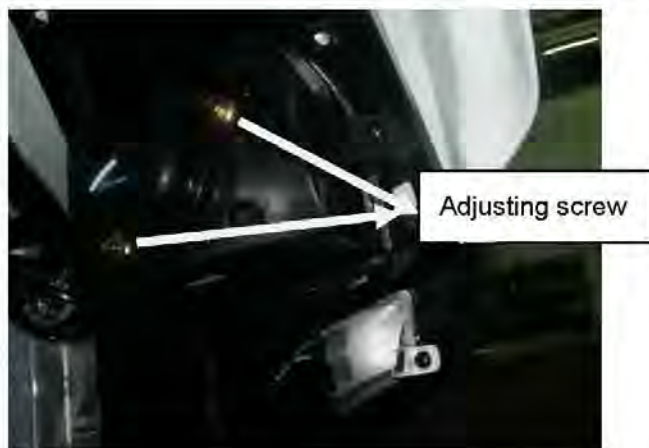

2-15. Cleaning Spark Arrester

Warning

- Always let the exhaust system cool before performing this operation.
- Do not start the engine when removing the tailpipe.

Cleaning step

- a) Remove the bolts
- b) Remove the gasket and tailpipe out of muffler.
- c) Use a wire brush to remove any carbon deposits from spark arrester portion of tailpipe and the inner contact surfaces of the muffler.
- d) Replace a new gasket
- e) Insert back the tailpipe to muffler and align the bolt hole
- f) Tighten the bolts

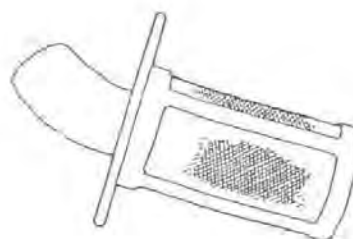

Note:

The arrester may have different type according requests.

2-16. Suspension / Adjustment

Warning

- Do not ride the ATV with poor suspension. Looseness, wear or damage suspension will make poor stability and drive-ability.
- Always adjust both shock absorbers spring preload to the same setting. Uneven adjustment can cause poor handling and loss of stability.

Adjustment:

Normal shock:

Use a wrench to turn the adjuster to increase or decrease the spring preload.

Standard position: 2

Min(soft) position: 1

Max(hard) position: 5

Nitrogen shock:

1) loading adjusting: use a wrench to turn the adjuster to increase or decrease spring preload.

2) damping adjusting: adjust "press side" by turning the upper adjuster cap (s=> soft, h=>hard). To adjust "pull side" by turning lower adjuster screw.

Check & Replacement :

Suspension

- Press down the front/rear suspension for several times to check its operation.
- Check if it is damaged (oil leaking / bad bound & rebound/bend)
- Replace relative parts if damage found.

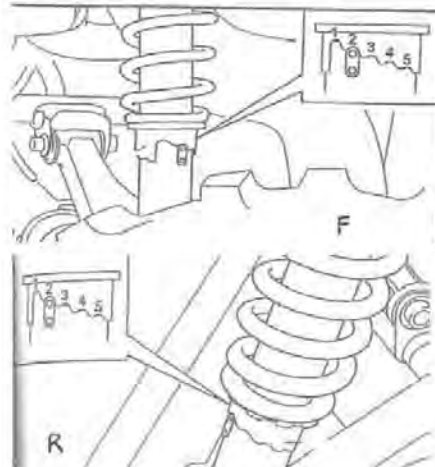

2-17. Steering Handle

1. Place the machine on a level surface.

- Check steering assembly bushings
 - ⇒ Move the handlebar up and down, and /or back and forth.

Excessive free play → Re-screw the bushings or Replace the steering bushings.

- Check the tie-rod ends
 - ⇒ Move tie rod vertically

Excessive free play → replace the tie rod ends.(the arrow shown)

2. Lift the front wheel out of ground.

- Check all wires and cables if they are interfered with the rotation of steering handle bar.
 - ⇒ Turn handle from right to left alternative and check if turning is smoothly.
 - Check the ball joints and/or wheel bearings.
 - ⇒ Move the wheels laterally back and froth.
- Excessive free play → replace the front arms and/or wheel bearings.



Steering bushings

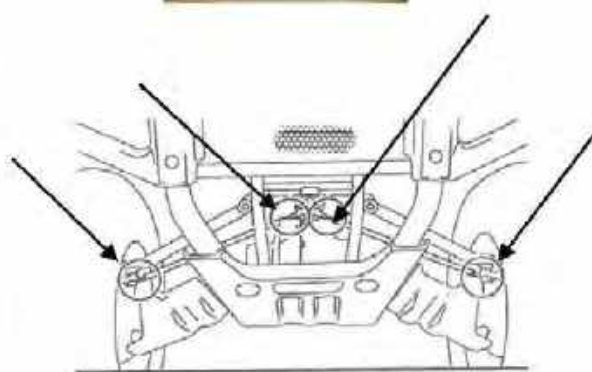

2-18. Wheel/Tire

Caution

- The vehicle is equipped with low pressure tires. It's important that they be inflated correctly and maintained at the proper pressures.
- Tire pressure check should be done before riding.
- Follow the size and characteristics as recommended when the tires need to be replaced

Checking the tires

1. Check if tire surface is ticked with nails, stones or other materials.
2. Check the tire pressures by tire gauge. Out of specification → set the proper pressures when tires are cold. Tires pressures should be equal in both tires in front and in rear.

Tire pressure: As recommend in warning labels on the model.

3. Measure tire groove depth from tire central surface. Replace the tire if the depth decrease to 3mm due to wear.

Front & rear tire groove depth limit: 3mm

Checking the wheels

Caution

Never attempt repairs to the wheel.

Check the wheels if damage/bends → replace

2-19. Check the oil

Always place the machine on a level surface, then check the oil..

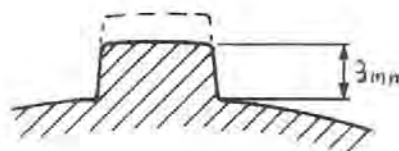

- Engine oil
refer to 3-04.
- Final gear oil
 - Checking
 - 1) Loosen oil check bolt

Note: Do not remove the bolt, otherwise the gear oil may come out.

- 2) Check that gear oil seeps out or not. If no oil seeps out, change the final gear oil.

- Changing
 1. Remove oil filler bolt & drain plug and drain out final gear oil (place a container under the final gear case).
 2. Install back the plug and fill oil to final gear case

Periodic oil change: 290cc

Oil change after disassembling: 330cc

Recommended oil: SAE 90 API "GL-4"

Hypoid gear oil.

- 3) Replace a new gasket and install back the bolt.

- Differential gear oil
 - Checking
 - 1) Remove the oil filler bolt
 - 2) Check oil level which should be up to the brim of hole. If oil level low, add oil to proper level.
 - Changing
 - 1) Remove the oil filler bolt & drain plug and drain out the oil (place a container under the final gear case).

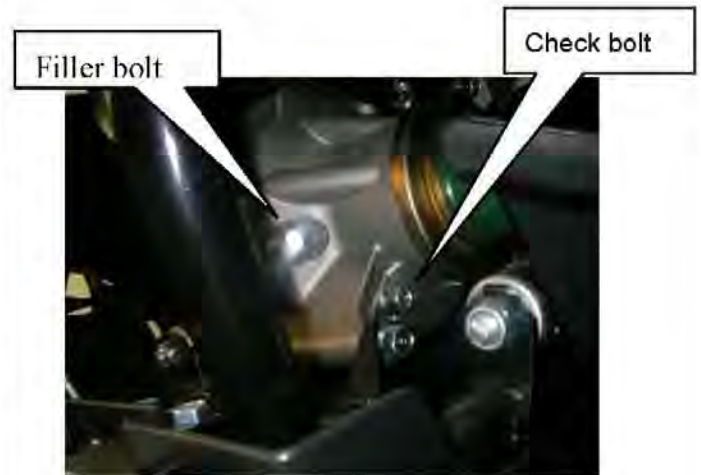

- 2) Install back oil filler bolt and fill oil to differential gear case.

Periodic oil change: 290cc

Oil change after disassembling: 330cc

Recommended oil: SAE 90 API "GL-4"

Hypoid gear oil.

- 3) Replace a new gasket and install back the filler bolt.

2-20. Toe-In adjustment

Place the machine on a level surface.

Measurement:

- 1) Ensure both front tire tread centers.
- 2) Let handlebar straight ahead
- 3) Measure the width A between the marks
- 4) Rotate the front tires 180° until the marks are exactly opposite one another.
- 5) Measure the width B between the marks.
- 6) Calculate the toe-in by

$$\text{Toe-in} = B - A$$

Toe-in : 0 ~ 10mm (with tire touching the ground)

- 7) If toe-in incorrect, adjust it
 - Mark both tie-rods ends.
 - Loosen the locknuts(tie-rod end) ① of both tie-rods.
 - The same number of turns should be given to both the right and left tie-rods ② until the specified toe-in is obtained. This is to keep the length toe-in of the rods the same.
 - Tighten the rod end locknuts of both tie rods, check the A = B roughly.

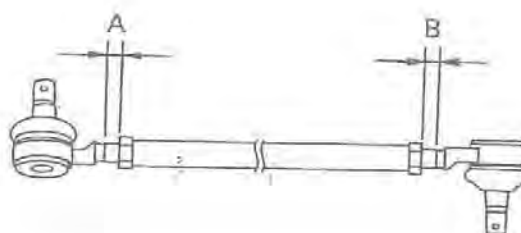
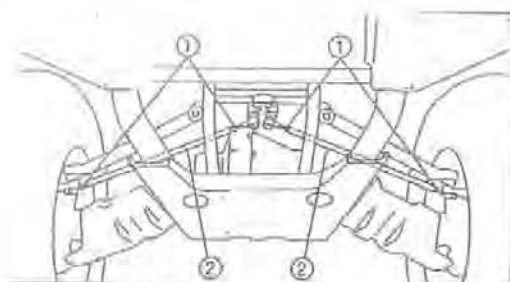
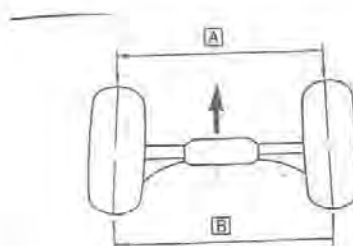

2-21. C.V. Joint Boot Check

Often to check the C.V joint boot (front and rear),

Damage → Replace (refer to Chapter 17)



2-22. Seat Opening & Installing

- Opening – Stop the engine and turn the key to the left to engage cable and release seat catch.
 - cable should be adjusted to be proper
- Installing – Put seat forward down to the two catches of chassis and hook the catch and insert to the dampers.
 - ensure a damper in the middle, missing → replace.



2-23. Nuts, Bolts Tightness

Perform periodical maintenance in accord with the Periodical Maintenance Schedule. Check if all bolts and nuts on the frame are tightened securely.

Check all fixing pins, snap rings, hose clamp, and wire holders for security.

2-24. ECM(EFI system)

Please keep clean and order in lines on the ECM position.

The ECM is equipped with a self-diagnostic function. If this function detects a malfunction in the system, a fault code is stored in the memory of the ECM. The fault code can be read only by OBD (On –Board Diagnosis) provided by SMC.

Refer to 19-04/19-05.



2-25. Fuel pump (EFI system)

It have been installed with fuel tank. Please check the fuel pump function every maintenance. Refer to 19-08.



2-26. Injector (EFI system)

It's very accurate parts.

- Avoid dropping. Dropping => replaced
- Leaking => replaced
- shortage => replaced
- blocked => clean by supersonic machine in a specified solvent
- less to pull/insert the connector as possible as you can
- refer to 19-06.





Note:

- 3-01. Mechanism Diagram
- 3-02. Precautions in Operation
- 3-03. Troubleshooting
- 3-04. Engine Oil
- 3-05. Oil Filter Unit
- 3-06. Engine Oil Pressure Checking
- 3-07. Oil Pump
- 3-08. Oil Delivery Pipe
- 3-09. Oil catch

3-01. Mechanism Diagram

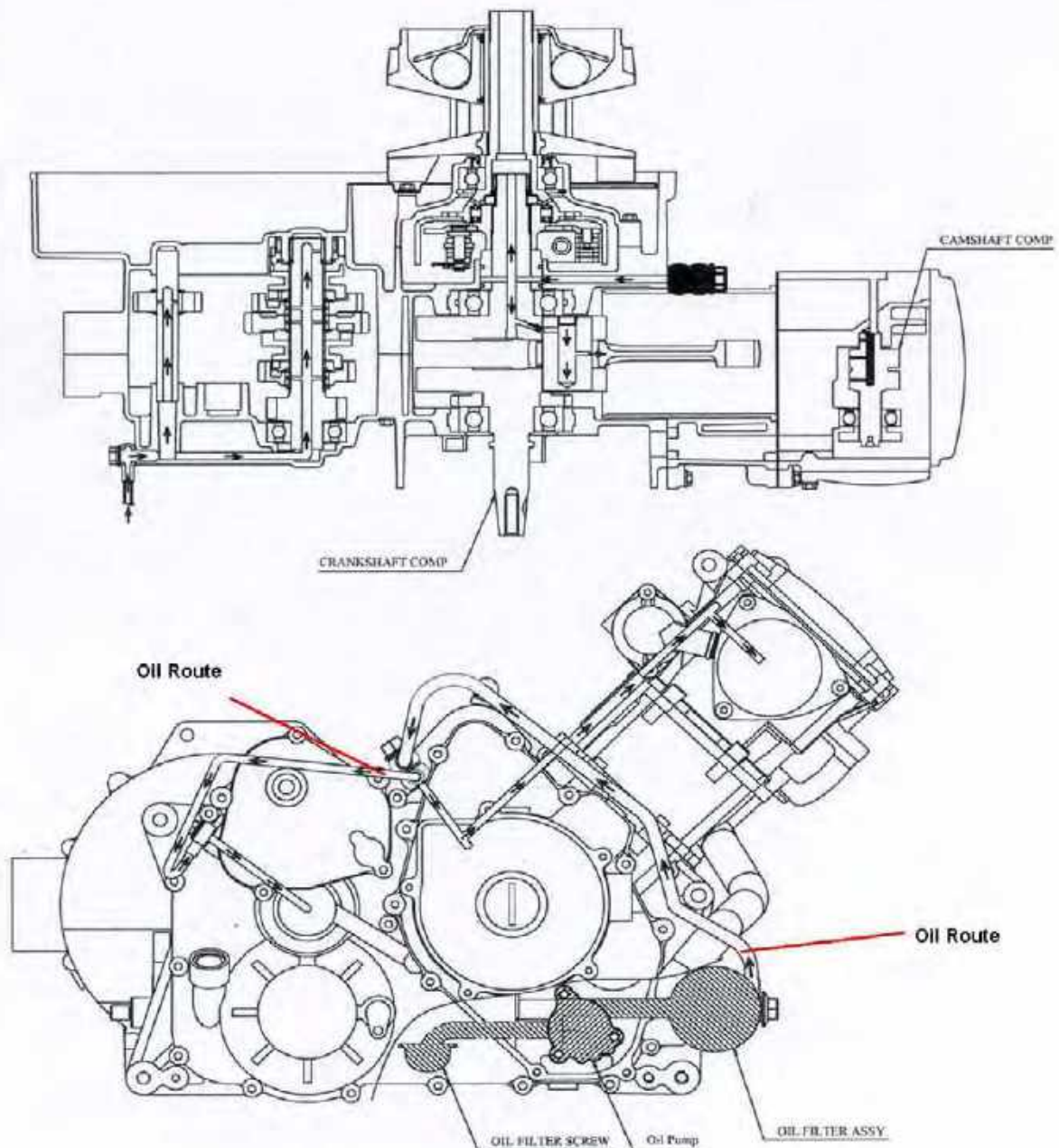

3-02. Precautions in Operation

General Information

This chapter contains maintenance operation for the engine oil pump and gear oil replacement.

Specifications

Engine oil capacity Disassembly: 2500 c.c.
 Replacement: 2200 c.c.

Replacement with oil filter replaced: 2300 c.c.

Oil viscosity SAE 10W-40 MA class
 (Recommended: Synthetic base)

Rear axle gear oil replacement: 290c.c.

Front differential gear oil replacement: 290c.c.

Gear oil viscosity SAE 90W

Torque value

Oil strainer cap 1.0~1.4kgf-m
 Engine oil drain bolt 1.8~2.2kgf-m
 Gear oil drain bolt 1.0~1.4kgf-m

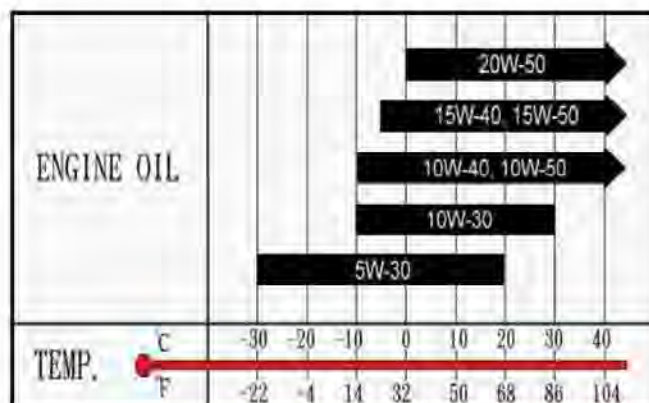

3-03. Troubleshooting

Low engine oil level

- Oil leaking
- Valve guide or seat worn out
- Piston ring worn out
- Abnormal blow-by

Low oil pressure

- Low engine oil level
- Clogged in strainer, circuits or pipes
- Oil pump damage

Dirty oil

- No oil change in periodical
- Cylinder head gasket damage
- Piston ring worn out
- Inferior oil quality
- Overheating

3-04.Engine Oil

Oil Check

Turn off engine, and park the ATV in flat surface.
Check oil level with oil dipstick.

1. Screw out the dipstick, wipe out the oil on the dipstick
2. Plug the dipstick into engine, slightly screw dipstick, and take out for oil level checking.

If oil level is nearly to low level, fill recommended oil to be in the between upper and lower level.

Oil Change

Caution

Drain oil as engine warmed up so that makes sure oil can be drained smoothly and completely.

- 1) Place the machine in flat level.
- 2) Start the engine and let it warm up for several minutes.
- 3) Stop the engine and place an oil pan under the ATV, and remove dipstick and oil drain bolt.
- 4) Drain out the engine oil from crankcase.
- 5) Replace a new washer and install back oil drain bolt.
- 6) Fill sufficient oil to reach the specified level and screw back dipstick.
- 7) Warm-up the engine for a few minutes, then stop the engine .
- 8) Check again the oil level in the range of levels or not.

Torque value : 2.0kgf-m

Recommended oil: refer to 3-02.



3-05. Oil Filter Unit

Remove the oil filter unit with special tool.

Special Service Tool: OIL FILTER WRENCH

- 1) Same steps to drain out the engine oil as 3-04.
- 2) Remove the oil filter unit by oil filter wrench.
- 3) Apply few engine oil to lubricant the surface of O-ring on the new oil filter unit. Make sure that the O-ring is properly seated on oil filter unit.
- 4) Tighten the new oil filter unit to specified torque with oil filter wrench.
- 5) Same steps to fill engine oil as 3-04.

Torque value : 1.8~2.0kgf-m

Special Service Tool: Oil filter Wrench

Caution:

- Genuine parts should be replaced only. Please use SMC genuine oil filter unit.
- To get the best protection to the engine, strongly suggest to replace the oil filter unit all the time when engine oil replacement.

Oil Quantity:

Periodic oil change : 2.2L

With oil filter replacement: 2.3L

Disassembly: 2.5L

Please follow recommended oil chart(3-02).

3-06. Engine Oil Pressure Checking

Always check the engine pressure after replacing the engine oil.

- Slightly loosen the oil gallery bolt on the cylinder head.
- Start the engine to seep from the oil gallery



bolt. If no engine oil comes out after one minute turn engine off so that it will not seize.

- Check the engine oil passages, oil filter unit and oil pump for damage or leakage.
- After solving the findings, start the engine again and check it again.
- Tighten the oil gallery bolt.

3-07.Oil Pump

A. Oil Pump Removal

- a. Remove the AC Generator.(Refer to Chapter 9).
- b. Remove the cir-clip on the oil pump driven sprocket.
- c. Remove out the nut on oil pump drive sprocket.
- d. Remove out the oil pump chain and sprockets.
- e. Screw out the 3 screws on the oil pump.
- f. Remove the oil pump.
- g. Make sure that pump shaft can be rotated freely.



B. Oil Pump Disassembly

- a. Remove the screw on oil pump cover and remove the cover.
- b. Remove oil pump shaft, inner rotor, outer rotor and cover.

C. Oil Pump Inspection

Check the clearance between oil pump body and outer rotor.

Limit: 0.15 mm

Check clearance between inner and outer rotors.

Limit: 0.12 mm

Check clearance between rotor side face and pump body

Limit: 0.12 mm

Out of any specification → replace the oil pump.

D. Oil Pump Re-assembly

1. Install the inner and outer rotors into the pump body.
2. Align the indent on driving shaft with that of inner rotor.
3. Install the oil pump shaft and roller.
4. Install the oil pump cover and fixing pins properly.
5. Tighten the oil pump screw.

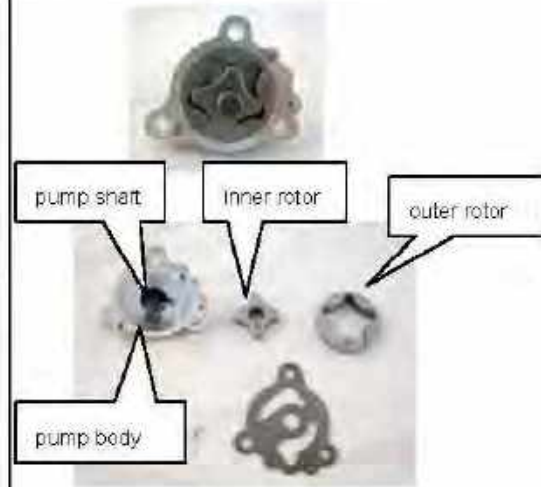

E. Oil Pump Installation

1. Install the oil pump gasket
 - always install the new one.



2. Install the oil pump, and then tighten screws.

Torque value : 1.0kgf-m



3. Make sure that oil pump shaft can be rotated freely.

4. Install the oil pump driving and driven sprocket, and then install cir clip onto oil pump shaft, nut to the driving sprocket.



5. Use "-" type screw driver and hammer to stake the skirt of the nut, lock the nut.



3-08.Oil Delivery Pipe

Always check to the two delivery pipes condition / connecting concerning to the oil replacement.

A. Removal two delivery pipes

- 1) screw out the three union bolts by sequence a, b, c as shown.
- 2) remove the two delivery pipes and all bolts and washers.



B. Inspect

- 1) delivery pipes
 - bent/crash/damage → replace
 - contact face roughness → replace
- 2) union bolts/washers
 - damage/block/crash/roughness → replace
 - cooper washer always replace the new one.

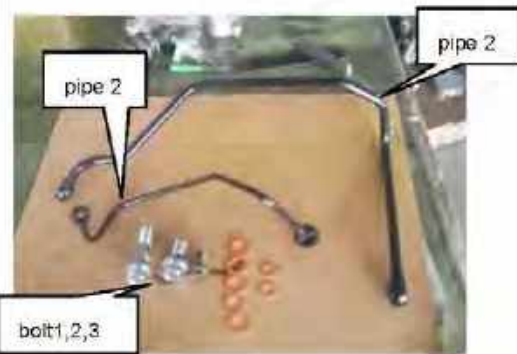

C. Install oil delivery pipe

Sequence steps as below:

- 1) Screw union bolt 1 through delivery pipe 1 & pipe 2 and three washers as shown into crankcase L by hand. Ensure the pipe 1 to be under pipe 2.
- 2) Screw union bolt 2 and washers through into crankcase R by hand.
- 3) Screw union bolt 3 and washers through into crankcase R by hand.
- 4) Ensure two delivery pipes to be fitted in a freely.
- 5) tighten the union bolt 1 , 2 then 3 in sequence.
- 6) Fix the two clamps in freely to the covers as shown.

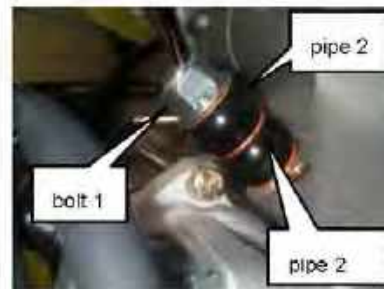

Torque value:

Bolt 1 & 2 : 2.5 kgf-m

Bolt 3 : 2 kgf-m

3-09.Oil catch

The way to oil catch function as followings:

- 1)Oil divided by catch ass'y from gear box cover.
- 2)Divided oil go back to engine through crankcase R.
- 3) Divided gas go into air cleaner.





Replaced filter in every maintenance.
Clean filter if deterioration.

Notes:

5-01. Precautions in Operation.....

5-02. Removal of Engine.....

5-03. Engine Installation.....

5-04. Exhausted-pipe.....

5-01. Precautions in Operation

General Information

- The engine has to be supported with special service tools that can be lifted or adjustable.
- The following parts can be serviced as engine being mounted on frame:
 - Carburetor
 - Start motor.

Specification

Item		Capacity
Engine oil capacity	Replacement	2200 c.c.
	Oil and oil filter change	2300 c.c.
	Disassembly	2500 c.c.
Rear axle gear oil capacity	Replacement	290 c.c.
Front differential gear oil capacity	Replacement	290 c.c.
Coolant capacity	Engine& radiator	2080 c.c.
	Reservoir	300+/- 20 c.c.
	Total	2380 c.c.

5-02. Engine Removal

a. Remove the seat.

- Switch the ignition switch from "off" to "seat open" to release the seat.
- Remove out the seat.

b. Remove the battery

- Remove the battery cord.
Firstly remove negative terminal (-) and then remove the battery positive (+) terminal.
- Remove the battery.

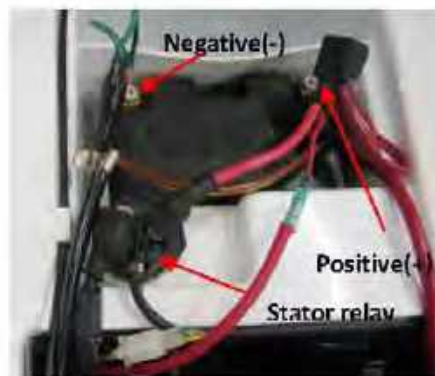

c. Remove the R & L side cover above the footrest cover.

- Screw out the 7 tapping screws at side covers
- Remove out the R and L side cover.



d. Remove R & L footrest cover

- Screw out 8 pan head screws in connecting to R/L footrest bar and front/rear cover.
- Remove the R and L footrest cover



e. Remove the front carrier

- Remove out 4 flange bolts from front carrier.
- Remove out the front carrier

f. Remove out the front top cover.

- Screw out 4 tapping screws as photo show.
- Remove out the front too cover.

g. Remove the Multi-functional display

- Screw out 1 fixing bolt
- Disconnect the meter wire coupler from wire harness.
- Remove the multi-functional display.

h. Remove the top cover (fuel tank cover)

- Remove the fuel tank cap
- Remove out two tapping screws at the front of top cover (fuel tank cover) in connecting with front cover.
- Remove the screw on the gear shifter ball grip, and then remove the gear shifter ball grip
- Turn and remove the ignition switch cap
- Remove the 2 flange bolts at rear side above the fuel tank (co-tighten structure with fuel tank & top cover to the frame)
- Remove the top cover (fuel tank cover).



i. Remove the fuel tank.

- Switch off the fuel cock to OFF
- Disconnect the fuel unit wire connector
- Disconnect the fuel hose between fuel cock and carburetor.
- Remove the fuel tank.

(for detail message, please refer to 4-06)

j. Remove the front cover.

- Remove 7 tapping screws on the front cover in connecting with front shield cover.
- Remove out the front cover.

k. remove out the rear carrier

- Remove the 4 flange bolts in connecting between rear carrier and frame behind the rear cover
- Remove out the rear carrier.

l. remove the rear fender.

- Remove tapping screws inside the rear storage box
- Remove the pan head screw M6x15 (96318-06015-G)*3 and tapping screw (96112-51216-K) *10 on the rear cover side in connecting with frame and rear baggage cover.
- Remove the 2 flange bolts, then remove the seat catch stay, disconnect the seat lock cable.
- Disconnect the electrical connectors for tail



light, wipers.

- Remove the rear fender.



m. Remove the muffler

- Loose the clamp at connecting side between exhaust pipe and muffler.
- Remove the two flange bolts on the muffler side to engine.
- Remove the flange bolt on the rear muffler
- Remove the muffler from front exhaust pipe.



n. Remove the exhaust pipe

- In EFI system, disconnect oxygen sensor firstly.
- Remove 2 flange nuts on the front cylinder head side
- Pull the front exhaust pipe out from cylinder head and then remove it.



Caution: Oxygen sensor unit can't be dropped and tortured.



o. Disconnect the CVT cooling inlet & outlet duct.

- Remove the clamps on CVT outlet duct at rear side of L. Crankcase, and disconnect the air duct.
- Remove the clamps on CVT inlet duct joint between CVT inlet duct and LH crankcase, then remove air inlet duct and air inlet joint.



cooling outlet duct

cooling inlet duct

p. Remove the carburetor (or throttle body)

- remove 3 screws and remove the throttle cable on the throttle controller box on carburetor (or throttle body)
- remove the choke cable from carburetor (only)
- remove the 2 clamps on the air cleaner breather tube and intake pipe.
- Remove the carburetor (throttle body)



(refer to 4-04 for detail)

q. Remove electrical wire couplers from engine

- Remove the spark plug cap
- Remove the A.C. Generator wire couplers and release out from frame clamps.
- Disconnect the gear position sensor coupler
- Disconnect the velocity sensor coupler.
- Disconnect the Thermo sensor plug coupler.
- Disconnect the start motor coupler & Ground wire.
- In EFI, there are more couplers have to be disconnected ex. Injector, TPS, IACV,CTS...etc. (refer to Chapter 19)



r. remove the gear shifter and gear shifting limiter, brake switch bracket from engine.

- Screw out the flange bolt from shift lever, and remove out gear shifting rod.
- Screw out 2 bolts to remove out shift lever limiter.
- Screw out the bolt to remove the brake switch bracket from engine side..



s. Remove out the liquid cooling pipes from engine

- Disconnect 2 water pump coolant hose clamps on inlet and outlet side of water pump
- Drain out all coolant at the time disconnecting In hose, water pump
- Disconnect the two coolant hose clamps from cylinder head and cylinder side.

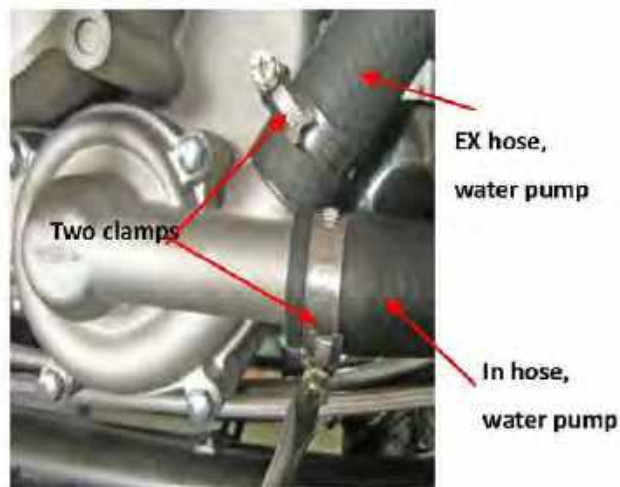

Caution:

- Use container to reverse the coolant.
- Check the hose crash => replaced

t. remove the front and rear drive shaft connector.

- Remove 4 socket bolts on the front universal joint at front gear box side, and remove the front drive shaft.
- Remove 4 socket bolts on the universal joint in connecting with engine output shaft side and then remove the rear propeller shaft.

Caution: Be careful not to do any damage to the rubber boot.



u. engine remove out

- Loosen the front and rear side engine rubber damper mounting locknuts.
- Screw out 2 flange bolts on each side of the engine rubber dampers at front & rear engine hanger side.
- Remove out the engine by left side.



5-03. Engine Installation

Check the engine rubber dampers for any damage.

Install the engine in the reverse procedures of removal.

Caution

- Be careful when removing and installing the engine.
- Do not crash the body covers when removal and installing.
- Follow the recommended torque values for all installing engine and covers.
- Follow the recommended loctite glue applying when installing.
- Replace all necessary consuming parts.
- Do not bend or twist the wires and tubes.
- Cables wires have to be routed in accordance with normal layout.
- Follow the necessary instructions to install back water pump.

1) Always replace new o-rings

2) smell lubricant roundly and slightly insert the water pump ass'y

3) install back the bolts by crisscross fixing

Torque value:

Flange bolt M6*40 & M6*70: 1.0kgf-m

- Ensure refill recommended lubricant and sufficient quantity.
- To avoid foreign dropping to CVT cover, to cover the opening of CVT inley and outlet ducts when you assemble parts.

Torque value: Engine hanger (cushion block)

- a. Flange bolt M10*20:5.5kgf-m
- b. Flange bolt M6*20: 1.0kgf-m
- c. Flange Nut M10: 5.5kgf-m



5-04. Exhausted-pipe

a. Removal

refer to 5-02.n

b. Inspection

- Identify the exhausted-pipe version

- Check front pipe and rear muffler crack → replaced
- Check protection cover and insulated fiber crack/damage → replaced

- Check spark arrester/tail-pipe crack/blocked → replaced / clean (refer to 2-15)

c. Installation

refer to 5-02.n

Caution:

- Two nuts fixing to cylinder head have to be fixed averagely.

- Always replace new gasket at once disassembling.



NOTE:

6-01. Mechanism Diagram
6-02. Precautions in Operation
6-03. Troubleshooting
6-04. Cylinder Head Removal
6-05. Cylinder Head Inspection
6-06. Valve Seat Inspection and Service
6-07. Cylinder Head Reassembly
6-08. Intake & pipe

6-01. Mechanism Diagram

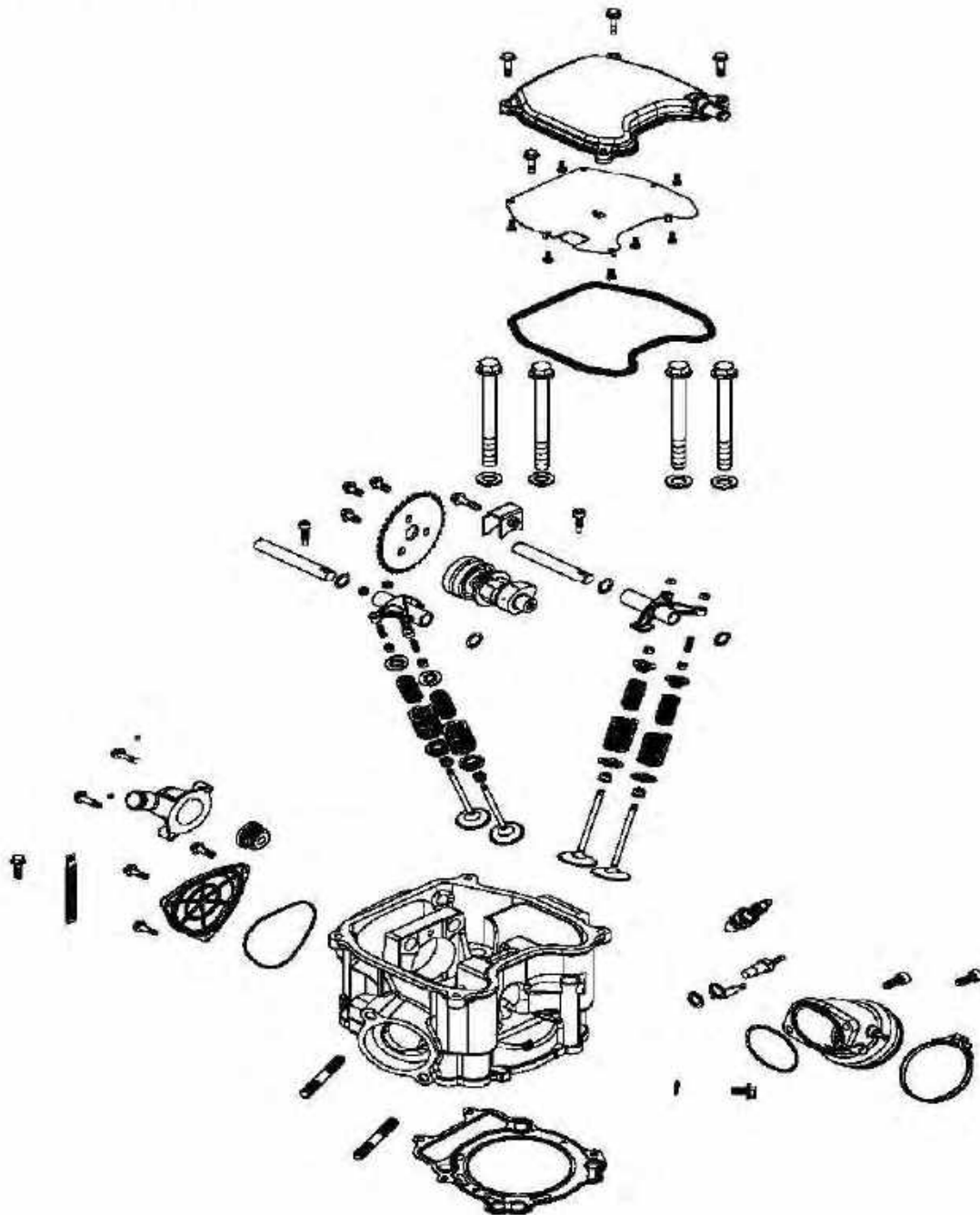

6-02. Precautions in Operation

General Information

- This chapter is contained maintenance and service for cylinder head, valve, and camshaft as well as rocker arm.
- Cylinder head service can be carried out when engine is in frame.

Tools

Special service tools

Valve reamer: 5.0mm

Valve guide driver: 5.0mm

Valve spring compressor

6-03. Troubleshooting

Engine performance will be affected by troubles on engine top parts. The trouble usually can be determined or by performing cylinder compression test and judging the abnormal noise generated.

Low compression pressure

1. Valve

- Improper valve adjustment
- Burnt or bent valve
- Improper valve timing
- Valve spring damage
- Valve carbon deposit
- Valve worn out

2. Cylinder head

- Cylinder head gasket leaking or damage
- Tilt or crack cylinder

3. Piston

- Piston ring worn out.

High compression pressure

- Too much carbon deposit on combustion chamber or piston head

Noise

- Improper valve clearance adjustment
- Burnt valve or damaged valve spring
- Camshaft wear out or damage
- Chain wear out or looseness
- Auto-tensioner wear out or damage
- Camshaft sprocket
- Rocker arm or rocker arm shaft wear out

6-04. Cylinder Head Removal

a. Remove the engine from the frame.
(Refer to chapter 5)

b. Remove the thermostat

- Remove 2 thermostat bolts and open the thermostat cover.
- Remove the thermostat.

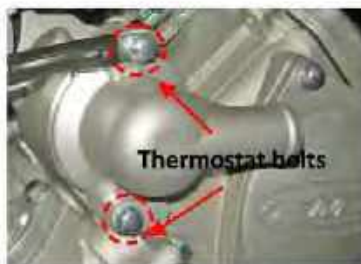

c. Remove the cam chain tensioner

- Remove the 2 flange bolts
- Remove the cam chain tensioner.



d. Remove the spark plug.



e. Remove 4 bolts from the head cover then remove cylinder head cover.



f. Remove the Cylinder head side cover.

- Remove the 3 side cover mounting bolts of cylinder head.
- Then remove the side cover of cylinder head.

g. Piston TDC position align

- Remove tappet adjusting cap on right crankcase cover, and turn the crank shaft.
- Align the timing mark on the cam sprocket with that of cylinder head to make the piston at TDC position.

h. Remove the Cam Sprocket

- Remove 3 bolts from the cam sprocket.
- Remove the cam sprocket.



Cam sprocket disk

i. Cylinder Head remove

- Remove the 2 bolts cylinder head mounting bolts from cylinder head right side,
- Then remove 4 bolts and 4 washers from cylinder head upper side.
- Remove the cylinder head.

Caution:

Different cylinder head on EFI system
(refer to 19-12).

j. Remove cylinder head gasket and 2 dowel pins.



k. Remove cam chain guide.

l. Clean up residues from the matching surfaces of cylinder and cylinder head.



Caution

- Do not damage the matching surfaces of cylinder and cylinder head.
- Avoid residues of gasket or foreign materials falling into crankcase as cleaning.

m. Remove the rock arm and camshaft

- Screw out the bolt on the stop plate of rock ram shaft and remove the stop plate
- Screw out the 2 fixing bolts of rock arm shaft



- Remove out the rock arm shaft and rock arm.



- Remove the camshaft



o. Remove the valve, cotter, valve spring and seal

- Use a valve cotter remove & assembly tool to press the valve spring, and then remove valves.

Caution

In order to avoid loose of spring elasticity, do not press the spring too much. Thus, press lengths is based on the valve cotter in which can be removed.

- Remove valve stem seals.
- Clean carbon deposits in combustion chamber.
- Clean residues and foreign materials on cylinder head matching surface.

Caution

Do not damage the matching surface of cylinder head.



6-05. Parts inspection

a. Cylinder Head Inspection

- Check if spark plug and valve holes are cracked.
- Eliminate carbon deposits by a rounded scraper then clean it in solvent.
 - avoid damaging valve seats/guide, plug threads and matching surface.
- Eliminate mineral deposits/rust on water jacket.
- Measure cylinder head warp with a straightedge and thickness gauge on cross surfaces..

Service limit: 0.05 mm

b. Camshaft

- Inspect cam two lobes height for crash or out of specification → replace.

Service Limit:

IN: Replacement when less than 39.173mm

EX: Replacement when less than 39.008mm

- Inspect the camshaft bearing for looseness or wear out. → replace the whole set.
- Inspect the key wearing and spring damage → replace the whole set.

c. Rocker Arm

- Measure the rocker arm I.D., and wear or damage, oil hole clogged? → replace.
- Lobe blue discoloration or scratches → replace

Service Limit: Replace when it is more than 13.034 mm

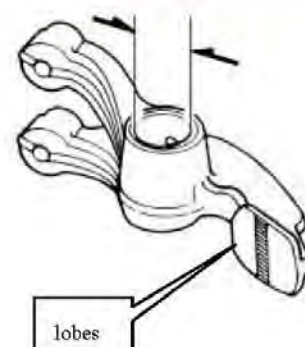
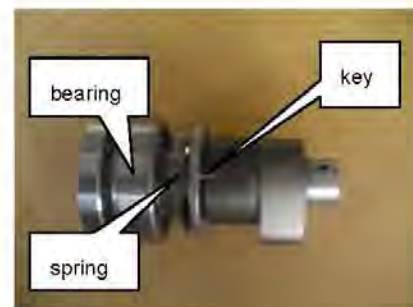

d. Rocker Arm Shaft

Measure the active O.D. of the cam rocker arm shaft and cam rocker arm.

Service Limit: Replace when it is less than 12.973 mm.

Calculate the clearance between the rocker arm shaft and the rocker arm.

Service Limit: Replace when it is less than 0.06mm.

e. Valve spring free length

Measure the free length of intake and exhaust valve springs.

Service limit:

Inner spring 37.70 mm

Outer spring 37.30 mm

f. Valve stem

- Check if valve stems are bend, crack or burn.
- Check the operation condition of valve stem in valve guide, and measure & record the valve stem outer diameter.
- Runout measurement if out of specification → replace.

Service Limit:

IN: 4.945 mm

EX: 4.925 mm

Runout limit: 0.01mm

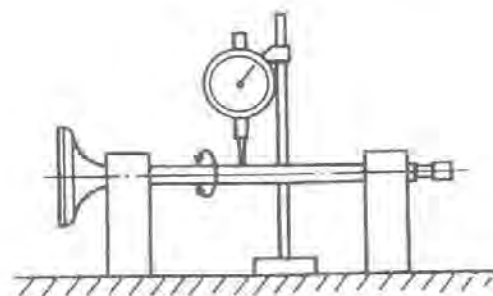
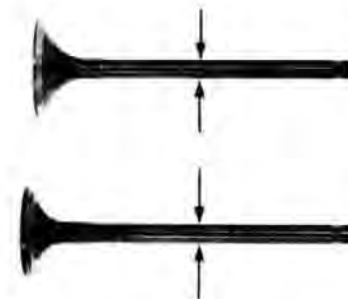
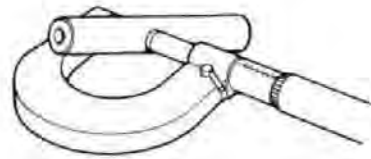

302.0

g. Valve guide

Caution

Before measuring the valve guide, clean carbon deposits with reamer.

Tool: 5.0 mm valve guide reamer

Measure and record each valve guide inner diameters.

Service limit: 5.05 mm

The difference that the inner diameter of valve guide deducts the outer diameter of valve stem is the clearance between the valve stem and valve guide.

Service Limit: IN < 0.08 mm

EX < 0.10 mm

Note:

- When installing a new valve always replace the guide.
- If the valve is removed or replaced always replace the valve oil seal

6-06. Valve Seat/Valve Inspection

and Service

Clean up all carbon deposits on inlet and exhaust valves. Apply with emery slightly onto valve contact face. Grind valve seat with a rubber hose or other manual grinding tool.

Caution

Do not let emery enter into between valve stem and valve guide.

5.0mm valve guide reamer

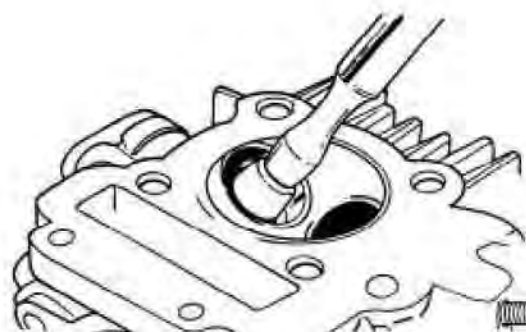

Clean up the emery after corrected, and apply with engine oil onto contact faces of valve and valve seat. Remove the valve and check its contact face.

Caution

Replace the valve with a new one if valve is roughness, wear out, or incomplete contacted with valve seat.

Valve seat inspection

If the valve seat is too width, narrow or rough → replace

Valve seat wide

Service limit: 1.6mm

Check the contact condition of valve seat.

Valve seat grinding

The worn valve seat has to be ground with valve seat chamfer cutter.

Refer to operation manual of the valve seat chamfer cutter.

Use 45° valve seat chamfer cutter to cut any rough or uneven surface from valve seat.

Caution

- After valve guide had been replaced, it has to be ground with 45° valve seat chamfer cutter to correct its seat face.
- Use 32° cutter to cut a quarter upper parts out.
- Use 60° cutter to cut a quarter lower parts out.

Remove the cutter and check new valve seat.

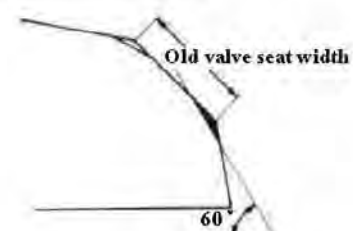
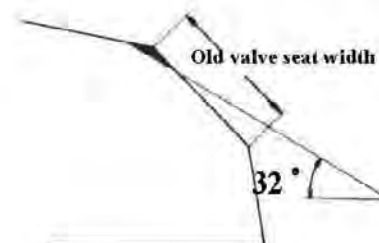
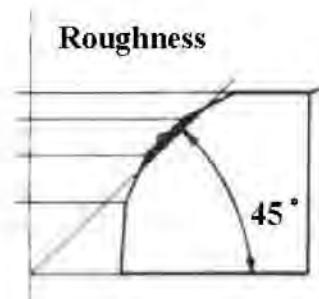
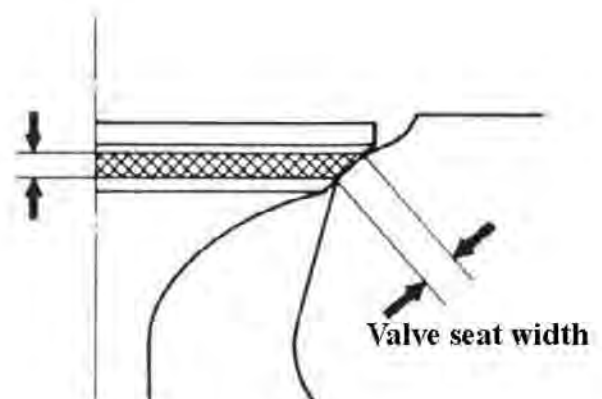

Use 45° cutter to grind the valve seat to specified width (1.0mm).

Caution

- Make sure that all roughness and uneven faces had been grounded.
- Grind valve seat again if necessary.
- Coat the valve seat surface with red paint.
- Install the valve through valve guide until the valve contacting with valve seat, slightly press down the valve but do not rotate it so that a seal track will be created on contact surface. Then check the contact surface.

Caution

The contact surfaces of valve and valve seat are very important to the valve sealing capacity.

- If the contact surface too high, grind the valve seat with 32° cutter. Then, grind the valve seat to specified width. If the contact surface too low, grind the valve seat with 60° cutter. Then, grind the valve seat to specified width.
- After the valve seat ground, coat valve seat surface with emery and then slightly press the ground surface.
- Clean up all emery coated onto cylinder and valve after ground.
- Install back all components properly & spark plug and test any leaking by filling little fuel to combustion space.

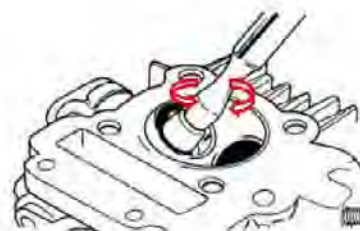
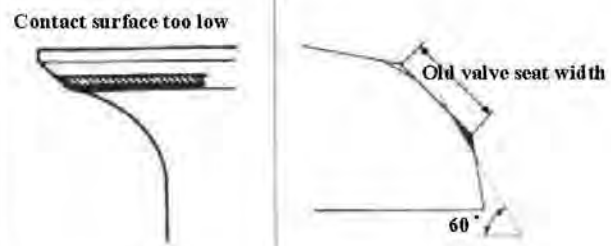
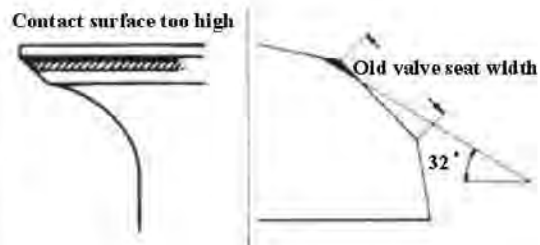
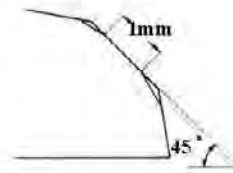

6-07. Cylinder Head Reassembly

a. install the valve

- Lubricate valve stem with engine oil, and then
- Insert the valve into valve guide.
- Install new valve stem oil seal.
- Install valve springs and retainers.

Caution

The closed coils of valve spring should face down to combustion chamber.

Use a valve cotter remove & assembly tool to press the valve spring, and then remove valves.

Caution

To avoid damaging the valve stem and the cylinder head, in the combustion chamber place a rag between the valve spring remover/installer as compressing the valve spring directly.

Special Service Tool:

Valve cotter remove & assembly tool

Tap the valve stems gently with a plastic hammer to make sure valve retainer and valve cotter is settled.

Caution

- Place and hold cylinder head on to working table so is can prevent from valve damaged.

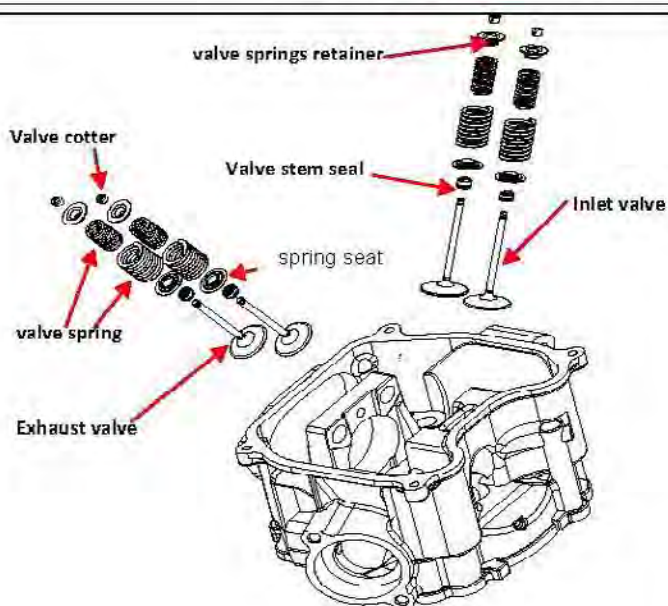

b. Install the camshaft and rocker arm

- Apply engine oil to the bearing of camshaft.
- Insert the camshaft to the cylinder head. Be careful to push slightly to avoid the damage.



- Insert the Rocker arm shaft, the rocker arm and plate washer between rocker arm, adjust the ditch of rocker arm shaft to the vertical



- Tighten the bolt for rocker arm shaft.



- Install the fixing plate of rocker arm.



c. install the cylinder head onto the cylinder.

- Clean up all residues and foreign materials from the matching surfaces of both cylinder and cylinder head.
- Install chain guide, dowel pins and a new cylinder head gasket onto the cylinder.

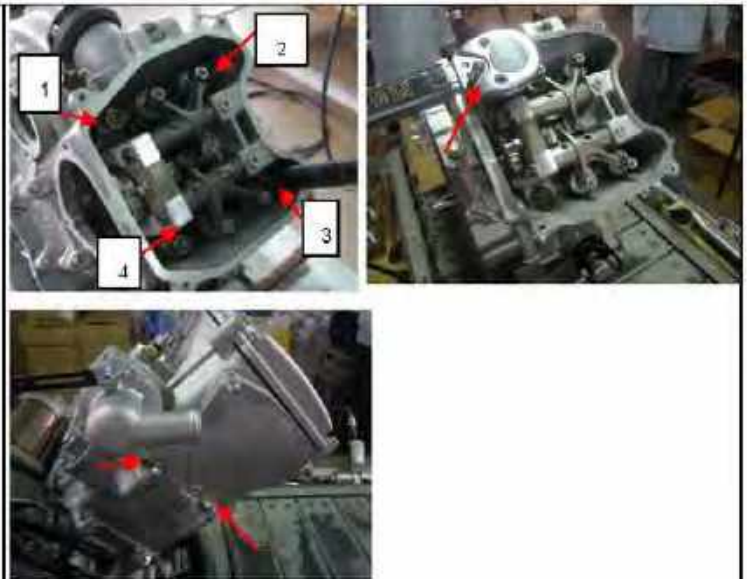

Caution

1. Do not damage the matching surfaces of cylinder and cylinder head.
 2. Avoid residues of gasket or foreign materials falling into crankcase as cleaning.
- Install 4 washers and bolts to cylinder head. Tighten the bolts to the specified torque in three steps (4=>5=>6kgf-m) in the proper tightening sequence as shown. Then tighten 2 cylinder head mounting bolts of cylinder head right side.



Torque value:

Cylinder head bolt : 6.0kgf-m

Cylinder mounting bolt : 1.0~1.4kgf-m

d. Install the Cam chain sprocket and timing align.

- Open A.C.G. Cap on the R. Crankcase side, double check if the T mark available (make sure crankshaft/piston at TDC position.). if not, adjust it by crank the crankshaft at A.C.G. side for adjusting.
- Align the camshaft 3 fixing holes upright and 1 fixing hole at bottom.
- Install cam chain to sprocket and align:
"I" mark on the sprocket align to "." on the cylinder head.
- Tighten the sprocket mounting bolts

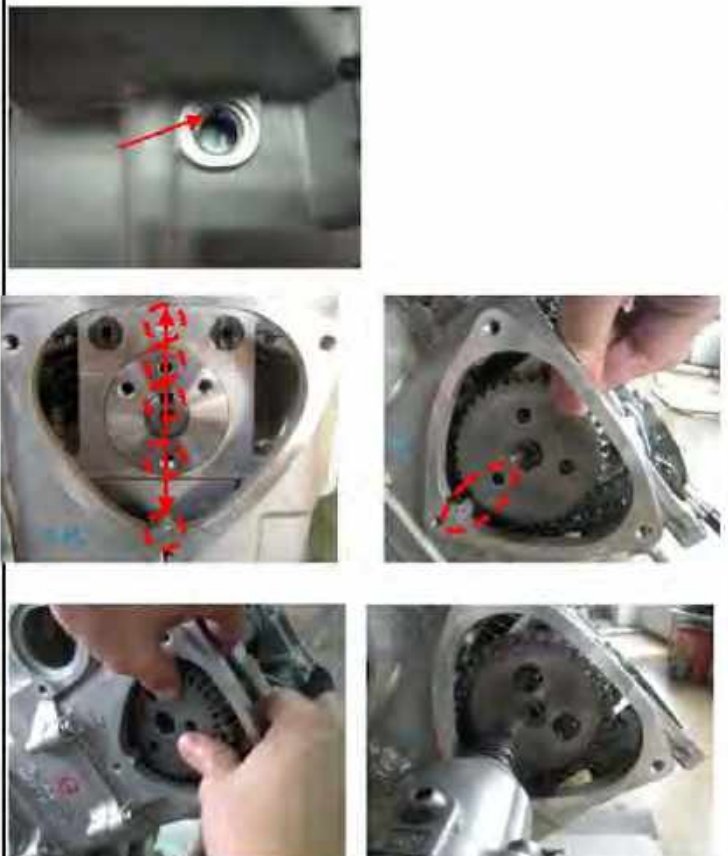

Caution

Make sure timing marks are matched.

e. Install the cylinder head side cover (3 bolts).

f. Install the cam chain tensioner

- Loosen auto tensioner adjustment bolt and remove bolt and spring.
 - checking : push the convex and test teeth bar smoothly.
 - check the spring
- Install tensioner with gasket and install spring and adjustment bolt with oil ring.

g. Install the thermostat and thermostat cover (2 bolts).
Caution

Make sure the hole is also being matched to the upper indent on cylinder head.

h. Valve Clearance Adjustment

- Loosen valve clearance adjustment nuts and bolts located on valve rocker arm.
- Measure and adjust valve clearance with feeler gauge.
- After valve clearance had been adjusted to standard value, hold adjustment bolt and then tighten the Adjustment nut (refer to 2-07).

Standard Value:
 IN 0.10 ± 0.02 mm
 EX 0.15 ± 0.02 mm

- Check the adjusting bolt contact surface any damage or blue discoloration → replace
- Smell sufficient oil to all combinations in the cylinder head.

i. Install the cylinder head cover

- check any damage on gasket
- insert gasket to the groove of head cover properly and install back bolts.
- ensure the matching perfectly after installing.



j. Install and tighten spark plug (NGK CR7E)

Torque value: 1.1~1.3kgf-m

Caution

- This model is equipped with more precision 4-valve mechanism so its tighten torque cannot be exceeded standard value in order to avoid causing cylinder head deformation, engine noise and leaking so that vehicle performance be affected.
- refer to 2-06

k. Install the engine onto frame (refer chapter 5).

6-08. Intake & pipe

a. Removal

1. Release the clamp
2. Remove the connecting pipe
3. Unscrew the M6*20 bolt x 2
4. Remove the intake

b. Inspection

1. Aluminum intake base crack /crack /deteriorated => replace/clean
2. connecting pipe crack/aged/torture => replaced

c. Installation

Do the reverse steps of removal.

Caution:

- Convex of connecting have to be correctly installed to concave of aluminum intake.
- Screw up clamp in a proper toque avoid damaging connecting pipe.



- The other end of connecting pipe to the carburetor or throttle body (EFI system) shall be screwed up in an certain range and torque (with a certain collar).



- Intake of EFI system with injector base shall keep it as clean as possible (refer to 19-06)



injector

NOTE:

7-01. Mechanism Diagram
7-02. Precautions in Operation
7-03. Trouble Shooting
7-04. Cylinder and Piston Removal
7-05. Inspection on Cylinder /Piston/Piston Ring
7-06. Piston Ring Installation
7-07. Piston Installation
7-08. Cylinder Installation

7-01. Mechanism Diagram

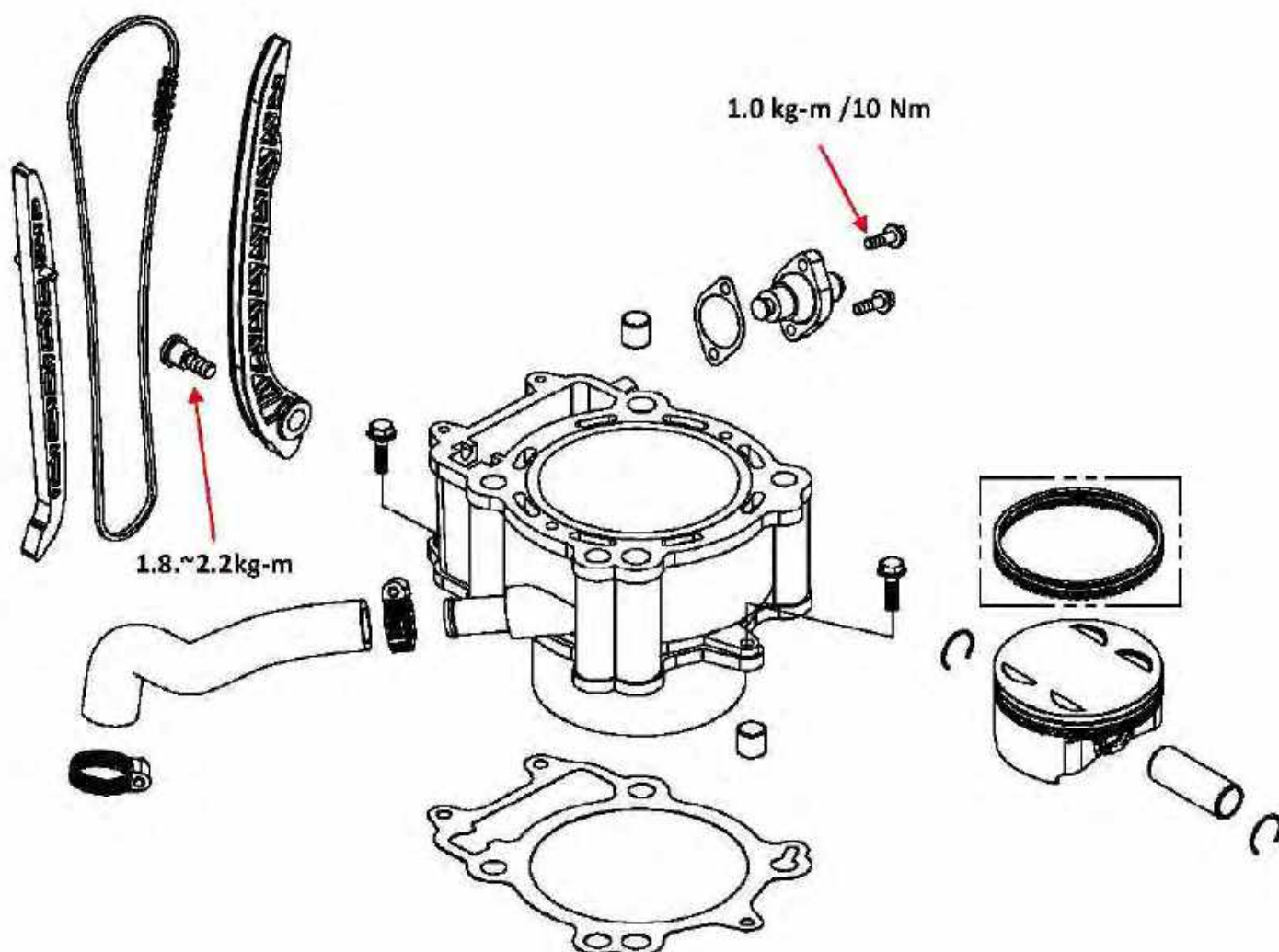

7-02. Precautions in Operation

General Information

Both cylinder and piston service cannot be carried out when engine mounted on frame.

Specification

Unit : mm

Item		Limit	
Cylinder	ID	100.1	
	Bend	0.05	
Piston / Piston ring	Clearance between piston rings	Top ring	0.13
		2 nd ring	0.13
	Ring-end gap	Top ring	0.70
		2 nd ring	0.80
		Oil ring side rail	-
	Clearance between piston and cylinder		0.15
ID of piston pin boss		23.045	
OD of piston pin		22.971	
Clearance between piston and pin		0.074	

7-03. Trouble Shooting

Low or Unstable Compression Pressure

- Cylinder or piston ring worn out

Smoking in Exhaust Pipe

- Piston or piston ring worn out
- Piston ring installation improperly
- Cylinder or piston damage
- Abnormal blow-by

Knock or Noise

- Cylinder or piston ring worn out
- Carbon deposits on cylinder head top-side
- Piston pin hole and piston pin worn out

Engine Overheat

- Carbon deposits on cylinder head top-side
- Cooling pipe clogged or not enough in coolant flow

7-04. Cylinder and Piston Removal

- a. Remove the cylinder head (refer to chapter 6).
- b. release the hose clamps and then remove the Water pump EX hose from cylinder.
- c. Screw out the 3 flange bolts (M6*25) on cylinder outer side.



d. Remove the cylinder.

Pull out the cylinder slowly, especially when bottom of the cylinder wall close to piston/piston ring

Caution:

Cover the hole of crankcase and cam chain with a piece of cloth or plate stopper to prevent foreign material falling into the crankcase.



e. remove the piston/pin/clip from crankshaft

- Remove the piston pin clips.
- Remove the piston pin and piston from connecting rod.



f. Remove the cylinder gasket and dowel pins.

g. Ceramic cylinder have been released.

7-05. Inspection on Cylinder /Piston

/Ring

a. Cylinder wall check

Check if the inner diameter of cylinder is worn out or damaged.



In the 3 positions, top, center and bottom, of cylinder, measure the X and Y values respective in the cylinder.

Service limit: **100.1 mm**

b. Check cylinder if warp.

Service limit: **0.05 mm**

c. Measure clearance between piston rings and grooves.

Service Limit: **Top ring: 0.13 mm**
2nd ring: 0.13 mm

d. Piston ring check

- Remove piston rings carefully.
- There are 3 rings (top ring/second ring/ oil ring x 1 set (3 pcs)).
- Check if the piston rings are damaged or its grooves are worn.

Caution

Pay attention to remove piston rings because they are fragile.

Ring end gap check:

- Place piston rings respective into cylinder below about 50 mm of cylinder top (push the ring with piston crown to be at a right

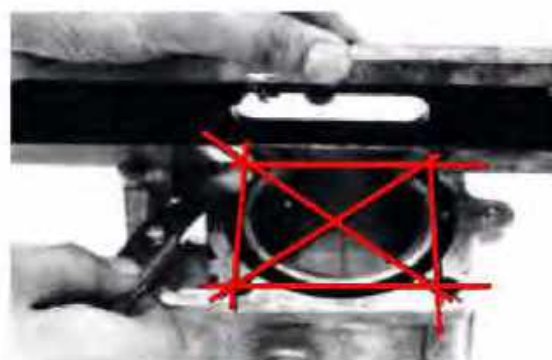
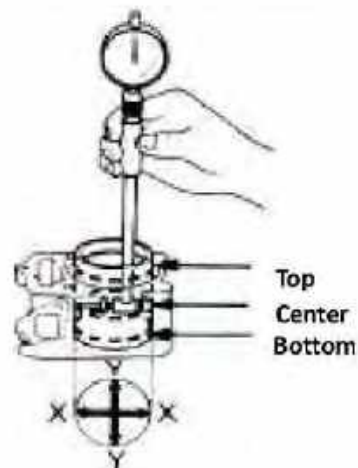

angle on the cylinder bore) then measure ring end gap by feeler gauge.

- Top ring with chrome coating is different from 2nd ring.

Service Limit: Top ring: 0.70 mm

2nd ring: 0.80 mm

Note: You can't measure the end gap on the expander spacer of the oil ring. If oil ring rails show excessive gap → replace all rings.

e. Measure the outer diameter of piston pin.

Service Limit: 22.971 mm

f. Measure the inner diameter of piston pin hole.

Service Limit: 23.045 mm

g. Calculate clearance between piston pin and its hole.

Service Limit: 0.74 mm

h. Measure piston skirt diameter.

Measure piston out-skirt "D". The measurement position is **5.0 mm** from piston bottom edge by micrometer.

Standard skirt diameter:

99.945 ~ 99.995mm

Out of specification → replace

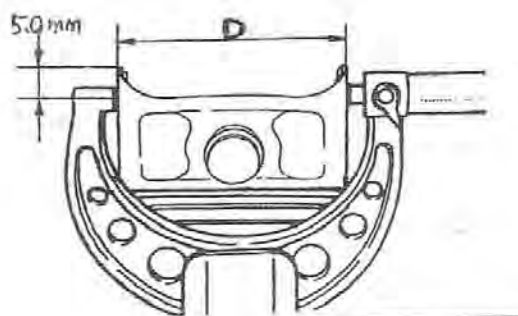

i. Measure cylinder bore diameter

Measure the average value "R" at 50mm from the top of cylinder by cylinder bore gauge.

$$R = (X+Y)/2$$

Standard cylinder bore diameter:

100.005 ~ 100.055mm

Service limit : 100.1mm

Out of specification → rebore or replace

j. Calculate clearance between piston and cylinder

- refer to step i & j.
- value $R - D =$ piston-to-cylinder clearance

Service limit : 0.15mm

Out of specification → rebore or replace cylinder , and replace the piston and piston rings as a set.

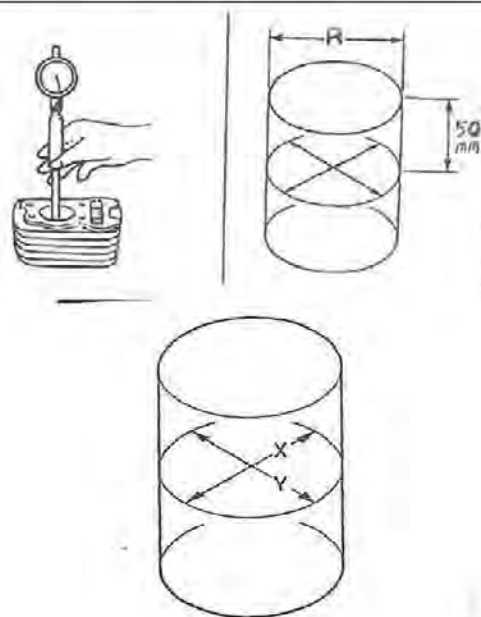

7-06. Piston Ring Installation

Clean up piston top, ring groove, and piston surface.

Install the piston ring onto piston carefully.

Place the openings of piston ring as diagram shown.

Caution

- Do not damage piston and piston rings in installation.
- All marks (RN) on the piston rings must be forwarded to up side.
- Top ring with chrome coating is different to 2nd ring.
- Make sure that all piston rings can be rotated freely after installed.

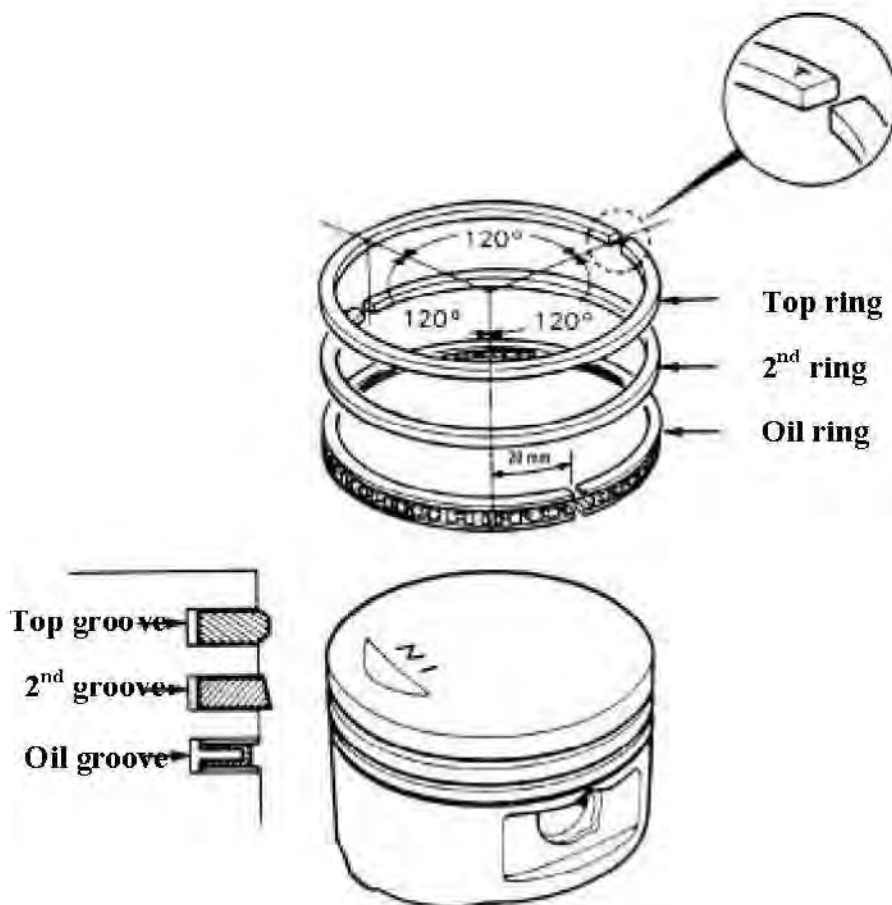

7-07. Piston set Installation

- Before installation of Piston set onto connecting rod, clean up all residues and foreign materials on the contact surface of crankcase. Pay attention not to let these residues and foreign materials fall into crankcase.

Caution

Wet the residues into solvent so that the residues can be removed more easily.

- Install piston and piston pin by placing the IN marks on the piston topside forward to inlet valve.
- Install 2 new piston pin clips, avoid the clip end gap gap too near to cut out groove of piston.

Caution

1. Do not let the opening of piston pin clip align with the piston cut out.
2. Place a piece of cloth or stopper tool between piston and crankcase in order to prevent snap clip from falling into crankcase as during servicing.
3. Match the same grade with piston and cylinder in a new installation.

7-08. Cylinder Installation

- Install dowel pins and new cylinder gasket.

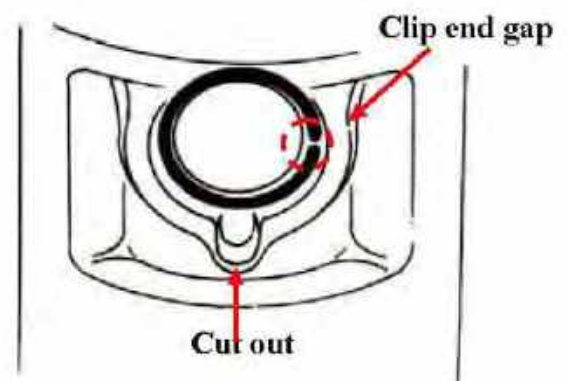

- Apply some engine oil to inside of cylinder, piston and piston rings.
- Use piston clamber to hold the piston ring and install the cylinder parallel and gentle to avoid damage the cylinder inner wall. When the piston rings are all installed inside cylinder, remove the clamp and push gently to install cylinder to crankcase.

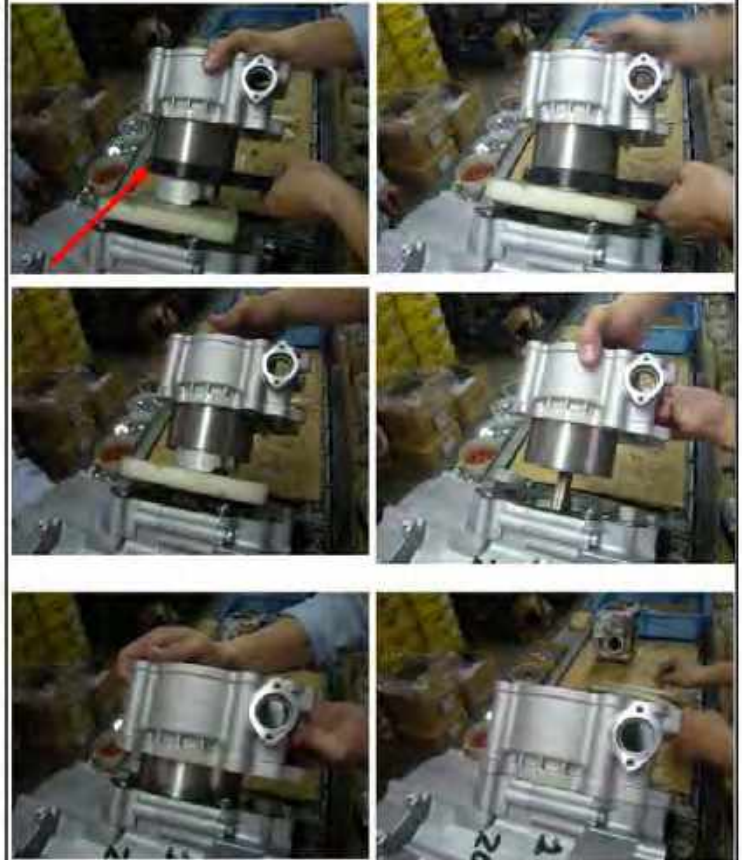

Caution

- Do not push piston into cylinder forcefully because piston and piston rings will be damaged.
- Be careful not to damage the timing chain damper during installation.
- Pass the timing chain through the timing chain cavity and hold the chain until installing cylinder head.

- Tighten the cylinder to crankcase by 3 flange bolt

Torque: Cylinder Flange Bolt (M6x25):

1.0kg-m /10Nm

- Install coolant hose with hose clamp onto cylinder and water pump side.
- Install cylinder head (refer to Chapter 6).



NOTE:

- 8-01. Mechanism
- 8-02. Maintenance Description
- 8-03. Trouble Diagnosis
- 8-04. Left Crankcase Cover
- 8-05. Primary Sheave , Driven Sheave & Drive Belt
- 8-06. Clutch Housing, One Way Clutch and Clutch Carrier

8-01. Mechanism Diagram

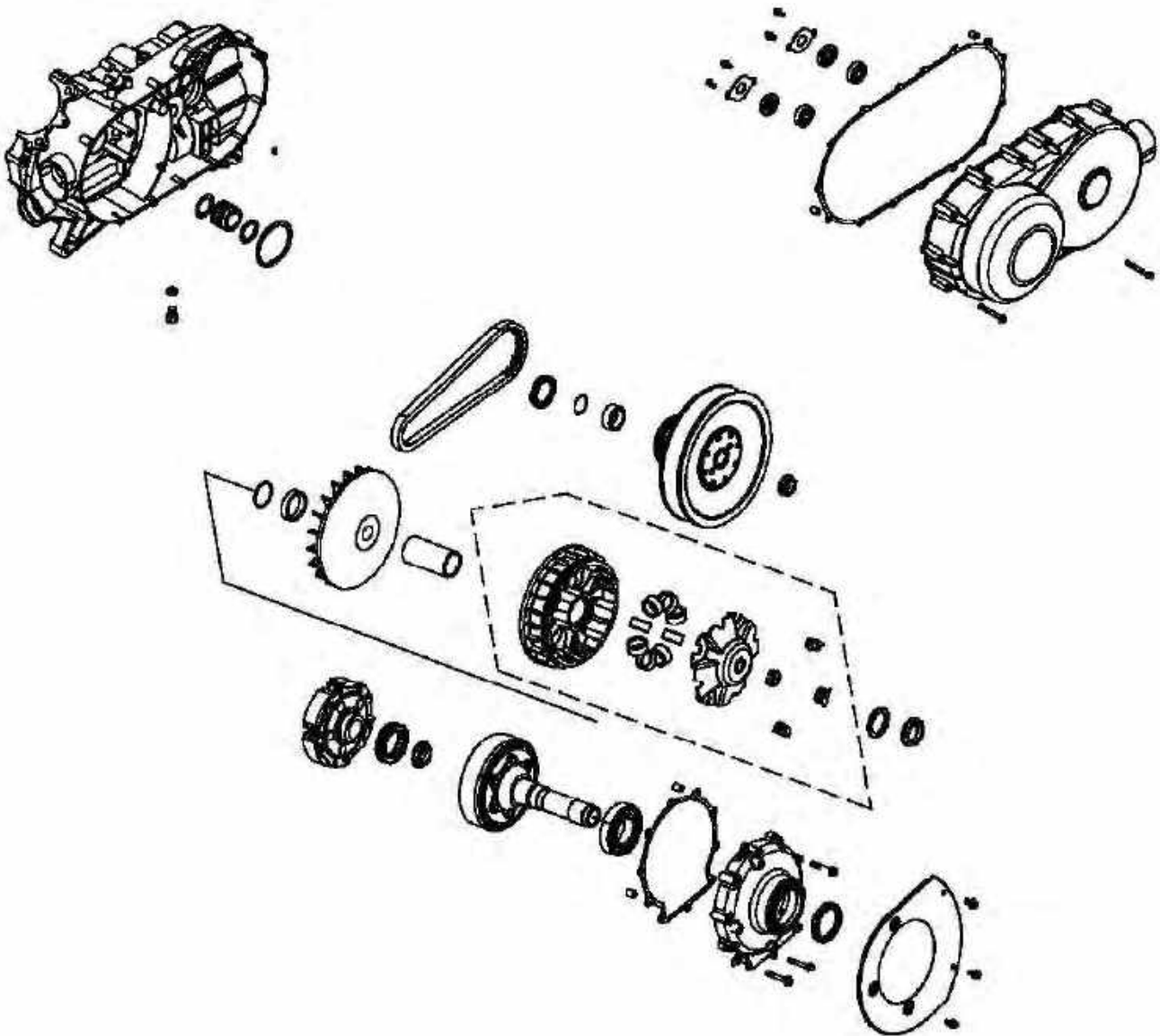

8-02. Maintenance Description

Precautions in Operation

General Information

- Drive face, clutch outer, and driven pulley can be serviced on the vehicle.
- Drive belt and drive pulley must be free of any grease.

8-03. Trouble Diagnosis

Engine can be started but ATV can not be moved

1. Worn drive Belt / Slipping belt
2. Worn drive face
3. Worn or damaged clutch weight
4. Broken driven pulley
5. Damage clutch spring
6. Damage transmission gear

Shudder or misfire when driving

1. Broken clutch weight
2. Worn clutch weight

Insufficient horsepower or poor high speed performance

1. Worn drive belt / Oil or grease on V-belt
2. Insufficient spring force of driven pulley
3. Worn roller
4. Driven pulley operation un-smoothly
5. Clutch nut not fixed firmly
6. Worn pin groove or pin
7. Worn, bent clutch shoe
8. Faulty operation

Clutch slips

1. Damaged, loose or worn clutch spring
2. Damaged or worn clutch shoe
3. Seized primary sliding sheave

8-04. Left Crankcase Cover

a. Left crankcase cover removal

1. Release the rear air duct clamps and disconnect the CVT rear air duct from left crankcase. (if engine is not removed).
2. Remove left crankcase cover flange bolts M6*55 (15bolts).
3. Remove 2 dowel pin from L. Crankcase and L. Crankcase gasket.
4. Remove the flange bolt M6*12 inside the L. Crankcase cover, and open the bearing cover plate.
5. Remove out the oil seal, and then inside ball bearings (if broken only).

b. Inspection

1. Check the oil seal if cracks or damage. Replace with new if necessary.
2. Rotate the two ball bearings inside the L. crankcase cover, check if it can be rotate smoothly and solid. If not, replace with new bearings by bearing remove and install tools.

c. Left crankcase cover installation

1. Add some grease to the oil seal and ball bearings
2. Install the front and rear bearing cover plate and tighten by flange bolt M6*12.

Torque: flange bolt M6*12: 1.0kg-m / 10Nm

3. Insert the 4 dowel pins
4. Put on the L. crankcase cover and insert the 15 flange bolt (M6*55)



5. Tighten the flange bolt by steps of cross direction

Torque: Flange bolt M6*55.
1.0kg-m /10Nm.

8-05. Primary Sheave , Driven Sheave & Drive Belt, CVT cooling fan plate.

8-05-01 Removal

1. Hold the primary sheave ass'y by holder (special tool), and loosen & remove the nut on the Primary Sheave Assy (or Movable driving face Ass'y).
2. Pull out the primary sheave ass'y, and remove the drive belt (refer to 2-11).
3. Remove the lock nut on the driven sheave, and pull out the driven sheave ass'y. Then remove the slide collar, o-ring and oil seal from primary drive gear.
4. Remove the primary fixed sheave, slide collar out from clutch housing comp.
5. Loose the 5 flange bolt M6*12 and then remove the CVT cooling fan plate.

8-05-02. Inspection

a. Drive Belt Inspection



1. Check the drive belt for crack or wear.
Replace it if necessary.
2. Measure the width of drive belt as diagram shown.
3. Refer to 2-11.

Service Limit: 28.3 mm

Replace the belt if exceeds the service limit.

Caution

- Using the genuine parts for replacement.
- The surfaces of drive belt or pulley must be free of grease.
- Clean up all grease or dirt before installation.

b. Primary sheave Ass'y Inspection

1. Weight Roller (8 pcs)

- Check the rollers worn out or damaged.
→ Replace them.
- Measure each roller's outer diameter.
Out of specification → Replace them.

Service limit: 29.50 mm

2. Primary Sheave Comp, Fixed Sheave, Pully Cam & Slide spacer

- Check the sliding surface of Primary sheave comp, Fixed sheave, Pully cam if exceeds worn out, cracks or damage.
- Check the oil seal on the primary sheave.
- Check the slide spacer if exceeds wear out or damage.

3. Slide Piece (4 pcs / set)

Check the slide piece if distort, crash or damaged. Replace with new set if damage.

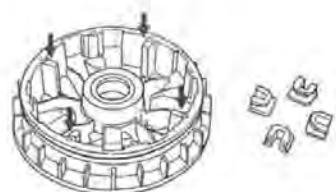
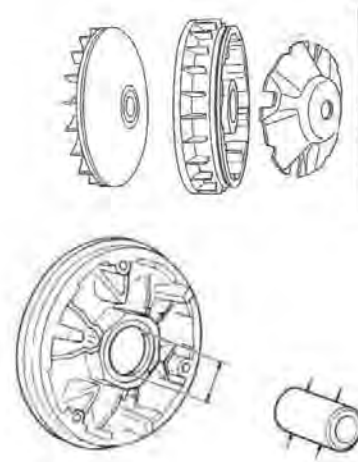

c. Driven Sheave Assy, Slide Collar, O-ring and Oil seal.

1. Driven Sheave Assy

Check following items:

- Operation smooth on cam groove and guide pin.
- If both sheave surfaces are scratch or damage.
- If guide pin groove is damaged or worn.
→ Replace with new Driven Sheave Ass'y.
- if the spring out of specification → replace **service limit**: 121mm (free length: 124.3mm)

2. Driven sheave bearing Inspection

- Check if the inner bearing oil seal is damage. Replace it if necessary.
- Check if needle bearing is damage or too big clearance. Replace it if necessary.
- Rotate the inside of inner bearing with fingers to check if the bearing rotation is in smooth and silent.

Note:

- Do not suggest to dispatch the Driven Sheave ass'y without vise, special tools and helps. Compression spring bounding is dangerous.
- Apply enough grease to groove, seal, o-rings when install back and fix the nut in 9kgf-m.

3. Slide Collar / O-Ring / Oil Seal

Check slide collar, O-ring, Oil seal if damage or worn out. Replace with new if damaged.

8-05-03. Installation

1. Insert the Oil seal, slide collar to the primary drive gear and use installing tool to install the oil seal & slide collar.
2. Install the cooling fan plate by tighten 5 flange bolt M6x12mm.

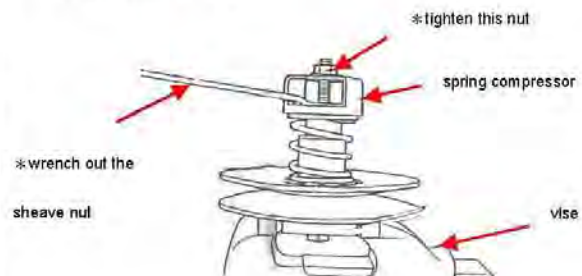
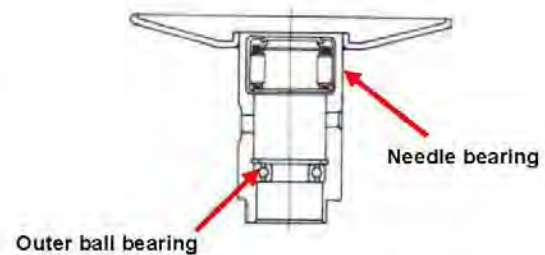
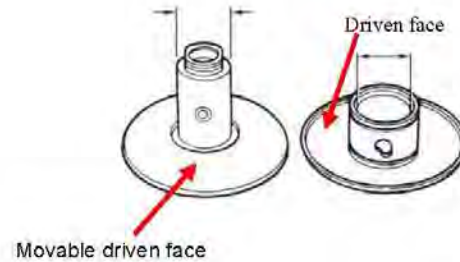
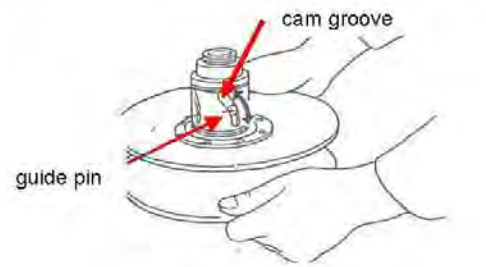

Torque: flange bolt M6x12mm: 1.0kg-m /10Nm

3. Insert the O-ring to the primary drive gear.
4. Put on the primary fix sheave, driven sheave ass'y and driving belt. Expand the driven sheave gap for driving belt to hold at inner sheave surface (refer to 2-11).
5. Tighten the nut M20 with little loctite glue on the driven sheave ass'y.



Torque value : 12kgf-m

6. Put the Primary sheave ass'y onto the clutch housing. Insert the plate washer and screw in the plate nut.
7. Hold the primary sheave by primary sheave holder , and then tighten the lock nut with loctite glue by specific torque.



Torque value: 18kgf-m

8-06 Clutch Housing, One-Way Clutch Bearing and Clutch Carrier.

Caution:

Drain out the engine oil before the clutch service.

a. Removal

1. Loosen each bolt 1/4 of a turn in crisscross pattern working. Remove them after all of them are loosened.

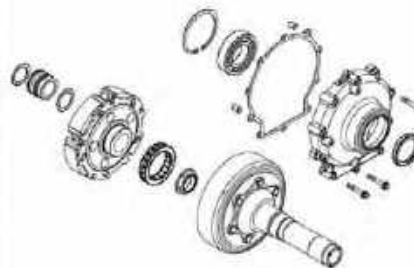

2. Pull the clutch housing shaft to remove the clutch cover, clutch housing and one way clutch (it might be inside clutch housing).
3. Take out the clutch cover gasket, 2 dowel pin
4. Use clutch holder tool to hold the clutch carrier ass'y, then wrench out the nut on the clutch carrier.
5. Remove the clutch carrier
6. Remove the clutch carrier collar with ring x 2.



b. Inspection

1. Clutch carrier ass'y
 - heat damage → replace
 - wearing ==> measure shoe thickness out of specification → replace
 Service limit: 1.0mm
2. Clutch housing ass'y
 - contact surface heat damage → replace
 - contact surface crack/wearing → replace
3. One-way clutch bearing
 - chafing/wearing/damage → replace
 - one way function testing
 - a) Install the one-way clutch bearing and clutch carrier to the clutch housing ass'y

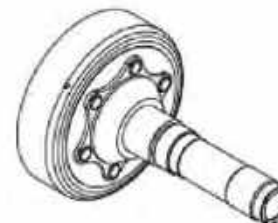
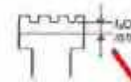

and hold the clutch carrier ass'y.

Note: The one-way clutch bearing should be installed with the flange side " → " facing toward the clutch carrier.

- b) When turning the clutch housing clockwise X, the clutch housing should turn freely. If not, replace the one-way clutch ass'y.
- c) When turning the clutch housing counter-clockwise Y, the clutch housing and crankshaft should be engaged. If not, replace the one-way clutch ass'y.

Note: Replace the one-way clutch ass'y (carrier + bearing) and clutch housing as a set.

4. Clutch cover ass'y

- Rotate the ball bearing on the clutch cover if smooth without abnormal noise/friction, replace with new if damage.
- Check the oil seal on the clutch cover if bad sealing or damage, replace with new if broken.

5. Clutch carrier collar with rings

- Collar clogged → clean
- Collar wearing/crack → replace
- Rings wearing/damage → replace
 - Ring installation to collar ==> buckle up two ends, if not → replace

Note: Ensure to install collar in a right direction to the engine

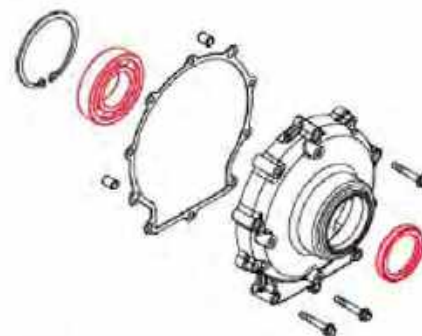

c. Installation

1. Install the two rings onto the clutch carrier collar, and then put onto the crankshaft.
2. Use tool to install the clutch carrier collar with rings. Ensure the right direction to the crankshaft.
3. Put on the clutch carrier assy onto the crankshaft and install the clutch carrier nut.
4. Use universal holder to hold the clutch carrier, use wrench to tighten the clutch carrier nut with specific torque.

Torque value: 25~26kgf-m

5. Use puncher and hammer to knock and lock the clutch carrier nut.

Note: Always replace a new carrier nut and secure it by puncher.

6. Put on the one-way clutch bearing.

Note: The one-way clutch bearing should be installed with the flange side " → " facing toward the clutch carrier.

7. Install the clutch housing with clutch cover/dowel pins/gasket and tighten the bolts in stages, using a crisscross pattern.

Note: After tightening the bolts, check the clutch housing ass'y to clockwise rotates smoothly.

Torque value (M6*40): 1~1.2kgf-m



Caution:

- Drain bolt have to be released in certain period to drain out water inside, specially after off-road duty.



NOTE:

9-01. Mechanism Diagram.....
 9-02. Precautions in Operation.....
 9-03. Right Crankcase Cover & A.C. Generator.....
 9-04. A.C.G Fly Wheel & One-Way Clutch.....
 9-05. Starter Clutch Gear & Starter Reduction Gear.....

9-01. Mechanism Diagram

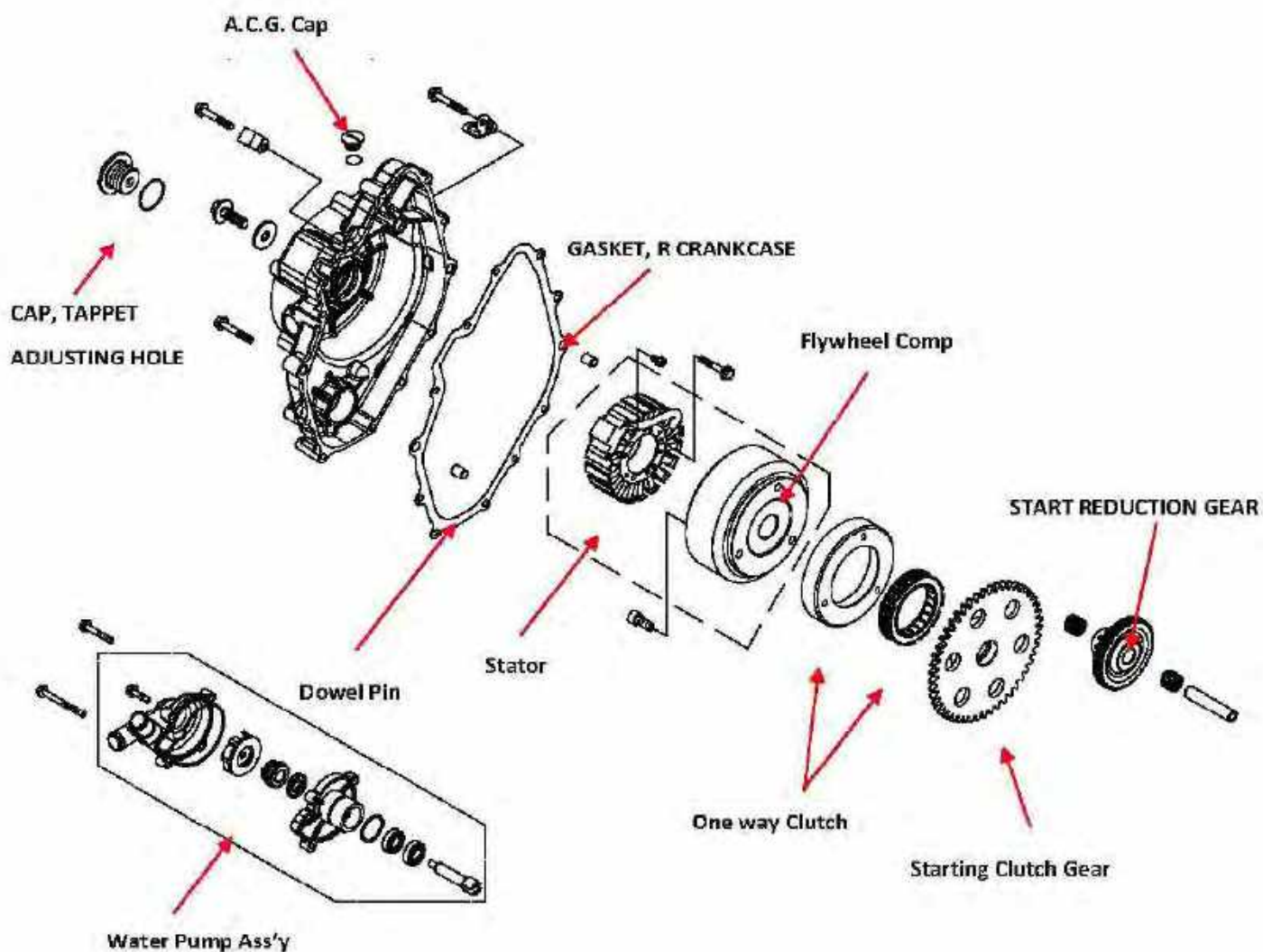

9-02. Precautions in Operation

General information

- Refer to chapter 18: The troubleshooting and inspection of alternator
- Refer to chapter 18: The service procedures and precaution items of starter motor

Tools

Special tools

A.C.G. flywheel puller

Universal holder

9-03. Right Crankcase Cover & A.C.

Generator

a. Removal

1. Drain the engine oil
2. Unscrew 12 mounted flange bolts from the right crankcase cover and then remove the right crankcase cover with A.C. Generator.

Note: Always working in a crisscross pattern, loosen each bolt 1/4 of a turn. Remove them after all of them are loosened.

b. Inspection

Check the Generator and Pulse coil if working normal (refer to chapter Electrical Equipment)

c. Installation

1. Install the A.C. Generator (Magneto Ass'y) to the right crankcase cover.
2. Install the dowel pins and R. Crankcase cover gasket to the R. Crankcase.
3. Put on the R. Crankcase cover (with Magneto) and tighten by 12 flange bolts in crisscross pattern.

Torque: Flange Bolt M6*40: 1.0kgf-m

9-04. A.C.G. Flywheel & One-Way

Clutch

a. Removal

1. Remove the flange bolt (or nut) and washer from A.C. Generator flywheel.

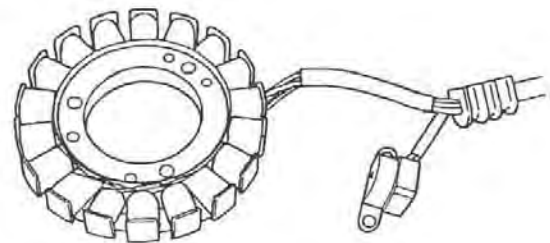

2. Use flywheel puller to remove flywheel.

- Screw in the flywheel flange bolt some threads by hand,
- Screw in flywheel puller clockwise to the crankshaft.

- Use wench to hold the A.C.G. flywheel puller and clockwise screw in the push shaft of A.C.G. flywheel puller,
- To pull out the A.C.G. Fly wheel ass'y with one way clutch.



3. EFI system (refer to 19-14)

- flywheel is with 23 sensor convex
- ensure CPS (crank position sensor) clearance at 1.1mm
- CPS send rpm message to ECM

b. Disassemble of One-way Clutch.

1. Remove 3 socket bolts from the inner side of A.C. G. flywheel.



2. Remove the clutch outer race and one way clutch from A.C.G. flywheel.



c. Outer Race & One-Way Clutch Inspection

1. Check outer race cracks/damage → replace
2. Check roller inside one-way clutch wear/damage → replace

3. One-Way Clutch Function test.

- Install the starting clutch driven gear onto one way clutch.
- Hold the flywheel and rotate starting clutch gear.
- The starting clutch gear should be rotated in C.C.W direction freely, but not C.W direction.

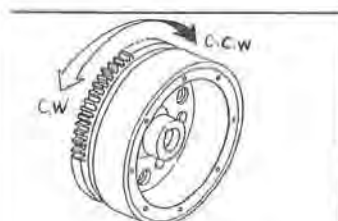
d. Installation (also in EFI system)

1. Put the one way clutch into clutch outer race and then install to A.C.G. Flywheel. Tighten the 3 socket bolts with glue.

Torque value: Socket boot M8*23: 3.3kgf-m

2. Align the flywheel groove with woodruff key, and then install the flywheel Ass'y (including one-way clutch) onto the R. Crankshaft.



3. Insert the plate washer and screw in the flange bolt (or nut). Tighten the flywheel flange bolt (or nut) by specific torque value.

**Torque: 8kgf-m for flange bolt
12kgf-m for nut**



9-05. Start clutch gear and Start Reduction Gear

a. Removal

1. Use the (-) Screw driver and hammer, to remove out the woodruff key and remove out the start clutch gear.
2. Remove out the Starting clutch driven gear and starting reduction gear, reduction gear shaft and 2 needle bearing.



b. Inspection

1. Starting clutch driven gear tooth
 - gear tooth - wear/damage → replace
 - inside contact hole - wear/damage → replace
 - outside contact surface - wear/pitting/damage → replace

2. Clutch reduction gear set tooth and shaft for wear or damage.
 - gear tooth - wear/damage/crack → replace
 - shaft - wear/damage/crack → replace
 - 2 pcs (set) needle bearings - damage/crack → replace



Clutch reduction gear set

3. Installation

1. Smell some oil and install the reduction gear shaft and reduction gear.

2. Insert the starting clutch gear of the flywheel

3. Insert the woodruff key onto right side of crankshaft

4. Keep continue to install the flywheel as mentioned chapter 9-04





NOTE:

10-01. Mechanism
10-02. Trouble Diagnosis
10-03. Gear box disassembly
10-04. Gear box Inspection
10-05. Gear box Reassembly

10-01. Mechanism Diagram

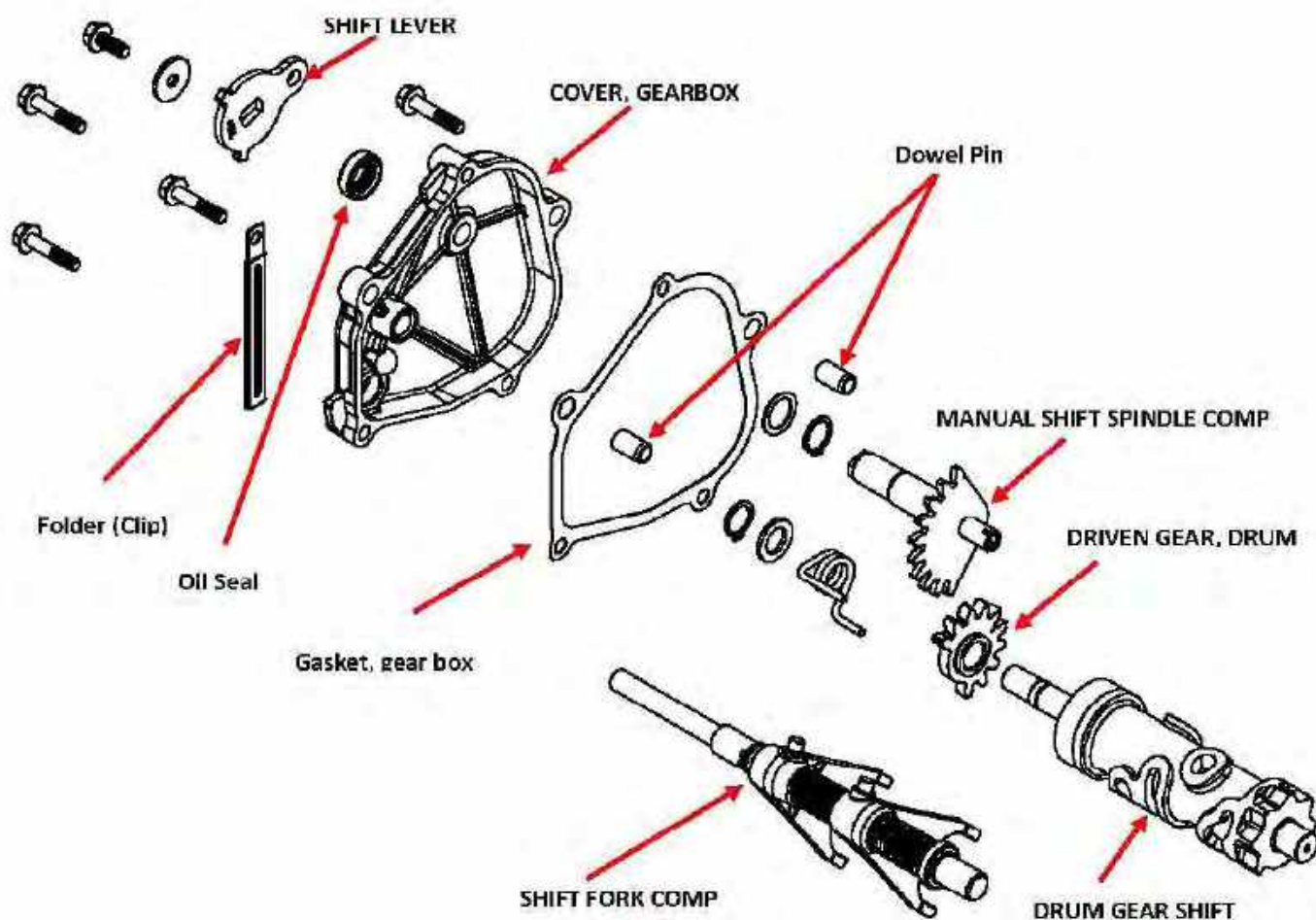

10-02. Trouble Diagnosis

Engine can be started but vehicle cannot move.

- Damaged gear shift system
- Damaged drive gear
- Burnt out drive gear
- Wrong installation
- Worn V-belt

Noise

- Worn or burnt gear
- Worn gear

Gear oil leaks

- Excessive gear oil.
- Worn or damage oil seal

Faulty Gear Shifting

- Foreign object in a shift drum groove
- Seized shift fork
- Bent shift fork guide bar
- Seized transmission gear
- Foreign object between transmission gears
- Improperly assembled transmission

Jumps out of gear

- Worn shift fork
- Incorrect axial play on shift drum
- Worn shift drum groove
- Worn gear dog
- Incorrect shifting gear in running mode

10-03. Gear Shifting Box Disassembly

- a. Loose and remove the flange bolt M6*16 to disconnect the gear shift plate and gear shift lever from engine
- b. Screw out 5 flange bolts (M6*30) on the gear box cover, and open the gear box cover.
- c. Remove the gasket & 2 dowel pins.
- d. Remove out the manual shift spindle
- e. Remove the shifting drum driving gear.
 - Remove the cir-clip on the shaft of shift drum
 - Remove the washer and spring from shift drum
 - Remove the shift drum driving gear.



10-04. Gear box Inspection

- a. Check the gear tooth of manual shift spindle for any wear or damage.
- b. Check the gear tooth of shift drum driven gear for any wear or damage.
- c. Check the shift drive return spring torsion if normal.
- d. Check the oil seal on the gear box cover if oil leaking or damage.



10-05. Gear box re-assembly

1. Put shift drum driven gear on the gear shifting drum

2. Put the shift drive spring, plate washer onto shift driven gear and lock by cir-clip.
 - the two ends of spring should be pushed into the groove of gear shifting drum.

3. Insert the manual shift spindle and align the gear position mark with the shift driven gear.
 - smell some grease on the both teeth and the contact surface on oil seal.

4. Install the 2 dowel pin and gear box gasket

5. Install the gear box cover by tighten the 5 flange bolt.

Torque: value:

M6*30	1kgf-m
M6*16	1kgf-m



NOTE:

11-01. Mechanism
11-02. Precautions in operation
11-03. Trouble Diagnosis
11-04. Transmission Disassembly
11-05. Transmission Inspection
11-06. Transmission Reassembly

11-01. Mechanism Diagram

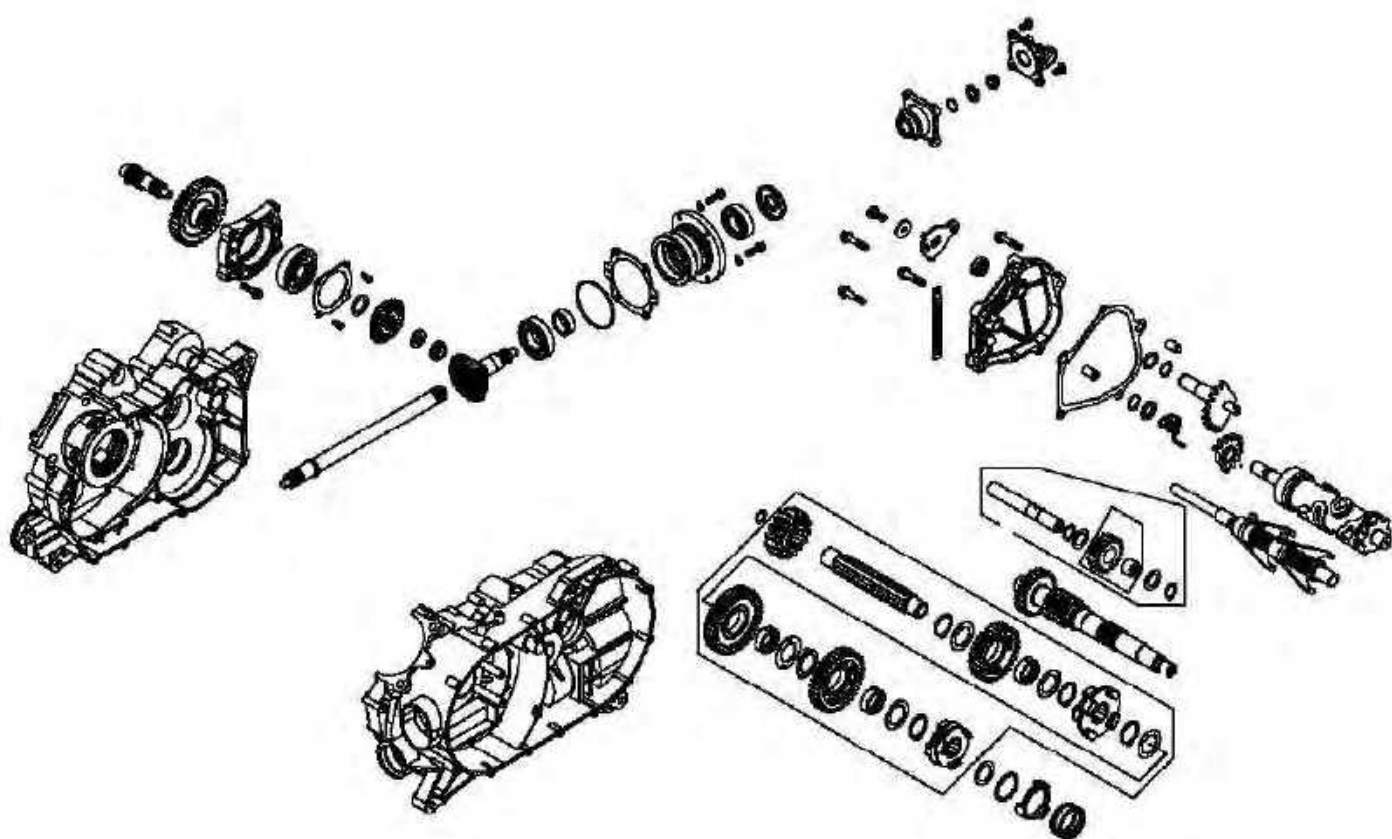

11-02. Precautions in Operation

This Section concerns disassembly of the crankcase for repair purpose.

Remove following components before disassembling crankcase.

- | | |
|--------------------------------|------------|
| – Engine remove | Chapter 5 |
| – Cylinder head | Chapter 6 |
| – Cylinder and piston | Chapter 7 |
| – Drive face and driven pulley | Chapter 8 |
| – AC generator | Chapter 9 |
| – Gear Shifting box | Chapter 10 |

11-03. Trouble Diagnosis

Engine can be started but vehicle cannot move.

- Damaged drive gear
- Burnt out drive gear
- Damaged gear shift system
- Worn V-belt
- Sized transmission gear
- Foreign object between transmission gears

Noise

- Worn or burnt gear
- Worn gear

Gear oil leaks

- Excessive gear oil.
- Worn or damage oil seal

Engine oil leaks

- Worn or damage oil seal/O-ring
- Damage/cracks crankcase
- Crack on mating surfaces of crankcase
- Crack on contact surfaces of delivery pipes.

Jumps out of gear

- Worn shift fork
- Incorrect axial ply on shift drum
- Worn shift drum groove
- Worn gear dog
- Incorrect shift gear in running mode

11-04. Transmission Disassembly

Note:

Before disassembly of the transmission, please refer below chapter to remove necessary parts.

Chapter 3 Lubrication System

Chapter 8 CVT driving system

Chapter 9 A.C. Generator

Chapter 10 Shifting Gear box

Lie down the disassembled engine right side up as picture.

- a. Remove the Cam chain tensioner pivot bolt and then remove Cam Chain tensioner from R. Crankcase.
- b. Remove the socket bolts and stop plate inside the gear shift box chamber.
- c. Remove the 17 flange bolts right crankcase from the left crankcase and then remove the R. crankcase..
 - Working in crisscross pattern from center , loosen each bolt 1/4 of a turn, remove them after all of them are loosened.
 - Use a soft hammer to tap on one side of the crankcase. Tap only on reinforced portions of the crankcase.

Note: Do not tap on the crankcase mating surfaces. Work slowly and carefully. Make sure that crankcase halves separate evenly.

- If hard to separate crankcase R. To use " detached tool" to help to separate crankcase R and L.



- To fix the flat plate to the crankcase R by four bolts and insert the tool to crankshaft.



- Fix the shaft and screw in the nut step by step (3~5 times)to detach the crankcase R evenly.



- Remove the dowel pins and separate crankcase L /R.
Crankcase L with crankshaft, balancer, gear set and gear shift drum.....and so on.
Crankcase R with pinion gear set, oil filter...and so on.



- d. Remove the counter shaft and shift fork as a set.



- e. Remove the shift drum.



f. Pull and remove the reverse idle gear axle ass'y and Primary drive gear Ass'y.



g. Push the gear and clip out the circlip to remove the gear park/spring.



h. Remove out the bolt/cooper washer/spring/ball by wrench.



i. Do not suggest to pull out the bearings/oil seal/stopper/copper plug. If it is necessary to pull out them, please use special tool/puller and handle the operations slowly and carefully.

j. Remove the 4 flange bolts and then remove the output shaft housing.



● Take a note on the "grade" of two shims, be sure the same grade when installing back.



shim
grade

k. Remove the bevel drive gear, output shaft, collar, o-ring from the rear LH. crankcase side.



l. Knock back the nut and remove the nut on drive bevel gear on the right crankcase, then remove the gear and the shim.



- Take a note on the grade of shim and put the same grade of shim when reassembling.



m. Remove 4 flange bolts M8*35, then move the Bevel Bearing housing

n. Remove the driven shaft and driven gear.

o. Remove the drive shaft.

p. Remove the output shaft.



q. Screw out the bolt and remove the oil filter set (with alloy washer/o-ring).



r. Remove the relief valve ass'y with copper washer by wrench.

s. Remove out the velocity sensor.



t. Remove out the selector switch.



11-05. Transmission Inspection

- a. Shift drum -- groove scratches/wear/damage → replace
- b. Shift fork/ guide bar/spring
 - Shift fork
 - groove follower wear/damage → replace
 - fork pawl scoring/bend/wear/damage → replace
 - Guide bar – bends → replace
 - check the movement with fork forward and backward
 - Spring – cracks/damage → replace
- c. Counter shaft Ass'y
 - Remind to take note on the sequence/direction of all components and install them back by notes.
 - Gear teeth – blue discoloration/wear → replace
 - Mated dogs – round edges/cracks/missing portions → replace
 - Axle
 - run-out checking by dial gauge – out of specification → replace
 - run-out limit: 0.03mm**
 - oil passages checking – clogged → blow out with compressed air or clean.
 - Washer/bushing checking – blue discoloration/cracks/wear → replace
 - Check the movement of countershaft after reassembling as a whole set.

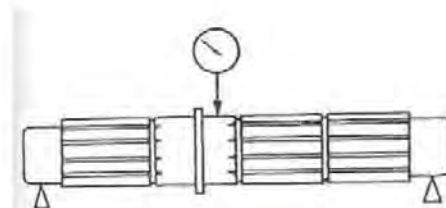
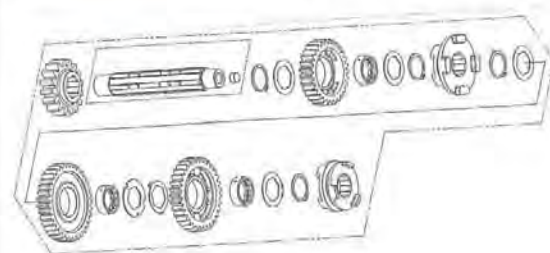

d. Check if the reverse shaft, oil passage and gear teeth – bend, clogged, wear or damage
 → blow or replace

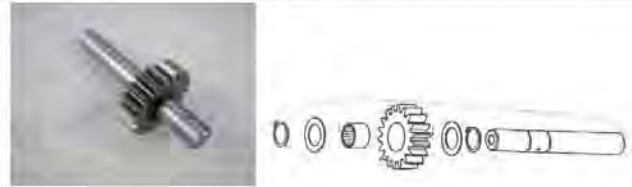

e. Check if the drive shaft and gear -- burn, wear or damage → replace



f. Gear park checking –

- mated dogs rounded -- edge/cracks/missing portion → replace
- compression spring – cracks/damage → replace



g. Check bearings on the left and right crankcase. Clean and lubricate, then rotate each bearing's inner race by fingers.

- Check if the bearings can be rotated smoothly and silently and also check if the bearing outer ring is mounted on gear tightly.
- If the bearing rotation is uneven, noising, roughness, loose bearing mounted, then replace it.



h. Check oil seal for wear or damage, and replace it if necessary.

Caution

- The bearings/seal should be replaced with new one after they are removed from the crankcase by the bearing puller.

i. Check the driven system related components.

- check all spindles conditions
- check all gear teeth conditions
- check all bearings operations
- check all housing conditions
- check all threads on the shafts/pinion gear

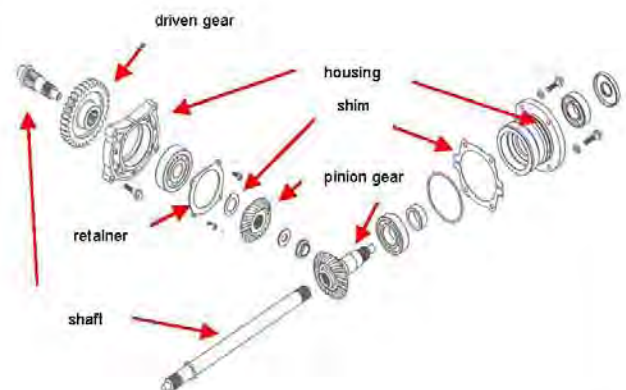

- check retainer – bent → replace
 - check o-ring/oil seal conditions
 - remark the grade on the shims
 - always replace a new nut
- j. Check oil filter and relief valve
- Oil filter
 - contaminants → clean with oil
 - clogged → blow by compression air
 - damage → replace
 - always replace a new o-ring
 - Relief valve
 - clogged → blow by compression air
 - **pressure value: 4.8~6.2 kg-cm²**
- k. Check the crankcase
- Thoroughly wash the case halves in a mild solvent.
 - Clean all the gasket mating surfaces and crankcase mating surfaces thoroughly.
 - Check all oil delivery passages – clogged → blow out with compressed air
 - Crankcase cracks/damage → replace
 - Threads damage → re-tapping/ replace



mating surfaces

11-06. Transmission Re-assembly

Re-install the transmission gears and assembly the RH /LH crankcase in reverse way of dis-assembly.

Attention points as below:

- Always tighten the bolts/screws/nuts in stages, using a crisscross pattern.
- Crankcase R installation
 - install the middle drive shaft/ housing (with bearing and retainer tightened)/ driven gear
 - install the same grade shim as removal



- install pinion gear & washer

- apply the loctite glue on threads(or nut) & tightened the nut. Secure the nut after tightened.

Note: always replace a new nut.



- install the housing set to the crankcase R.



- apply the loctite glue on bolts and tightened.



- install the oil filter & relief valve
 - ◆ apply enough oil on o-ring and install it a 3mm clearance to the wall and tighten the bolt.

- follow the **specified torque**

M6*16	1kgf-m
M8*35	3.2kgf-m
M20 nut	15kgf-m
M6*12	1kgf-m
Relief valve	2kgf-m



● Crankcase L installation

Apply enough oil to the parts before installation (ex. drum, fork, bearings, shafts, gears, oil seal, o-rings... etc).

- install middle driven shaft/ housing/

pinion gear

- ◆ install pinion gear & housing
(assembled with bearings/ collar/
oil seal)
- ◆ install coupling and o-ring and
washer
- ◆ apply loctite glue to the nut and lock
the nut.



- install middle driven shaft ass'y to
crankcase L
 - ◆ put the o-ring t the ass'y & apply
proper oil and install it into
crankcase L evenly by soft hammer
and keep a clearance.
 - ◆ install two shims (same grade as
removal) to the clearance and
screw in the washers & bolts
 - ◆ apply loctite glue to bolts and lock
the bolts.



- follow the **specified torque**

M14 nut	15kgf-m
M8*35	3.2kgf-m

- fix the spring, gear park and clip on.
- install shift drum
- install countershaft & shift fork as a set
to crankcase and follow the grooves of
shift drum



- ensure the contact washers to be
placed correctly.



- install the primary gear & reverse idle gear
- apply enough oil to all installations before combining crankcase L & R.



● Combine crankcase L & R ass'y

Before installing and torquing the crankcase holding bolts, be sure to check whether the transmission is functioning properly by manually rotating the shift cam in both direction.

- apply sealant to the mating surfaces of both cases halves and install dowel pins.
- fit the right crankcase onto the left case, tap lightly & evenly on the case with a soft hammer.



Note: lift the connecting rod to the top not to bump the case.

- tighten the bolts from center and in stages, using a crisscross pattern and torque them.
 - ◆ M8*65 x 4 in the rear right side are in prior.



- fix the shifting bolt/velocity switch/selector switch.



- ◆ apply oil to o-rings and insert the switches to the should-be positions.



- ◆ long pin side of selector switch is neutral gear.



- follow the **specified torque**

M8*65 2.3kgf-m

M6*65 1kgf-m

M6*16 1kgf-m

M6*12 1kgf-m

- check the crankshaft and transmission operation by manual
Unsmooth operation → repair



- Assistance for the combinations

If hard to tap crankcase R to L, a special tool "pusher" to be applied.

- install the pusher to the R side crankshaft.
- lock the nut to the crankshaft
- hold the bar and lock the nut in slowly and evenly by soft hammer tap the other side.



- release the nut and take the pusher out
- process the further steps.



- Manufacture remark " shim grade " posed on the crankcase.
 - Just for a reference.
 - to help a parts ordering.



NOTE:

12-01. Mechanism Diagram
12-02. General Information
12-03. Trouble Diagnosis
12-04. Removal of Crankshaft & Balancer
12-05. Inspection
12-06. Re-assembly

12-01. Mechanism Diagram

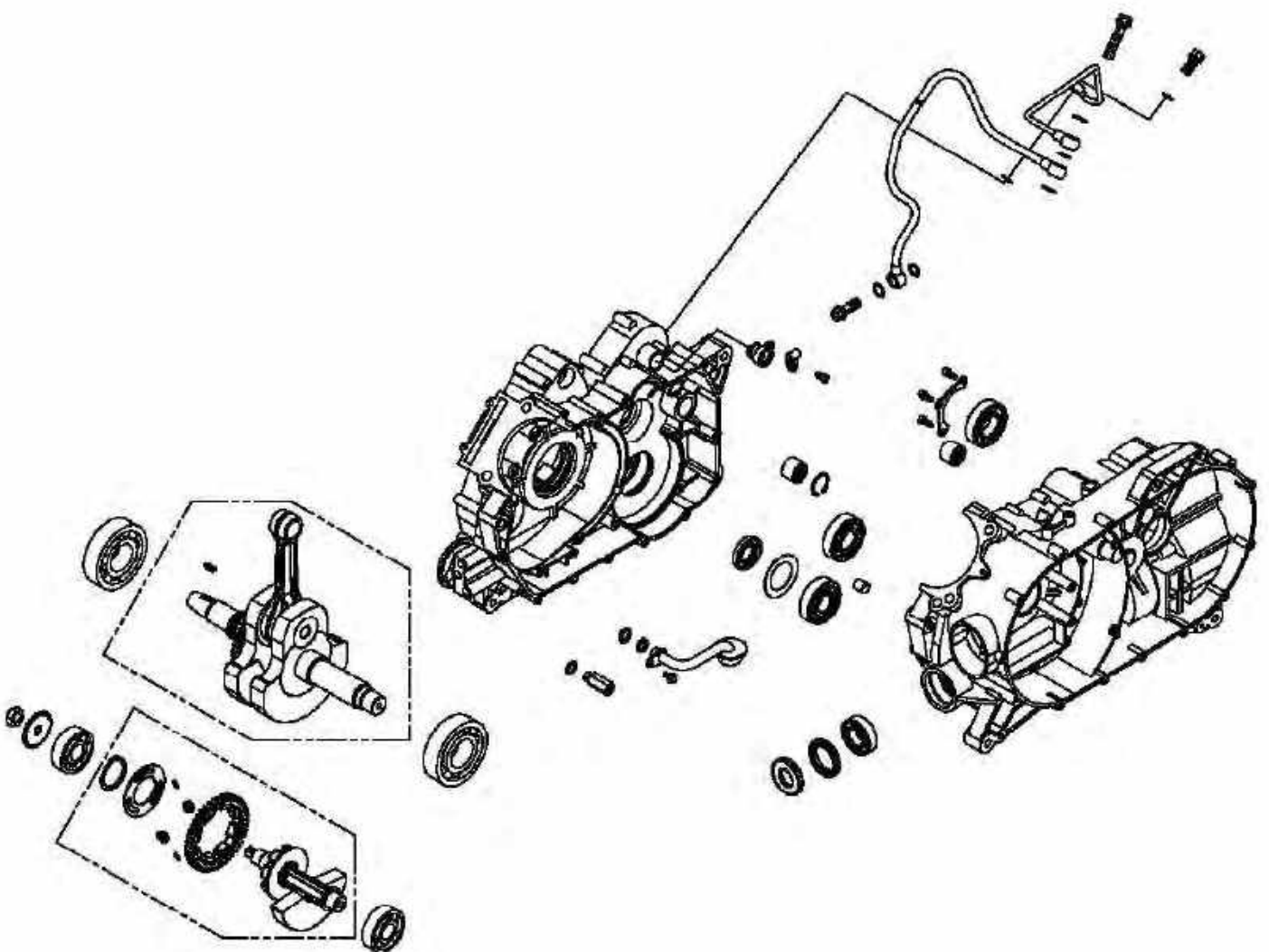

12-02. General Information

Operational precautions

This Section concerns disassembly of the crankcase for repair purpose.

Remove following components before disassembling crankcase.

– Engine remove	Section 5
– Cylinder head	Section 6
– Cylinder and piston	Section 7
– Drive face and driven pulley	Section 8
– AC generator/Start one way clutch	Section 9
– Gear Shifting box	Section 10
– Transmission Gears	Section 11

Tools

Special tools

Crankcase Main Bearing Install Tool:

12-03. Trouble Diagnosis

Engine noise

- Loose crankshaft bearing
- Loose crankshaft pin bearing
- Worn out piston pin and pin hole

12-04. Removal of Crankshaft & Balancer

a. Separating crankcase

1. Place left crankcase downward and right crankcase up.
2. Loosen 17 bolts on the right crankcase.
3. Tap the right crankcase with a plastic hammer to remove it.



Caution

Do not make damage to the contact faces.

4. Refer to Chapter 11.

b. Remove balancer shaft comp.



c. Remove crankshaft from crankcase L.

1. use crankshaft separating tool.
2. screw the tool in the two holes on the CVT side of crankcase L and tip the end of crankshaft.



crankshaft
separating tool

3. turn clockwise to push out the crankshaft

12-05. Inspection

a. Balancer

- check the balancer shaft – damage/ cracks/ bent → replace whole set
- check the drive gear – damage/wear → replace whole set
- excessive noise during operation → replace whole set
- check the pin and spring – wear/damage → replace



Note: align the point to buffer boss and drive gear when installing back.



b. Crankshaft

- Measure
 - crank width A – out of specification → replace crankshaft

Crank width : 75.3 ~ 75.4mm

- crank side clearance D – out of specification → replace crankshaft

Side clearance: 0.3 ~ 0.65mm

Service limit : 1mm

- run-out testing C1 & C2 – out of specification → replace crankshaft

Service limit: 0.03mm

- Checking
 - thread damage → replace
 - gear teeth – wear/damage → replace
 - contact surface – cracks/damage → replace
 - connecting rod – wear/roughness →

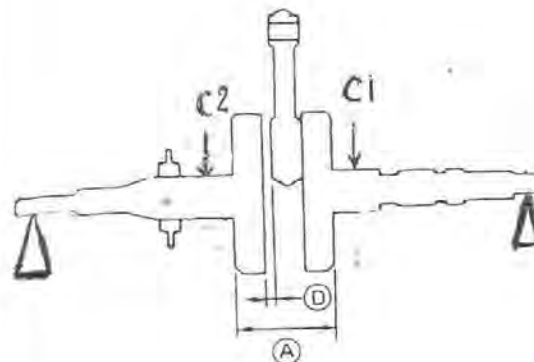

replace

- oil passage – clogged → blow by compressed air
- heat burn → replace

12-06. Re-assembly

- Install crankshaft to crankcase L
Use special tool to pull the crankshaft from right side to the bearings race.

Note: ensure the connecting rod not to bump crankcase.

- Install balancer shaft comp to the crankcase L.

Note: Align the gear tooth of the balancer shaft with crankshaft, and insert onto the Crankcase L.



NOTE:

13-01 General Information

13-02 Technical Specification

13-03 Trouble Diagnosis

13-04 Coolant Check/Replacement

13-05. Radiator Cap/ Reservoir Tank

13-06. Radiator / Cooling Fan

13-07. Water Pump

13-08. Thermostat/Thermostat Sensor

13-01. General Information

WARNING:

Removing the radiator cap while the engine is hot can allow the coolant to spray out, seriously scalding you. Always let the engine and radiator cool down before removing the radiator cap.

CAUTION:

Radiator coolant is toxic. Keep it away from eyes, mouth, skin and clothes.

Test the cooling system for any leakage after the repair.

- If any coolant get in your eyes, rinse them with water and consult a physician immediately.
- If any coolant in swallowed, induce vomiting, gargle and consult a physician immediately.
- If any coolant gets in your skin or clothes, rinse thoroughly with plenty of water.

NOTE:

Use coolant with silicate inhibitors may cause premature wear of water pump seals or blockage of radiator passages. Using tap water may cause engine damage.

13-02. Technical Specification

Item	Specification
Pressure to open filler cap	1.1±0.15 kgf/cm ²
Capacity of coolant: Engine + radiator + hoses	2,500 +/-50 c.c.
Reservoir Tank	300cc +/- 20 c.c.
Thermostat	Begins to activate at 71±1.5°C
Thermos switch (Fan Switch)	Begins to activate at 85±3°C
Boiling point	Not-pressure: 107.7°C Pressurized: 125.6°C

13-03. Trouble Diagnosis

a. The engine temperature is too high

- The water thermometer, Thermo Switch (Fan Switch) sensor do not work properly.
- The thermostat is stuck to close.
- Insufficient coolant.
- The water hose and jacket are clogged.
- Fan motor malfunction.
- The radiator filler cap of the radiator malfunction.
- EFI malfunction checked by OBD.

b. The engine temperature is too low

- The water thermometer and the temperature sensor malfunction.
- The thermostat is stuck to open.
- EFI malfunction checked by OBD.

c. Coolant is leaking

- The water pump mechanical seal does not function properly.
- The mechanical seal/O-rings are deteriorated.
- The water hose is broken or aged.

d. Trouble Diagnosis for Cooling System

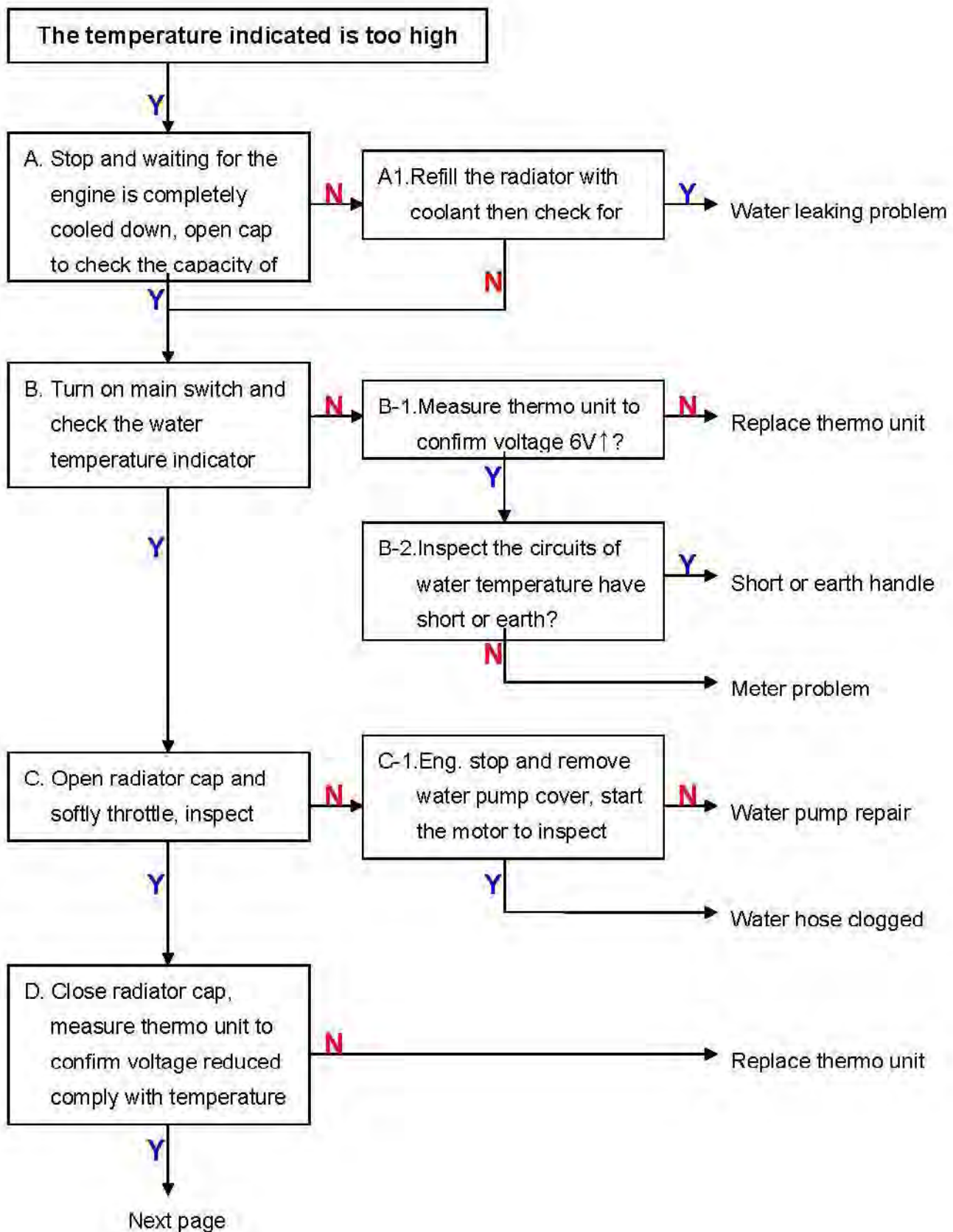

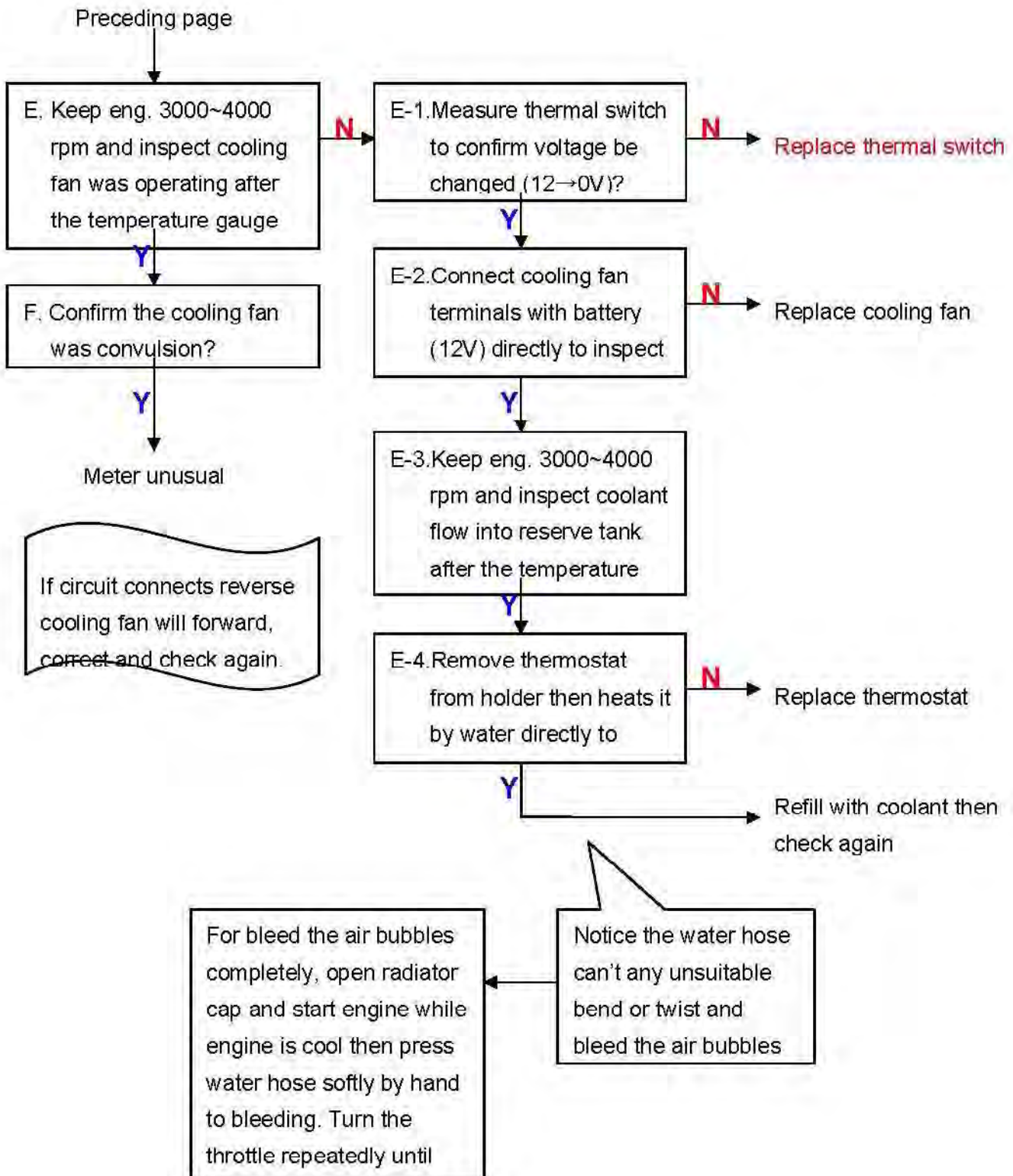

13-04. Coolant Check / Replacement

Warning

Never attempt to work on the cooling system unless the engine is completely cooled down.

a. Coolant check

1. Check the coolant liquid level inside the reservoir tank. Add coolant to the proper level between Min. to Max. if necessary.
2. Remove the front center cover, and then remove reservoir tank filler cap.
3. Add recommended coolant to the Max. level if the coolant is not enough.
4. Greased dirt coolant => replaced
5. Reinstall the reserve tank filler cap and the front center cover.



Caution

Do not over fill the coolant to the reserve tank, to avoid split out of liquid coolant while liquid

Caution: Coolant leaking check.

Check the coolant circular system on radiator / cylinder-cylinder head / water pump and hoses-clamp side if any leaking.

b. Coolant replacement

1. Remove the In hose pipe and four bolts of water pump, then take out the cover of water pump.



In hose

2. Place a water pan under the water pump to reverse the coolant.
3. Refilling system with recommended coolant through the filler opening up to the filler neck.
Bleed the air from the system as follow:
 - a. Start the engine and let it idle for 2~3 minutes.
 - b. Snap the throttle three to four times to bleed air from the system.
 - c. Stop the engine and add coolant to the proper level if necessary. Reinstall the radiator cap.
 - d. Check the level of coolant in the reserve tank and fill to the upper level if it is low.

Caution:

- Use recommended coolant only(Long Life Coolant, LLC 50% density).
- Do not start engine in a frozen coolant.
- Drain out coolant if vehicle stay in outside for frozen weather for a long time and remark " No coolant inside".
- Periodic replacing new coolant helps engine running.
- Check out coolant level in a long-term un-riding.

13-05. Radiator Cap /Reservoir

Tank

13-05-01 Radiator Cap

a. Removal

1. Open the Front center cover
2. Push down and turn the radiator filler cap by counter-clockwise direction to remove the radiator cap.

b. Inspection

Use pressure tester to test the radiator filler cap. Hermetically seal the filler cap, apply water and pressure to the filler cap. Replace it with new one if tester fail to maintain the specified pressure within a given time limit, or the opening pressure is too high or too low. The specified pressure shall be maintained at least for 6 seconds in the test

Relief pressure for the filler cap:

1.1 kgf/cm²

Apply pressure to the radiator, engine and water hose to check for any leakage

Caution

High pressure may damage the radiator. Never use pressure which exceeds

1.1 kg/cm².

If the system fails to maintain the specified pressure for at least 6 seconds, repair or replace parts.

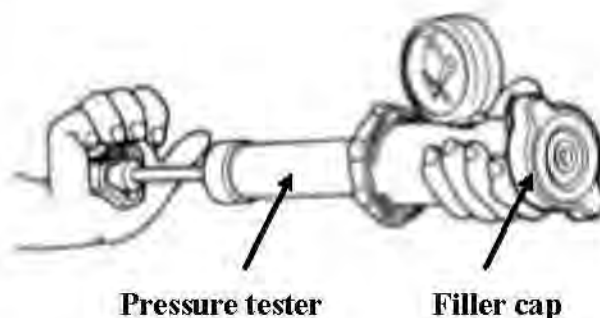

13-05-02 Reservoir tank.**a. Removal**

1. Remove the front covers (refer to Chapter 5, body covers)
2. Use the water pan under the reservoir tank.
3. Disconnect the hose clamp on the radiator filler tube, carefully disconnect the reservoir tank hose from radiator filler tube to drain out the coolant inside the reservoir tank.



Remove the two (2) hex bolt with washer and them remove the reservoir tank from chassis.

Caution:

- Replace the hose clamps if necessary.
- Wipe and dry coolant anytime.

b. Inspection

1. Check the reservoir tank if any cracks, deteriorates or broken, replace with new if necessary.
2. Check the reservoir tank water hose (to radiator filler tube) if any cracks, leaking. Replace with new if necessary.
3. Check the hose and hose clamps if it is being well seated and tightened.
4. Check the cap of reservoir tank, crash => replaced

b. Installation

1. Install the reservoir tank in the reverse way of dis-assembly. Make sure the hose and hose clamps are well seated and installed.
2. Add the coolant into the reservoir tank to the max. level but not over the limit (please ref. 13-04 for detail)

13-06. Radiator / Cooling Fan

13-06-01 Radiator removal.

Note:

Before the removal of radiator and related parts, please process the coolant drain out process as mentioned on 13-04.

a. Radiator assembly removal

1. Remove the water hose clamps on the right upper /lower side of the radiator (Water pump in hose and radiator in hose) and remove the hoses from radiator.



2. Disconnect the water hose of reservoir tank water from radiator filler tube.
3. Remove the Hex. bolt with washer (M6*16) on the radiator cap set and disconnect the radiator cap set from chassis.
4. Disconnect the couplers for the thermo switch and fan motor from wire harness.
5. Loosen the radiator 4 Hex. bolts with washer (M6*22) and then remove radiator Assy (with cooling fan).



b. Radiator filler tube removal

Remove the hose clamp on the radiator side and then disconnect the radiator cap hose.

Screw out the hex. bolt with washer (M6x16) and remove the radiator filler tube with hose.



c. Disassembly of cooling fan

1. Loosen the 4 Hex. bolts with washer (M6x22) from the rear side of radiator, and then remove the cooling fan.

d. Fan Motor Switch removal

Use wrench, turn counter-clockwise to remove the fan motor switch at left middle side of radiator.



Caution

Handle the fan motor switch carefully as it is vulnerable to impact.

13-06-02 Inspection
a. Radiator

1. Use air gun to blow the dust-mud on the radiator and gently clean it by water.
2. Check the radiator if leaking, clogged or damage. Straighten any flattened fins with a thin flat-head screwdriver. Replace with new if necessary.

b. Fan Motor Switch

1. Check the fan motor switch if working correctly.
 - Connect an ohm pocket tester (for continuity test) with the thermo switch.
 - Fill the water in a container, and heat it.
 - Read the temperature by the thermometer gauge while temperature increases by heat.
 - Check the continuity on the pocket tester.

The switch continuity at $85^{\circ}\text{C} \pm 3^{\circ}\text{C}$

c. Cooling Fan

Connect the Fan coupler with battery wire and check the Fan if function properly.

d. Water Hose

Check the water hoses if cracks, leaking or damage. Replace with new if necessary.

e. Radiator defend

- clogged/contaminated=>clean
- crash/torture=>replaced

f. Grommet

- aged/crash => replaced

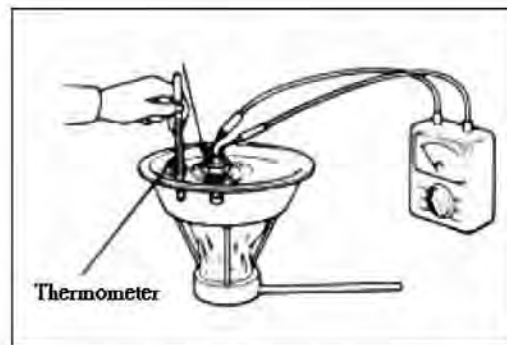
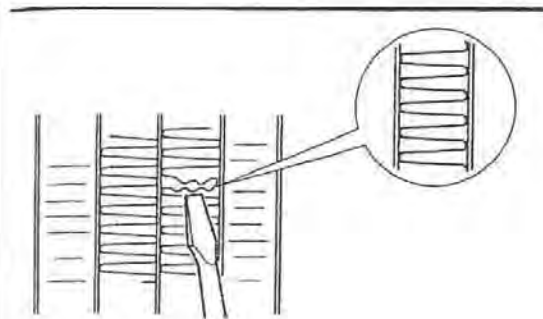

13-06-03 Installation of Radiator Assy.

- Install the removed parts in the reverse order of removal.
- Install radiator in the reverse order of removal.
- Upon completion, re-fill the coolant as mentioned at 13-04.

Installation Torque:

- a. Hex. Bolt with Washer (M6*22) for Radiator: 0.7 kgf-m
- b. Hex. bolts with washer (M6x16) for radiator cap: 0.7 kgf-m
- c. Fan Motor Switch (M6*18): 2.8 kgf-m

13-07. Water Pump

Check water pump seal / cooling system divulges inspection

Unscrew a bolt, overflows little buckles the actually fluid, confirmed overflows the refrigerant whether has the greasy dirt.

Screw out the engine oil drain bolt and let the inside oil comes a little bit, check the engine oil whether does have bleaches situation of the emulsified.

1. If has the above two kind of interior to divulge the phenomenon, possibly for the water pump inner two seal damages or the cylinder head gasket damages, please: First disassemble the water pump cover, to confirm the replacement of water pump seal.

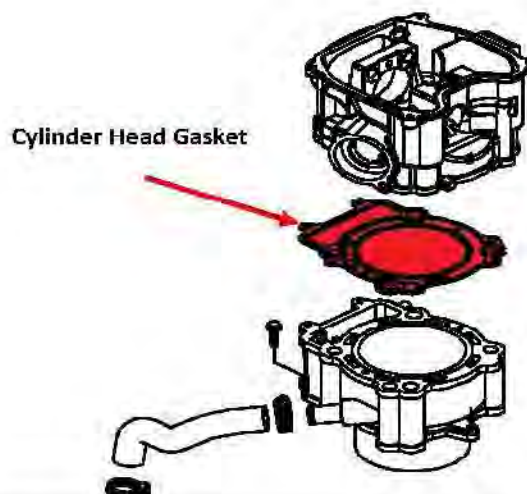
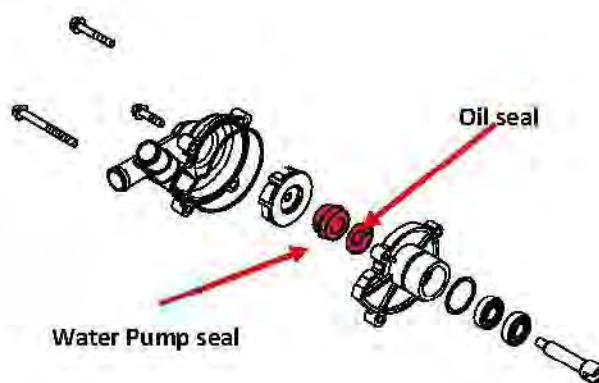

2. If after check the seal is confirm ok, then keep to have advance service check on the cylinder head gaskets of sealing between the cylinder / cylinder head side.

a. Removal of water pump

- Remove clamps of In hose drain out the coolant (refer to 13-04).
- Loosen 4 bolts and remove the pump cover.
- Hold pump base, turning out water pump unit out slightly.

- Turn pump impeller fixing bolt counterclockwise and remove impeller

- Take out impeller shaft and combinations.



b. Inspection

- water pump housing cover
- water pump housing
- impeller
- water pump seal (a pair)
- oil seal / o-rings
- bearings
- impeller shaft
 - tilt check, out of specification => replaced
 - Impeller shaft tilt limit 0.15mm
 - ① straightedge ② impeller

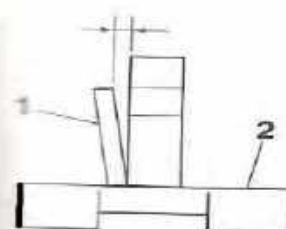
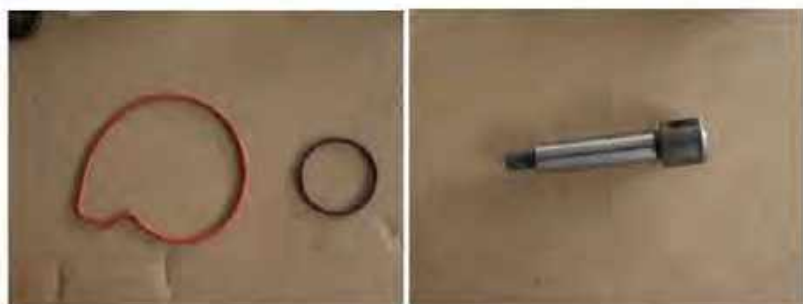

Replace a new one if they are cracks, damaged, wear.

Caution

- The impeller is provided with normal (right turn) thread bolt.
- Always replace new o-rings
- Always replace a pair of water seal set
- Keep a very clean on water seal set

c. Installation

- Install the removed parts in the reverse order of removal.
- Smell lubricant roundly to insert the water pump set turning slightly back to engine case.
- Crisscross fixing the water pump cover.
- Ensure correct direction of all seals.



13-08. Thermostat/Thermo

Sensor

a. Removal of thermostat

1. Drain out the coolant.
2. Remove the thermostat cover (2 bolts) on the cylinder head.
3. Remove the thermostat.

b. Removal of thermo sensor.

1. Use wrench to remove the thermo sensor from cylinder head side. When removing, take care of the ground terminal and wave washer.



c. Inspection (Thermostat)

1. Visually inspect thermostat for any damage.

2. Place the thermostat into water and slowly heat the water, check its temperature indicated.

Technical Data

Valve begins to open	<u>$71 \pm 1.5^{\circ}\text{C}$</u>
Valve stroke	<u>0.5 ~ 8mm</u>

NOTE:

If the accuracy of the thermostat is in doubt, replace it. A faulty thermostat could cause serious overheating or overcooling.

d. Inspection of Thermo Sensor

1. Place the thermo sensor into heated water and keep the wire connected with wire harness,
2. Read the temp. index at speedometer display, compare with temperature gauge at hot water side to check its operation.

Caution

Whenever the thermometer sensor is in contact to the wall of heated water container, the reading displayed may not be correct.

If the valve of the thermostat remains open at room temperature or the valve operation is not corresponding to the temperature change, then it must be replaced.

3. Installation

- Install the thermostat.
 - install the thermostat ① with its breather hole (a) facing up to the inley (b) of cylinder head.
- Install the thermostat cover. (2 bolts)

Torque: Flange Bolt (M6*25): 1.0 kg-m/10Nm

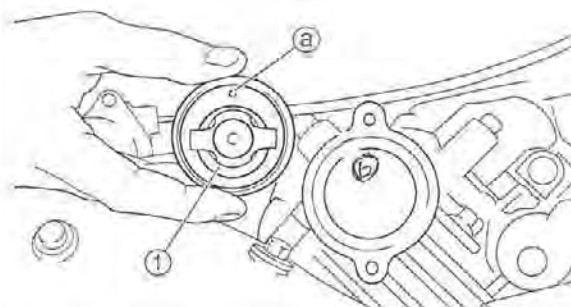

- Install the wave washer, ground terminal and then the thermo sensor with specific torque:
- Refill the coolant and bleed out the air bubble



NOTE:

- 14-01. Mechanism Diagram
- 14-02. Maintenance Description
- 14-03. Trouble Diagnosis
- 14-04. Front Wheel/ Tire
- 14-05. Front Wheel Hub
- 14-06. Disk Brake System Inspection
- 14-07. Adding Brake Fluid
- 14-08. Front Brake fluid replacement / Air-bleed
- 14-09. Front Brake Caliper
- 14-10. Front Brake Disk
- 14-11. Front Brake Master Cylinder

14-01 Mechanism Diagram

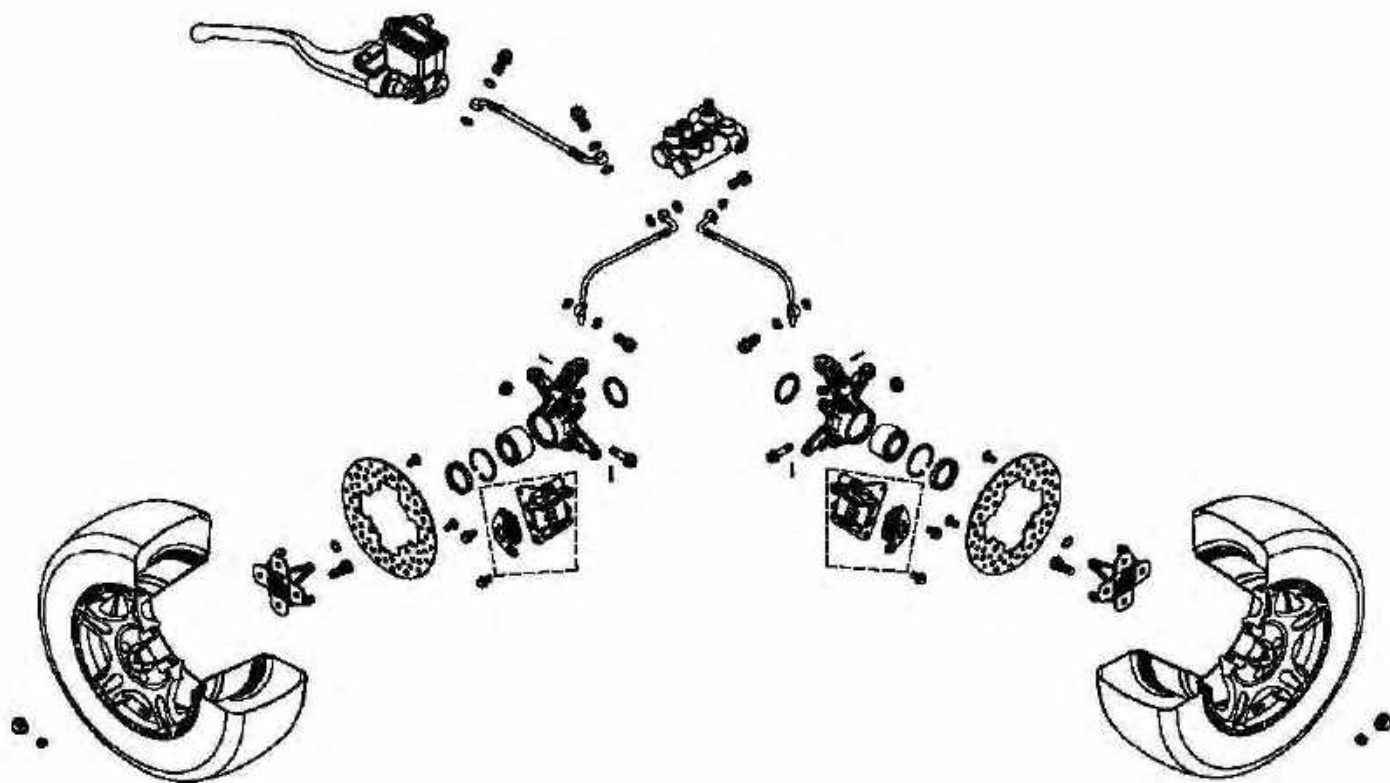

14-02. Maintenance Description

a. Operational precautions

Caution

- During servicing, keep oil or grease off the brake pads and disk.
- Drain the brake fluid from the hydraulic brake system before disassembly.
- Clean the contaminated brake disk with high-performance brake degreaser and replace the brake pads.
- The brake caliper can be removed without removing the hydraulic system.
- After the hydraulic system is removed, or the brake system is soft, bleed the air out of hydraulic system.
- While refilling brake fluid, care should be taken not to let the foreign material entering into the brake system.
- Do not spill brake fluid on the painted surfaces, plastic or rubber parts to avoid damage.
- Check the operation of the brake system before riding.
- Make sure to use recommended brake fluid.
- Please refer to the service manual of tubeless tire in respect to the removal, repair and installation of the tire.

b. Specifications

Item	Standard (mm)	Limit (mm)
The thickness of front brake disk	3.50	3.0
The thickness rear brake disk	5.0	4.5
Front and rear brake disk eccentricity	< 0.1	0.3
Master cylinder inner diameter	14.000~14.043	14.055
Master cylinder piston outer diameter	13.957~13.984	13.945
Diameter of front disk	220mm	-
Diameter of rear disk	200mm	-
Thickness of brake lining	4.5	1.5

Tire pressure as cold: 8(7) psi (on road tire)
 5(3.5) psi (off road tire)

14-03. Trouble Diagnosis

Soft brake lever

1. Air inside the hydraulic system
2. Hydraulic system leaking
3. Worn master piston
4. Worn brake pad
5. Poor brake caliper
6. Worn brake lining/disk
7. Low brake fluid
8. Blocked brake hose
9. Warp/bent brake disk
10. Bent brake lever

Uneven brake

1. Dirty brake lining/disk
2. Poor wheel alignment
3. Clogged brake hose
4. Deformed or warped brake disk
5. Restricted brake hose and fittings

Brake noise

1. Dirty lining
2. Deformed brake disk
3. Poor brake caliper installation
4. Imbalance brake disk or wheel

Steers to one side

1. Bent tie rods
2. Wheel installed incorrectly
3. Unequal tire pressure
4. Incorrect wheel alignment

Hard operation of brake lever

1. Blocked brake system
2. Poor brake caliper
3. Blocked brake hose
4. Seized/worn master cylinder piston
5. Bent brake lever

Tight brake

1. Dirty brake lining/disk
2. Poor wheel alignment
3. Deformed or warped brake disk

Hard steering

1. Faulty tire
2. Insufficient tire pressure

Front wheel wobbling

1. Faulty tire
2. Worn front brake drum bearing
3. Bent rim
4. Axle nut not tightened properly

14-04. Front Wheel/Tire

a. Removal

Raise the front wheels with tires off the ground by placing a jack or other support under the frame.

Remove the front wheel nuts, and then remove front wheels.

b. Inspection (refer to 2-08)

1. Check the wheel rim if any cracks, distorts or damaged. Replace with new if necessary.
2. Check the tire
 - Surface – wear/damage → replace

Tire wear limit front/rear : 3.0mm

- Measure cold tire pressure refer to standard tire pressure.
Out of specification → adjust

c. Installation

1. Install the front wheel/tire and tighten the nuts.
 - Install each nut with its tapered side towards the wheel.
 - The arrow mark on the tire must point in the direction of wheel rotation.

Torque: 5.5kg-m / 55 N-m

Note: Always balance the wheel when tire or wheel has been changed or replaced.

Warning:

- Never attempt even small repairs to the wheel.
- Ride conservatively after installing a tires to allow it to seat itself properly on the rim.
- It's dangerous to ride with a worn-out

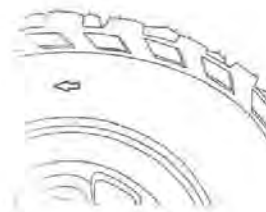
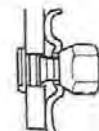
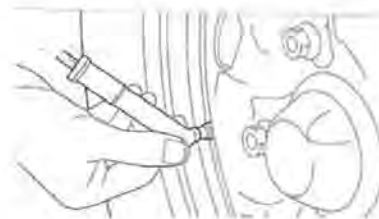
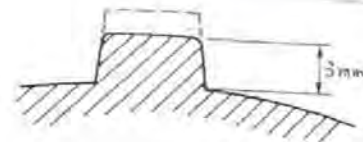

tire when tire wear is out of specification, replace the tire immediately.

14-05. Front Wheel Hub

a. Removal

- Remove the 2 flange bolts (M8*16) between caliper bracket and knuckle, and then remove front brake caliper.
- Use screw driver and hammer, to knock back the locked wall of wheel flange bolt.
- Remove the front LH/RH wheel hub nut and washer and remove wheel hub with brake disk.
- Remove 4 button bolts (M8*17), and then remove the brake disk from wheel hub.

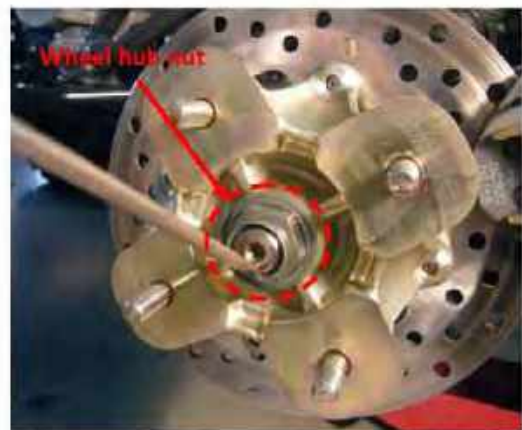
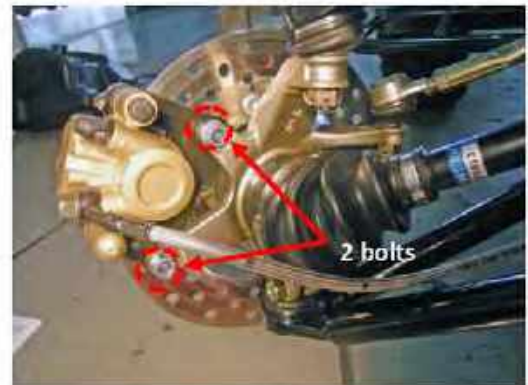

c. Installation

1. Install the brake disc to the front wheel hub.
Be aware the recessed portion of the bolt hole faces away from the hub.

**Torque: Brake disk button bolts (M8*17)
3.5kgf-m**

2. Clean and grease the front LH/RH drive axle (outside of Knuckle)
3. Put the O-ring onto the front LH/RH drive axle
4. Install wheel hub into the front LH/RH drive axle.
5. Apply the glue to the wheel hub locknut

6. Tighten the wheel hub nut with specific torque. Stake the collar wall of the nut into the notch of the shaft.

- Always replace a new nut.

Note: Install wheel hub nut (M20).

Torque: 26kgf-m / 260 N-m

7. Install the caliper (with bracket) to the knuckle by tighten the flange bolt (M8*16)

Note: Install front brake caliper.

**Torque: Bolt, brake caliper bracket (M8*16)
2.5kgf-m/25 N-m**

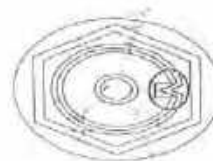
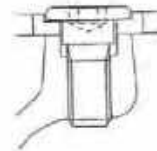

14-06.Disk Brake System Inspection

a. Inspection

1. By visual examination whether fluid leaking or the damage on the brake hose side, the connecting bolts washer side, and caliper body side.
2. Turn the handle left and right, pressure to the front shock, to check if there any interfere, abnormal pull & push on the hose side.
3. Check the brake from inside the brake caliper. The brake pad must be replaced with new lining when the brake pad wears to the service limit.

Note:

Remove the front wheel rim before the front brake lining check.

- Park the ATV on a plane ground, and check the master cylinder screen if fluid level is under the "LOWER" mark. If yes, check the brake system if any leaking, and add the sufficient brake oil into the master cylinder.

Recommended Brake Fluid:
BRAKE FLUID (DOT 4).

Caution

- a. If the vehicles being parked inclined or just stopped, the survey of brake oil level could not be accurate, it is better to settle the vehicle 3~5 minute before checking.
- b. In order to prevent chemical deteriorate and cause bad performance on braking power or even lead to a accident, please always use recommended brake fluid.

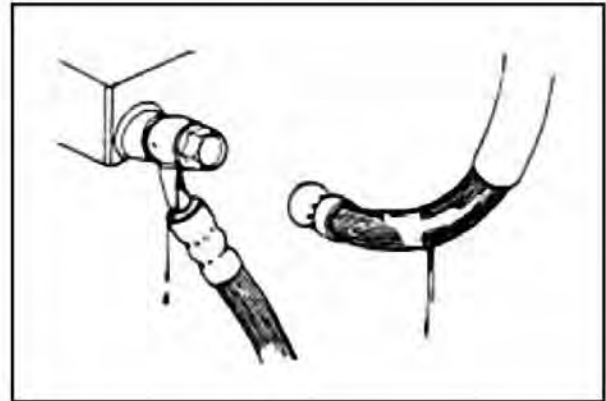

- c. Do not mix different specs. of the brake fluid.
- d. Replace brake fluid at once it's dirty.
- e. Always check brake fluid level before riding.

14-07. Adding Brake Fluid

Note:

Before the brake fluid reservoir cap is removed, turn the handle to keep the fluid inside the master cylinder at horizontal.

- a. Screw out 2 screw on the master cylinder cap and remove the master cylinder cap and diaphragm.
- b. Add high quality brake fluid, uses only trade mark brake fluid joins in master cylinder.
- c. Put back the diaphragm and master cylinder cap, and press the brake lever slightly, to check if brake force is firm and solid. If there is soft still while apply the brake lever, check and do the air bleeding procedure to get rid out of air inside the brake system.
- d. Check again the oil level between the upper and lower limit, and tighten the bolts to close the master cylinder

Caution

When add the brake fluid, please do not surpass the upper limit, spilled brake fluid on painted surfaces, plastic or rubber components may result in damages.

Caution

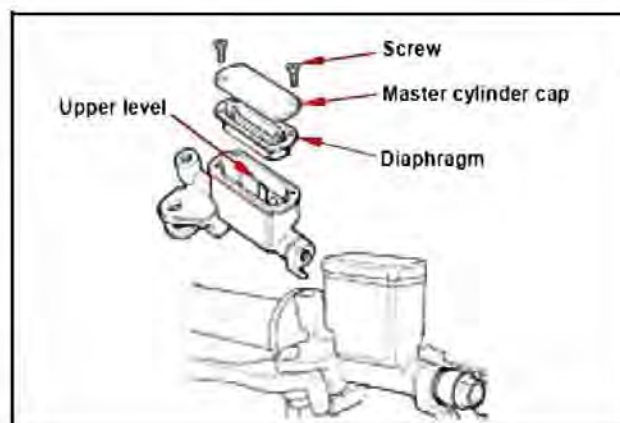

- The dirty brake lining or disk will reduce the brake performance.
- To mixed non-compatible brake fluid will reduce brake performance.
- Foreign materials will block the system causing brake performance to be reduced or totally lost.
- Be careful that water doesn't enter the brake master cylinder when refill. Water will significantly lower the boiling point of the brake fluid and may result in vapor lock.

14-08. Front Brake fluid replacement / Air-bleed

Do the air bleeding / brake fluid replacement process below when there is soft while apply the front brake lever or replace the new brake fluid.

- Connect a transparent drain hose to air-bleed valve on the one side of the front caliper and place an oil container to collect the exhaust brake fluid.
- Open the master cylinder cap and diaphragm at right side of handle bar,, check and add the brake fluid while doing the below air bleeding process.
- Open the drain valve around 1/4 turns on the caliper and keep applying the front brake lever.
- Checks the drain hose for the air bubble flow while apply the brake lever. Close the air bleeding bolt until there is no air bubble comes out/ brake fluid become clear (new)
- Do the same procedures on another front caliper to drain out the air bubble / replace the brake fluid.
- Apply the brake lever to check if the brake feeling is firm and solid.

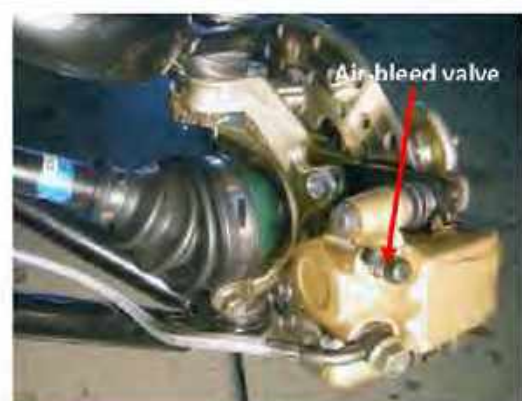

- g. Add front master cylinder the brake fluid to the level between upper and lower limit and closed the master cylinder.

Note:

- You can use the vacuum machine to drain out the air bubble /replace the brake fluid, instead of applying the brake lever.
- Use shop towels to cover plastic parts and coated surfaces to avoid damage caused by splash of brake fluid.

Recommended brake fluid:
DOT 4 brake fluid

14-09. Front Brake Caliper

a. Front Caliper Removal

- Remove the 4 flange nuts (M10) and remove the front wheel.
- Remove the 2 flange bolt (M8*16) on the knuckle and remove caliper (with bracket) from knuckle firstly.
- Place a container under the brake caliper, and loosen the brake hose bolt, to drain out the brake fluid and finally remove the brake hose. *(No need to do this while inspection/replace of the brake pad, unless you have to replace defect caliper/brake hose)*

b. Brake pad removal(if brake pad lining reach to the service limit)

1. Push the bracket and take out the brake pad set.
2. Push the brake piston back to the inner of caliper, if there no symptom of brake fluid leaking.

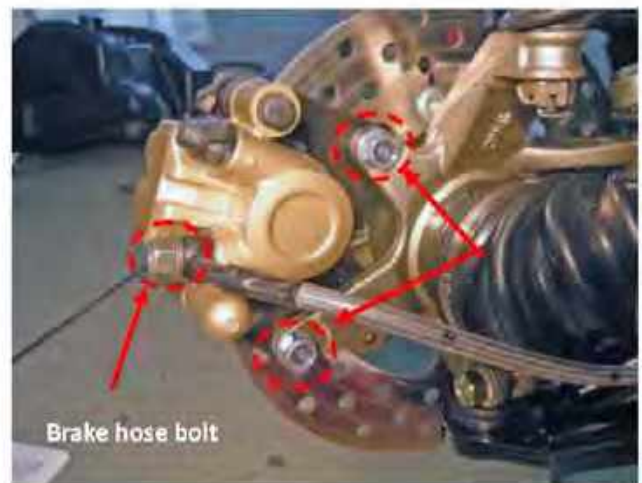

c. Inspection

1. Check the oil hose if any cracks, oil leaking at connecting or hose itself side. Replace with new if leaking found.
2. Check the caliper inner piston/ oil seal if any oil leaking. Replace with new caliper ass'y when oil leaking found.
3. Check the brake pad lining thickness:
Standard: 4.5mm (a)
Service limit: 1.5mm (b)

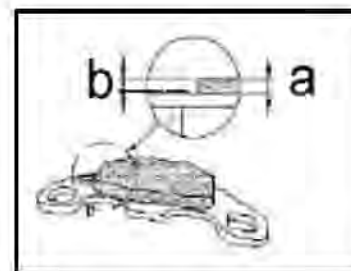
d. Installation of brake pad and caliper to the knuckle.

1. Install the brake pad set into brake caliper.
2. Use two copper washers and hose union bolts (M10*22) to lock the brake hose and install the brake house to the caliper. (If the brake hose is being removed from caliper.)

Torque: Union bolt (M10*22) for brake hose
3.0kgf-m / 30 N-m

3. Install the brake caliper and tighten the bolts securely.

Torque: Caliper bracket bolt (M8x16mm)
3.0kgf-m/30 Nm

Caution

1. Use M8 x 16 mm flange bolt only.
2. Longer bolts will interfere the operation of brake disk.
3. Process the air bleeding/brake fluid replacement procedures that mentioned at 14-08.

14-10. Front Brake Disk

a. Inspection

1. Visually check the brake disk for wear/ break or distorted.
2. Measure the thickness of the disk by dial gauge at several places. Replace the disk if it has exceeded the service limit.

Standard Value: 3.5mm

Service limit: 3.0 mm

3. Remove the brake disk from wheel hub.
4. Check the disk for deformation.

Standard: 0.20 mm or below

Service limit: 0.30 mm

Caution

The dirty brake lining or disk will reduce the brake performance.

14-11. Front Brake Master Cylinder

a. Front Master Cylinder Removal

1. Disconnect the front brake switch wire coupler from wire harness.
2. Remove the two socket bolts on the master cylinder holder, and then remove the front master cylinder set.
3. Put the oil pan at ground, remove the union bolt (M10*22) and two copper washer, and disconnect the front upper brake hose with Fr. Master cylinder. Be careful not to split out the brake fluid onto any plastic / paint items. (only for service need if necessary)

Caution



1. Do not let foreign materials enter into the master cylinder oil reservoir tank.
2. For your own safety and reliability of braking power, factory do not suggest customer to repair a defect master cylinder / caliper. If possible, always replace with master cylinder assy (master cylinder, piston, spring, diaphragm and cir-clip) when parts being diagnose as defect.

b. Master Cylinder Install

1. Align the installation punch mark on the handle bar, place the master cylinder onto handlebar, and install the socket bolts.
2. Connect brake hoses with union bolt (M10*22) and 2 new copper washers. Tighten the brake hose union bolt to the specified torque value.

Torque: 3.0 kg-m / 30 N-m

3. Install brake switch to the master cylinder .

Caution

1. Improper hose routing may damage leads, hoses or pipes.
2. Wrong brake leads, hose or pipe may reduce brake performance.
3. Add specified brake fluid and bleed the system.



Notes:

15-01. Mechanism Diagram
15-02. Operation Precautions
15-03. Trouble Diagnosis
15-04. Steering Handle
15-05. Steering Column
15-06. Steering Tie-Rod
15-07. Front Steering Knuckle
15-08. Front Suspension
15-09. Suspension A- arm
15-10. Toe-In

15-01. Mechanism Diagram

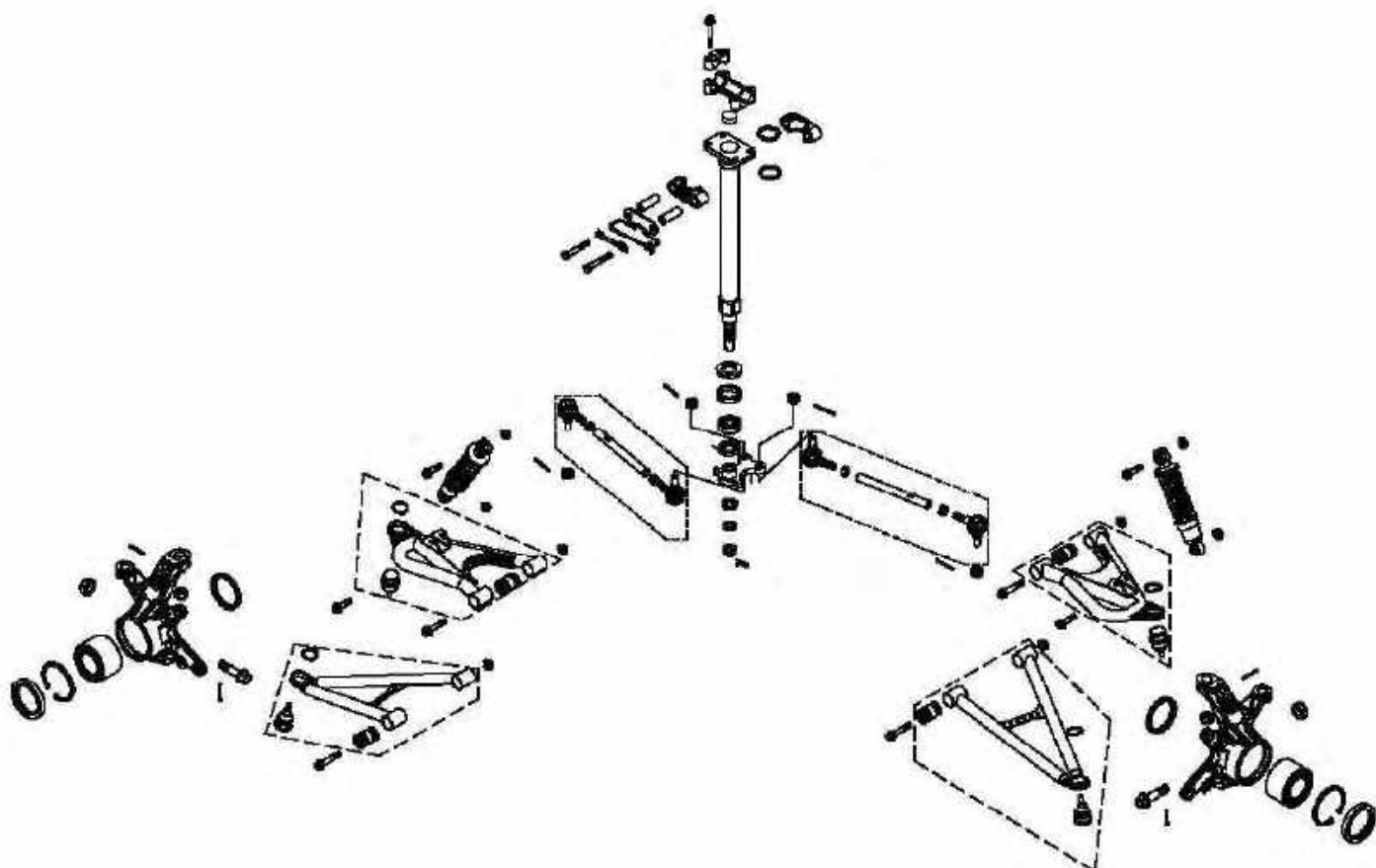

15-02. Operational Precautions

Torque

Handlebar upper holder bolt(M8*50)	2.3kg-m/23 Nm
Steering column (stem) holder bolt(M8*60)	2.3kg-m/23 Nm
Steering column (stem) lower lock nut(M14)	18 kg-m/180 Nm
Steering tie-rod castle nut (M10)	3.0 kg-m/30 Nm
Knuckle nut (M10)	4.8 kg-m/48 Nm
Suspension arm nut (M10)	4.5 kg-m/45 Nm
Front shock absorber mounting nut(M10)	4.5 kg-m/45 Nm

15-03. Trouble Diagnosis

Hard to steer

- Faulty tire.
- Steering shaft holder too tight.
- Insufficient tire pressure.
- Faulty steering shaft bushing.
- Damaged steering shaft bushing.
- Bent or damaged frame

Front wheel wobbling

- Faulty tire.
- Worn front knuckle bearing.
- Deformed wheel
- Incorrect wheel balance
- Axle nut not tightened properly.
- Damaged wheel bearings
- Excessive wheel runout
- Bent or loose wheel axle

Steers to one side

- Bent tie rods.
- Wheel installed incorrectly.
- Uneven tire pressure.
- Uneven tire wear
- Bent frame.
- Worn swing arm pivot bushings.
- Incorrect wheel alignment.

Front suspension noise

- Loose front suspension fasteners.
- Binding suspension link.
- Leaking oil
- Bent or damaged damper rod
- Fatigued or damaged shock absorber spring

Hard suspension

- Faulty front swing arm bushings.
- Improperly installed front swing arms.
- Bent front shock absorber swing rod.

Soft suspension

- Weak front shock absorber springs.
- Worn or damage front swing arm bushings.
- Leaking oil

15-04. Steering Handle

- **Removal**
- Remove the handlebar upper cover.

- Loosen the two socket bolts at right handle side, and then remove the front brake master cylinder and parking brake lever set.
- Remove 2 socket bolts, and then remove RH Handle switch ass'y from right handle side.

- Remove the 2 socket bolts on the winch control switch bracket, and remove the winch switch.

- Loosen the 2 socket bolts for the rear brake master cylinder & parking brake, and remove rear brake master cylinder.



- Remove the 2 pan head screws (M5*30 & M5*40) on the left handle switch assy, and remove the left handle switch assy.



- Remove handle mounting flange bolt (M8*50), and then remove the handle upper holder and handle bar.



- **Inspection**

Handlebar – Bends/Cranks/Damaged → Replace

- **Installation**

1. Install in reverse order of removal procedures.
2. When install the handle bar in the middle side of the handle bar, be sure to aim the align point in the front horizontal connecting surface
3. The upper handlebar holder should be installed with the punched mark ① forward ②.
4. First tighten the bolts ③ on the front side of the handlebar holder, and then tighten the bolts ④ on the rear side.
5. When install the RH handle switch, be sure to align the punch point mark

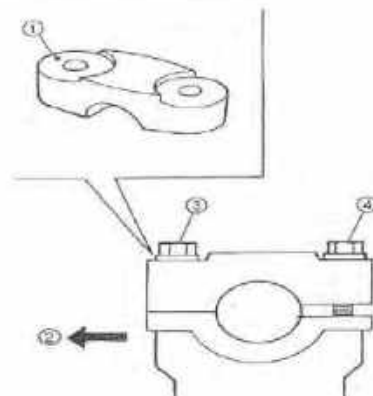

6. Torque value
 - Handle mounting flange bolt (M8*50)
2.3kgf-m/23Nm

- Pan head screw (M5*30&M5*40) for LH Handle switch.
0.45~0.60 kg-m /4.5~6 Nm
- RH Handle Switch socket bolt(M6x22mm):
1.0 kgf-m/ 10 Nm
- Master Cylinder (RH/LH) socket bolt (M10):
3.0kgf-m/30Nm
- Pan head screw (M6) for choke cable.
0.8~1.0 kgf-m /8~10 Nm

15-05. Steering Column

a. Remove

1. Remove cotter pins, and loosen right and left steering tie-rod nuts, then remove the tie-rod.
2. Remove the cotter pin of steering column, and remove column flange nut (M14) and washer. Then take out the pitman arm from spindle of column.
3. Loosen 2 Hex. bolts (M8*60) , and then remove steering column (stem) cable guide plate, lock washer and steering column.
4. Pull out steering column upward out.



b. Inspection

- Check column – wear/ damage/ bend
→ replace
- Check steering stem bushings --
wear/damage → replace
- Check bearing/oil seal inside chassis –
roughness/damage → replace
 - Bearing had been installed into chassis
and stopped by retainer.
 - Retainer had been screwed into chassis
with loctite glue by tool.
 - ◆ **Torque value: 6.5 kgf-m**
 - Covered by two oil seals to be away
from water and dust.
- refer to 2-17.

c. Installation

- Install in reverse order of removal
procedures.
- Apply with grease onto steering column and
pitman arm.

Note:

- Steering column spindle groove should be
inlaid to spindle groove of pitman arm on
matching " · ".

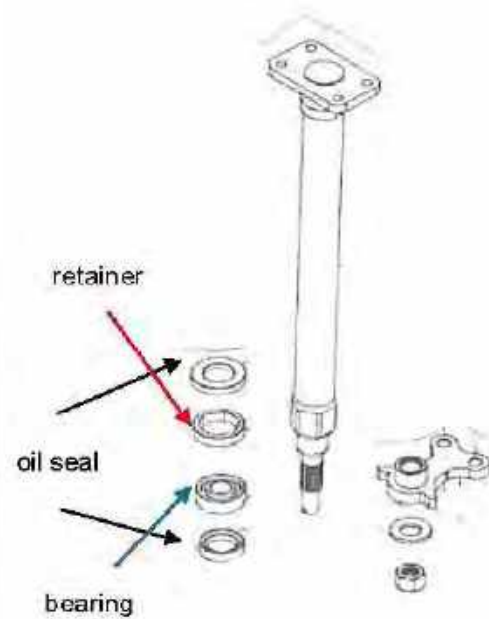

- Bend the lock washer tab along a flat side of the bolt.

Torque:

- Steering column (stem) holder hex. Bolt (M8*60): **2.3 kgf-m / 23Nm.**
- Steering column flange nut (M14): **18 kgf-m/180 Nm**
- Steering tie-rod castle nut (M10): **2.5 kgf-m / 25Nm**

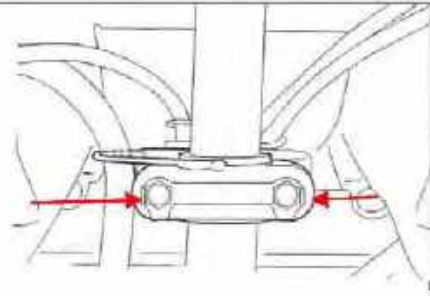

15-06. Steering Tie-Rod

a. Remove

1. Remove the LH/RH front wheel & Hub (refer to Chapter 14)
2. Remove cotter pin and tie-rod nut from lower steering column side and disconnect the LH/RH tie rod from pitman arm.
3. Remove cotter pin and tie-rod nut from LH/RH steering knuckle side, and then remove the tie-rod.

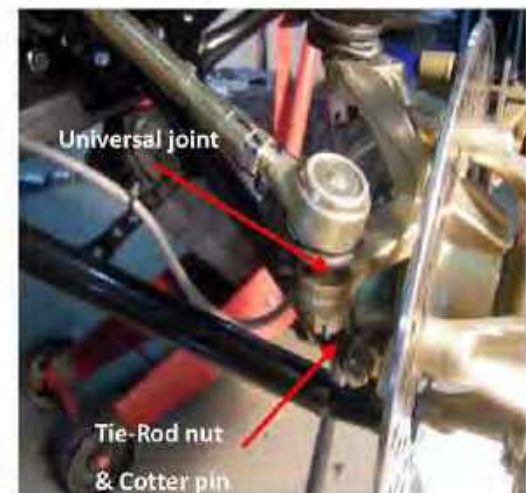
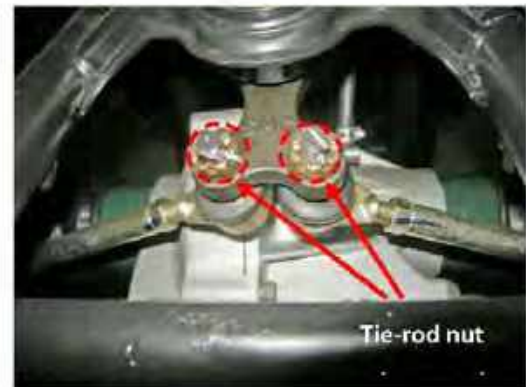

Note: Use a general puller to separate the ball joint ② and steering knuckle ①.

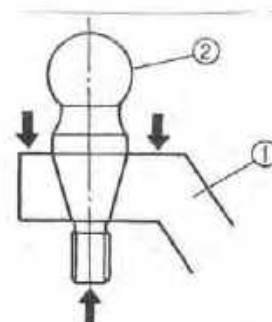

b. Inspection

1. Inspect the tie-rod for damage or bending → replace
2. Inspect on tie-rod ends if damage, wear or deterioration → replace
3. Turn roughly → replace the tie-rod ends.

c. Installation

1. Install by the reverse way of removal.
2. Adjust the adjusting nuts on both sides to process toe-in adjustment (refer to 2-20).
3. Install tie-rod castle nuts, and tighten the nuts

Torque: Steering tie-rod castle nut (M10):
2.5kgf-m / 25Nm

4. After tightened the tie-rod nut, install the cotter pin.

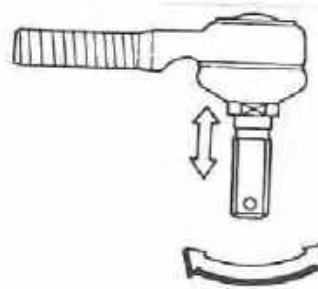
15-07. Front Steering Knuckle
a. Remove

1. Remove front wheel, front brake caliper, front wheel hub and brake disk as mentioned on chapter 14.
2. Remove cotter pin and tie-rod castle nut, then remove tie rod on the Fr. LH/RH knuckle side as mentioned on 15-06.
3. Remove cotter pin, universal joint castle nut, and then disconnect the knuckle with upper A-arm.
4. Remove cotter pin, universal joint keyhole bolt & nut at lower A-arm side, and then remove the knuckle from Front LH / RH drive axle.

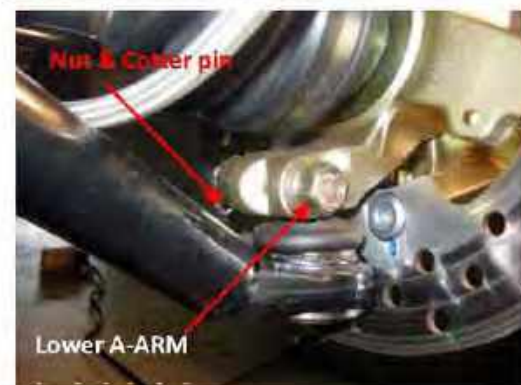

b. Inspection

1. Inspect on universal joint at rubbers if damage, wear or deterioration.
2. Turn the universal joint with fingers. The ball joints should turn smoothly and soild.
3. Check the two bearings ② inside the Fr. LH/RH knuckle. Replace it with bearing puller if bearing is wear/damage or turn roughly.
4. Check the two side of oil seal ① inside the Fr. LH/RH knuckle if damage. Replace it with new if necessary.

c. Installation

1. Install in reverse order of removal procedures.
2. If replace the bearings:
Steps as followings:
 - Clean the outside of steering knuckle
 - Remove the oil seals ①
 - Drive out he bearing ②
 - Apply lithium base grease to the bearings and oil seals.
 - Replace a new cir-clip to the steering knuckle and correctly installing.

Torque: Upper & Lower A-ARM universal joint nut (M10): 4.8 kg-m / 48Nm

3. After tightened the nuts, install the cotter pins.

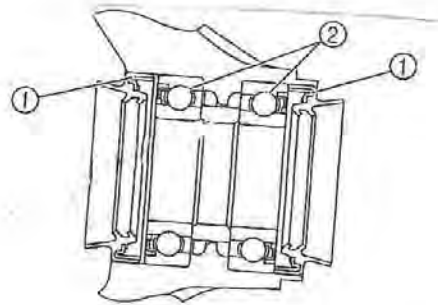

15-08. Front Suspension

a. Remove

1. Remove front shock absorber under nut and flange bolt on the upper A-arm.
2. Remove front shock absorber upper nut & flange bolt, and then remove the front shock absorber.

b. Inspection

- Shock absorber rod
Bends/damage → replace
- Shock absorber ass'y
Oil leaks → replace
- Spring
Fatigue → Replace
Move the spring up and down.

Warning:

Unbalance setting on the RH & LH front shock absorber may lead to steering difficult, lean or even roll, end in result with accident (refer to 2-16).

3. Installation

- Install in reverse order of removal procedures.
- Refer to 15-08

Torque:

Fr. shock absorber upper and lower nylon nut: **4.5 kgf-m (45 N-m)**

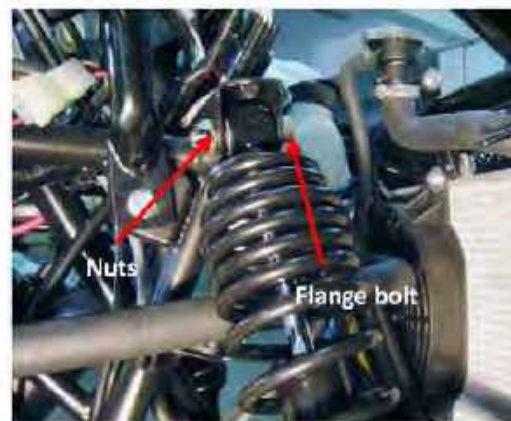
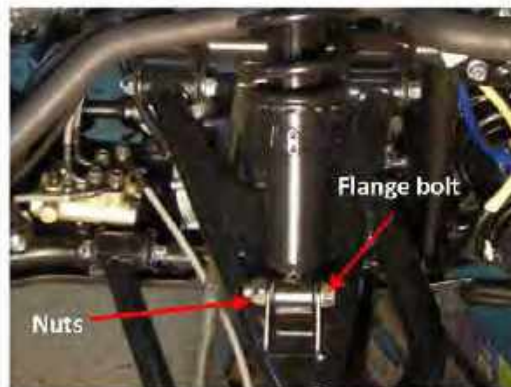

15-09. Suspension A-Arm

a. Remove

- Remove front wheel, wheel hub, and brake caliper, brake disk, tie-rod, knuckle and front shock absorber as mentioned at previous section. .
- Loosen upper suspension arm nuts (M10), remove A arm flange bolts (M10*70), and then remove the upper suspension arm. (Upper A-arm).
- Loosen under suspension arm nuts, remove swing arm bolts and then remove under suspension arm (lower A-arm).

b. Inspection

Checking steps:

- Check the front arm side play A by moving it from side to side. If side play is noticeable, check the bushings.
- Check the front arm vertical movement B by moving it up and down. If the vertical movement is light or rough, or if there is binding, checking the bushings.

Checking the front arm:

- Front arms ① – Bends/damage → replace
- Bushings ② – wear/damage → replace

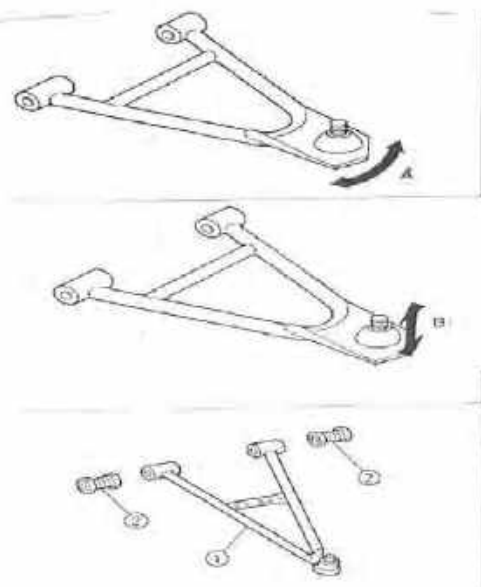
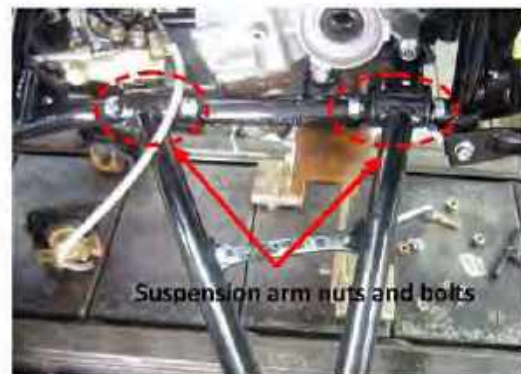

c. Installation

- Install in reverse order of removal procedures.
- Install front arms and shock absorbers

Steps:

- Install the front arm (upper) ① and front arm (lower) ②.

Note:

- Lubricate the bolts ③ with grease.
- Be sure to position the bolts ③ so that the bolt head faces outward.
- Temporarily tighten the nuts ④.
- Install the front shock absorber ⑤.
- Install the ball joints.
- Install the new cotter pins.
- tighten the nuts ④.

Torque value:

- Nut ④ : 4.5 kgf-m
- Nut ⑥ : 4.5 kgf-m
- Nut ⑦ : 2.5 kgf-m
- Nut ⑧ : 4.8 kgf-m

15-10. Toe-In

When repair or disassemble steering system parts, must to adjustment the toe-in.

- refer to 2-20.
- Tighten the locknut (rod end): 1.5kgf-m. and mark them.
- After setting the toe-in to specification, run the machine slowly for some distance with both hands lightly holding the handlebar and check that the handlebar responds correctly. If not, turn either the right or left tie-rod within the toe-in specification.

Toe-in:

0~10mm (with tire touching ground)

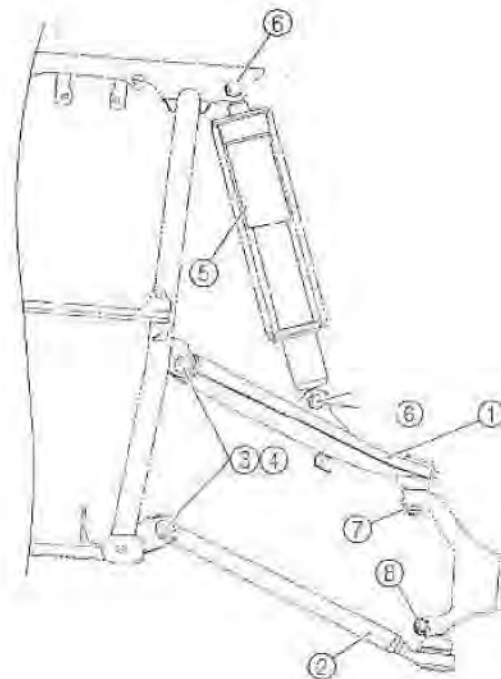



NOTE:

16-01. Mechanism Diagram.....

16-02. Maintenance Description.....

16-03. Trouble Diagnosis.....

16-04. Rear Wheel/Tire.....

16-05. Rear Wheel Rim, Knuckle and Drive axle

16-06. Rear Brake System Inspection.....

16-07. Adding Brake Fluid.....

16-08. Brake Fluid Replacement / Air-Bleed.....

16-09. Rear Brake Caliper.....

16-10. Rear Brake Disk.....

16-11. Rear Suspension ARM

16-12. Rear Brake Master Cylinder.....

16-13. Parking brake.....

16-01. Mechanism Diagram

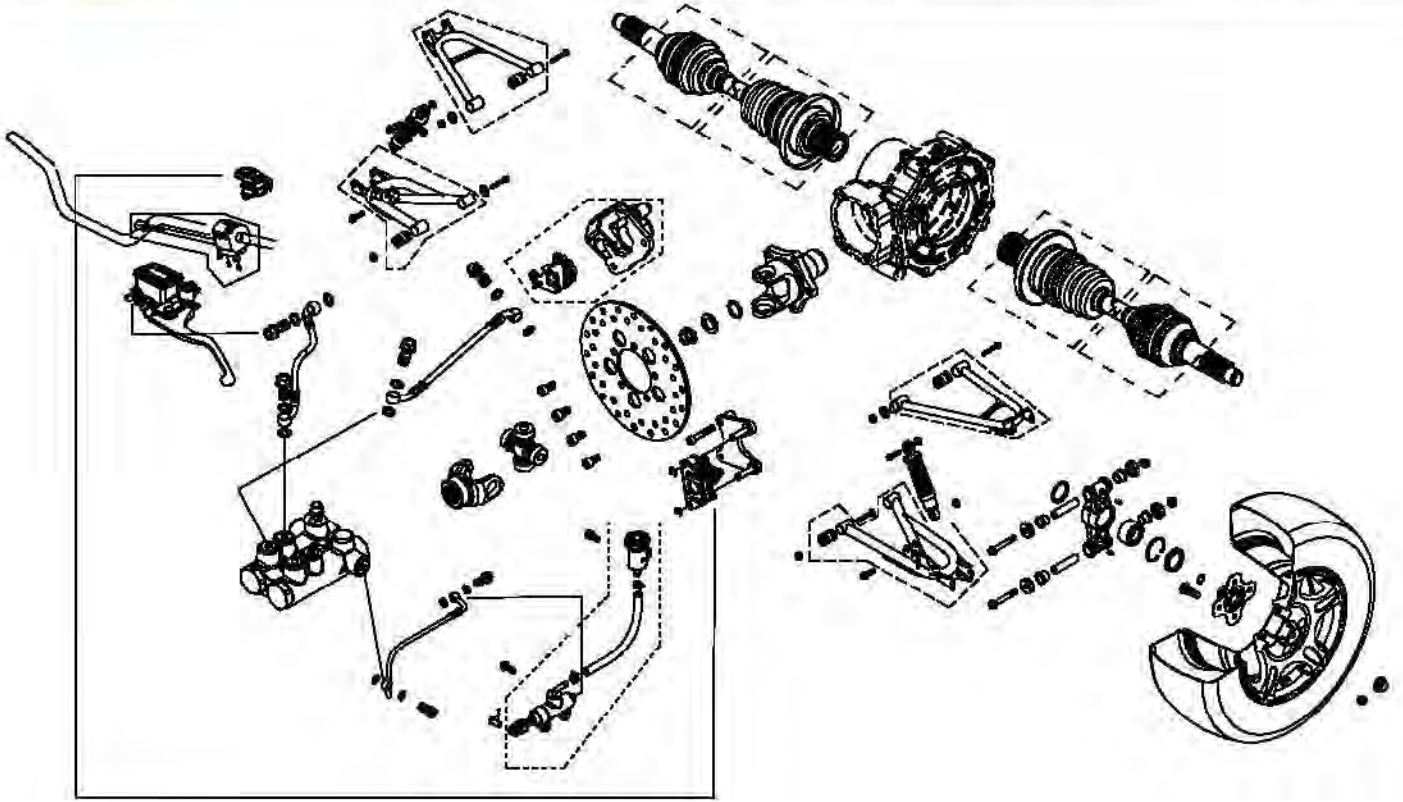

16-02. Maintenance Description

a. Operational precautions

Caution/Notice

1. Use vacuum cleaner or other authorized tool instead to clean the dust on brake disc and caliper.
2. The brake caliper can be removed without removing the hydraulic system.
3. After the hydraulic system is removed, or the brake system is felt to be too soft or sponge feel, bleed the hydraulic system.
4. While refilling brake fluid, care should be taken not to let the foreign material entering into the brake system.
5. Do not spill brake fluid on the painted surfaces, plastic or rubber parts to avoid damage. Check the operation of the brake system before each riding.
6. Please refer to the Maintenance Manual of tubeless tire in respect to the removal, repair and installation of the tire.

b. Specifications

Item	Standard (mm)	Limit (mm)
The thickness of front brake disk	3.5	3.0
The thickness rear brake disk	5.0	4.5
Front and rear brake disk eccentricity	< 0.1	0.3
Master cylinder inner diameter	14.000~14.043	14.055
Master cylinder piston outer diameter	13.957~13.984	13.945
Diameter of front disk	220	-
Diameter of rear disk	200	-
Thickness of brake lining	4.5	1.5

Tire pressure as cold : 8(7)psi (On-road)
5(3.5)psi (Off-road)

16-03. Trouble Diagnosis

a. Soft/sponge feel when apply the brake lever / brake paddle

- Air inside the hydraulic system
- Hydraulic system leaking
- Worn master piston
- Worn brake pad
- Poor brake caliper
- Worn brake lining/disk
- Low brake fluid
- Blocked brake hose
- Bent brake lever

b. Hard operation of brake lever

- Blocked brake system
- Poor brake caliper
- Blocked brake pipe
- Seized/worn master cylinder piston
- Bent brake lever

c. Uneven brake

- Dirty brake lining/disk
- Poor wheel alignment
- Clogged brake hose
- Deformed or warped brake disk
- Restricted brake hose and fittings

d. Tight brake

- Dirty brake lining/disk
- Poor wheel alignment
- Deformed or warped brake disk

e. Brake noise

- Dirty lining
- Deformed brake disk
- Poor brake caliper installation
- Imbalance brake disk or wheel

16-04. Rear Wheel/Tire

a. Removal

- Raise the rear wheels off ground by placing a jack or other support under the frame.
- Remove the four rear wheel lock nuts, and the remove rear wheel.

b. Inspection

- Check the wheel rim cracks, bends, damage → Replace a new
- Check the tire (refer to 14-04)

Note: Always balance the wheel when a tire or wheel has been changed or replaced.

c. Installation

- Install the rear wheel and tighten the lock nuts.
- Refer to 14-04

Torque for wheel lock nut M10: 5.5 kgf-m



16-05. Rear Hub, Knuckle and Drive

Axle

a. Remove

1. Remove the rear hub.

- Remove the flange nut (M20) from rear wheel hub, then pull out the LH/RH rear

2. Remove the rear wheel knuckle

- Remove the o-ring from LH/RH rear drive axle.
- Use wrench to hold the flange bolt (M10*95) head side, then loosen and remove the upper and lower fixing 2 flange bolts / Nuts on the rear wheel knuckle (R/L).
- Remove the thrust covers on the rear knuckle
- Remove the rear knuckle.

- ##### 3. Pull out the rear LH/RH drive axle from rear transmission gear box.

b. Inspection

1. Rear Hub – damage/cracks/ worn spindles
→ replace
2. Rear Knuckle
 - Oil seal – cracks/damage → replace
 - Bearing – roughness → replace (refer to 15-06)
 - Inner collar/bush/cir-clip/grease nipple
→ replace
3. Constant Velocity Joint
Excessive play → Replace the joint ass'y.
Refer to Chapter 17.
Recommended repairing boot:
42533-MAX-00 (Boot set)
42838-MAX-00 (Boot set)

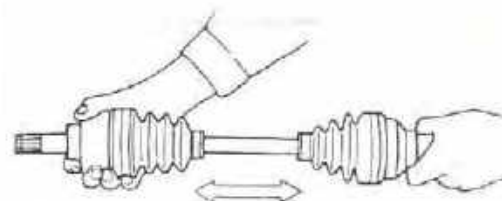
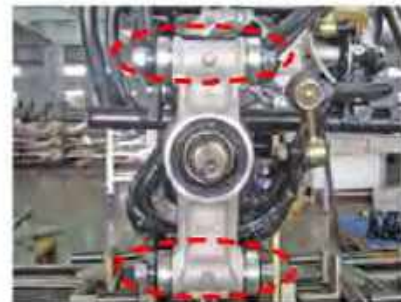

c. Installation

1. Install the LH / RH drive axles assy to the rear gear box.
2. Install rear wheel knuckle and tighten the flange nuts & bolts at upper and lower knuckle side.

Torque: 5.5 kgf-m

3. Insert the O-ring to the rear drive axle, then install rear wheel hub.
 - Add Loctite glue to the rear drive axle and flange nut, then stake collar of the nut into the notch of the shaft.
 - Always replace a new nut

Torque: 26 kgf-m

16-06. Rear Brake System Inspection

a. Inspection

- By visual examination whether fluid leaking or the damage on the brake hose side, the connecting bolts/washer side, and caliper body side.
- Turn the handle left and right, pressure to the rear shock, to check if there are any interferences, abnormal pull & push on the hose side.
- Check the brake from inside the brake caliper. The brake pad must be replaced with new lining when the brake pad wears to the service limit.
- Park the ATV on a plane ground, and check the master cylinder screen if fluid level is under the "LOWER" mark. If yes, check the brake system if any leaking, and add the sufficient brake oil into the master cylinder.

Recommended Brake Fluid:

Brake Fluid (DOT 4).

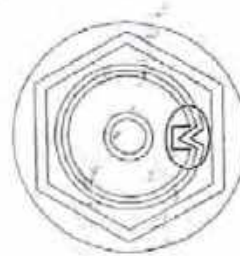

- Apply the brake lever on left hand side (rear brake & parking brake) and on the right foot pedal side, check the free play, brake power, if perform normal. Adjust the parking brake cables or do the air bleeding on the hydraulic brake system.
- Refer to 14-06.



16-07.Adding Brake Fluid

- Refer to 14-07.
- Before the brake fluid reservoir is removed, turn the handle so that the brake fluid reservoir becomes horizontal.
- Check the rear brake fluid reservoir tank on the front left master cylinder and right footrest side, if the brake fluid level is above the lower limit.
- If the brake fluid level is lower to the limit, remove the brake fluid cap and diaphragm and add the recommended brake fluid.



Clean the dirty brake disk

16-08. Brake Fluid Replacement / Air-bleed

- Refer to 14-08

Before Air bleeding on the hydraulic brake system, please apply the brake pedal, front and rear brake lever, to distinguish where the air bubble is located.

Do the air bleeding / brake fluid replacement process below when there is a sponge feel while apply the rear pedal or replace the new brake fluid.

a. Air bleeding on the brake shunt Assy side.

- Connect a transparent drain hose to air-bleed valve on the brake shunt, and place an oil container under the brake shunt to collect the exhaust brake fluid.
- Open the brake fluid reservoir cap at right footrest side, check and add the brake fluid while doing the below air bleeding process.
- Open the drain valve around 1/4 turns on the brake shunt and keep applying the brake pedal.
- Checks the drain hose for the air bubble flow while apply the brake pedal. Close the air bleeding bolt until there is no air bubble comes out/ brake fluid become clear (new)
- Apply the brake pedal to check if the brake feeling is firm and solid.
- Add brake fluid on rear brake fluid reservoir the level between upper and lower limit and closed the reservoir cap.

Recommended brake fluid:
DOT 4 brake fluid



b. Air bleeding on the rear brake caliper side.

- Refer to 14-08

Caution:

Before doing the rear caliper air bleeding, please make sure there is no air bubble between rear master cylinder to brake shunt side.

- Connect a transparent drain hose to air-bleed valve on the rear brake caliper, and place an oil container under the rear brake caliper to collect the exhaust brake fluid.
- Open the rear brake master cylinder cap at left handle bar side, check and add the brake fluid while doing the below air bleeding process.
- Open the drain valve around 1/4 turns on the rear brake caliper and keep applying the brake pedal.
- Check the drain hose for the air bubble flow while apply the brake lever. Close the air bleeding bolt until there is no air bubble comes out/ brake fluid become clear.
- Apply the brake lever to check if the brake feeling is firm and solid.
- Add brake fluid on rear brake master cylinder at the level between upper and lower limit and closed the reservoir cap.

Recommended brake fluid:
DOT 4 brake fluid

16-09. Rear Brake Caliper

- Refer to 14-09

Note:

It is unnecessary to remove the brake hose on the normal service work only if the rear caliper is defect.



a. Removal

1. Place a container under the rear caliper,
2. Loosen the fluid hose bolt on the caliper.
3. After brake fluid out completely, remove the brake hose union bolt, two copper washer and then finally remove the brake hose.

Caution

Do not spill brake fluid on painted surfaces.

4. Remove two caliper bracket bolts on the rear gear box side and remove the rear caliper(with bracket).

b. Inspection

Make sure the brake linings condition. Replace the linings if the brake linings wear limitation groove close to the brake disk.

c. Installation

- Install the brake caliper and tighten the attaching bolts securely.

Torque: 4.5 kg-m/45 Nm

Caution

1. Use M10 x 50 mm flange bolt only.
 2. Long bolt will impair the operation of brake disk.
- Use two seal copper washers and hose union bolts to lock the hose and brake caliper in place.

Torque: 4.5kg-m / 45Nm

- Refill up the brake fluid to the reservoir and make necessary air bleeding.



16-10. Rear Brake Disk

a. Removal

1. Stand the frame off the ground; remove the right and left side of rear wheel rim and footrest cover.
2. Remove the ANTI-ROLL BAR
 - Remove the right and left side of the fixing bolt of ball joint at the lower of suspension arm.
 - Remove the fixing bolt of the anti-roll bar holder and then remove the anti-roll bar.
3. Remove 2 bolts on rear gear box and remove the rear caliper with bracket.
4. Remove parking brake caliper
 1. Remove out the parking brake adjust nut and remove the parking brake cable from brake arm.
 2. Remove the 2 flange bolts on the parking brake caliper side and remove the parking brake caliper.
5. Remove 4 socket bolts and pull out the rear drive shaft



6. Use G-clamp to hold two side of needle bearing cap at rear brake disc side, add the pressure, remove the cir-clip on the cross joint side, then remove the universal joint (with cross joint on it)



7. Pull out the Remove the 4 socket bolt on the rear brake disc and remove the brake disc.

8. Inspection

- refer to 2-12/14-10
- Visually check the brake disk for wear or break.
- Measure the thickness of the disk at several places. Replace the disk if it has exceeded the service limit.

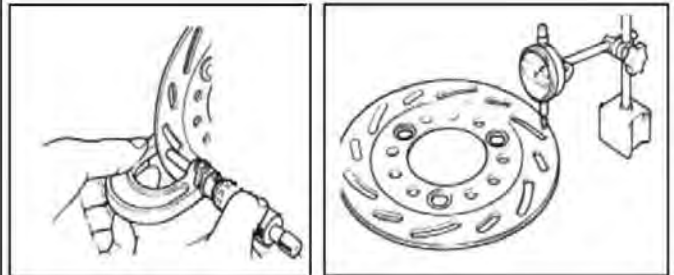

Allowable limit: 4.5 mm

- Check the disk for deformation and bend.

Allowable limit: 0.30 mm

Caution

1. The dirty brake lining or disk will reduce the brake performance.
2. Please do not use the air-gun to be clean, the operator should use vacuum cleaner to clean it.

- Check the universal joint at anti-roll bar, if any deform, rubber seal damage, oil leaking, un-smooth bearing operation. Replace with new if necessary.

- Check the anti-roller bar, holder and bush side, if any deform, damage, replace with new if necessary.



9. Installation

Do the reverse way of removal. Grease the bearing, oil seal on the rear propeller shaft before install.

Torque setting:

1. Install the rear brake disk and tighten the socket bolts (M8*17) refer to 14-05.

Torque: 3.5kg-m

2. Install the anti-roll bar and tighten the holder bolts (M8*12).

Torque: 3 kgf-m

3. Install the anti-roll bar universal joint to the rear lower suspension arm and tighten the flange nuts.

Torque: 4.8 kgf-m

4. Installation of parking brake caliper socket bolt(M8*45)

Torque: 3kgf-m

5. Installation of rear brake caliper bracket flange bolt (M10*50):

Torque:4.0kgf-m

6. Installation of the rear drive shaft the socket bolts (M8*17) with loctite glue.

Torque:4.0 kg-m

16-11. Rear Suspension ARM

a. Removal

1. Removal of rear shock absorber

- Shift the vehicle to let the vehicle off ground.
- Remove the rear wheel R/L
- Remove the lower and then upper fixing bolts and removes the rear shock absorber.



2. Remove the upper and lower rear suspension arm

- Remove the anti-roll bar, wheel hub, knuckle, rear axle, rear shock absorber as mentioned at previous section of Chapters.
- Remove 2 flange bolts (M10*70) and nuts (M10) on the upper suspension arm, then remove the upper suspension arm.
- Remove 2 flange bolts (M10*70) and flange nuts (M10) on the lower suspension arm, and then remove the lower suspension arm.
- Remove the thrust cover at rear side of upper & lower A-arm



b. Inspection

1. Rear shock absorber

- Check the absorber if any oil leaking, damage.
- Check the bushings on the two side of absorber, if any break, deform. Replace with new if necessary.

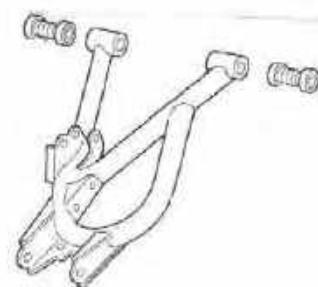

2. Upper and lower rear suspension arm

- Check the bushings at the frame installation side, if any break, damage,

replace with new if necessary.

- Check the suspension arm body, if any deforms, crack, wear, and replace with new if necessary.



c. Installation

- Put a thrust cover at rear side of A-arm, install the rear arm lower and tighten the flange bolt (M10*70) and flange nut (M10).

Torque: 4.5 kg-m /45 Nm



- Put a thrust cover at rear side of A-arm, install the rear arm upper and tighten the flange bolt (M10*70) and flange nut (M10).

Torque: 4.5 kg-m /45 Nm

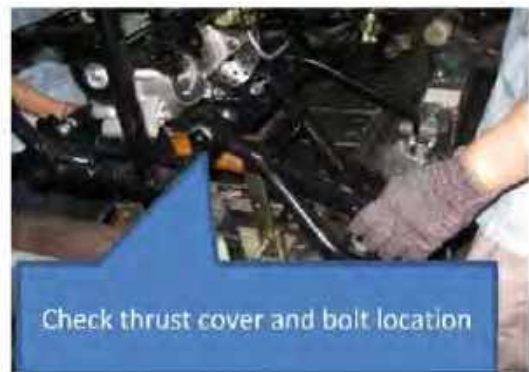

- Installation steps:

1. Install the rear arm (upper) ① and rear arm (lower) ②.
2. Lubricate the bolts ③ with grease.
3. Be sure to position the bolts ③ so that the bolt head faces outward.
4. Temporarily tighten the nuts ④.
5. Install the rear shock absorber ⑤ from top to lower.
6. Install the rear knuckle.
7. Tighten the nuts ④.

Torque value:

- Nut ④: 4.5kgf-m
- Nut ⑥ 4.5kgf-m
- Nut ⑦ 4.5kgf-m

- Install the anti-roll bar, wheel hub and wheel rim as mentioned at previous section of this Chapter.

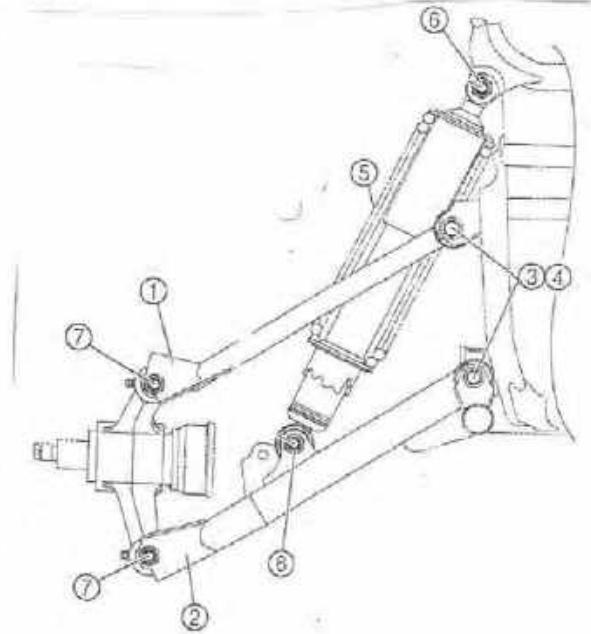

16-12. Rear Brake Master Cylinder

a. Master Cylinder Removal

Caution

The whole set of master cylinder, piston, spring, diaphragm and cir-clip should be replaced as a set.

1. Handle left side – rear brake master cylinder

- Remove brake light switch coupler.
- Loose the brake fluid hose bolt on the left master cylinder side, drain out the brake fluid.
- Remove the brake hose.
- Remove the brake lever pivot bolt, and remove the brake lever from the brake master cylinder.
- Remove the master cylinder socket bolts and the master cylinder.



2. Right footrest side – rear brake master cylinder

- Place a container under the brake master cylinder, remove fluid hose clamp, and drain out the brake fluid.
- Loosen the brake hose bolt and finally remove the brake hose.
- Remove the cotter pin from clevis pin in connecting with brake pedal and rear master cylinder, then remove the clevis pin.
- Remove the master cylinder 2 flange bolts and then remove the rear master cylinder.

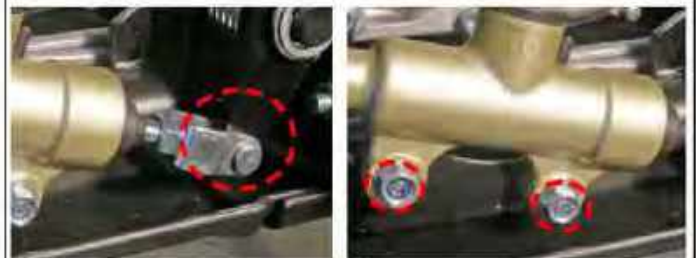

b. Master Cylinder Inspection

- Check the master cylinder for damage or scratch. Replace it if necessary.
- Do not suggest to disassemble the brake related components (ex. master cylinder/caliper/shunt).

c. Master Cylinder Install

Caution

Improper routing may damage leads, hoses or pipes.

Caution

Wrong brake leads, hose or pipe may reduce brake performance.

1. Handle left side – rear brake master cylinder
 - Install the master cylinder onto handlebar, and install the bolts.
 - Install the brake lever, and connect the brake light switch.
 - Connect brake hoses with 2 new washers; tighten the brake hose bolt to the specified torque value.

Torque: 3.0 kg-m / 30 Nm

- Make sure the hose is installed correctly.
- Add specified brake fluid and bleed the system.

2. Right footrest side – rear brake master cylinder

- Install the master cylinder bolts and the master cylinder.
- Install brake push rod to the brake pedal, and install cotter pin onto clevis pin.
- Connect brake hoses with 2 new washers. Tighten the brake hose bolt to the specified torque.

Torque: 3.0 kg-m/ 30 N-m

- Install the fluid reservoir hose to rear master cylinder, and tighten with hose clamp. Make sure the hose is installed correctly.
- Add specified brake fluid and bleed the system.
- Adjust the brake pedal with correct free play setting. Loosen lock nut, and turn adjustment nut and apply brake pedal to adjust brake free play.

Suggest Free play: 2~4mm

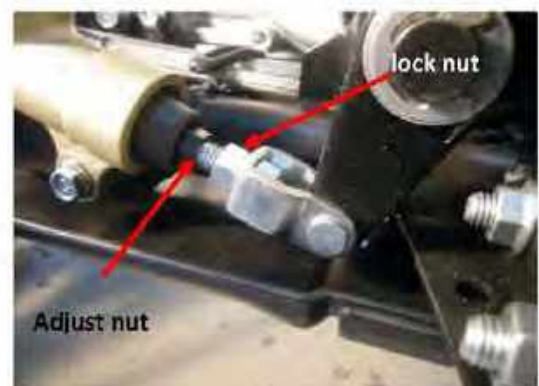
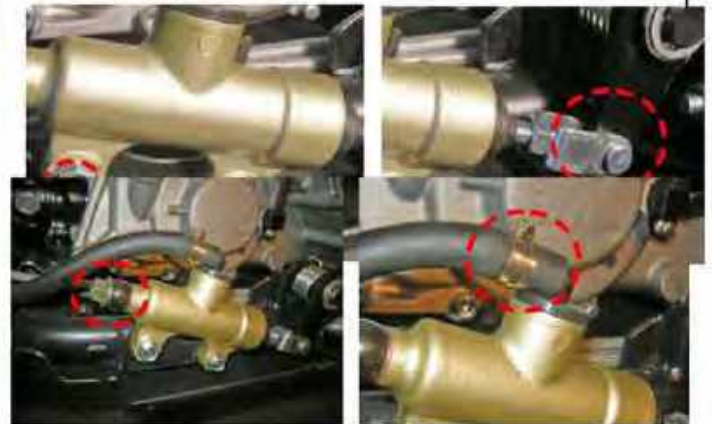

16-12. Parking brake

a. Removal of caliper ass'y

1. Release the cable on the handle-bar and the two nuts of cable and remove the cable from caliper holder.
2. Turn the disk to find the hole for inside bolts.
3. Unscrew the two bolts M8*28
4. Remove the whole set of caliper ass'y from rear disk and rear gear box.



b. Inspection

Do not disassemble the caliper ass'y without special training. Suggest to replace the whole caliper.

1. Check crash/damage => replaced
2. Wear of pads => always replace a pair of pad
3. Boot crash => replaced



c. Installation

Do the reverse way of removal.

- M8*28 bolt fix
Torque: 3.3 kg-m / 33 Nm
- Grease the cable and adjust cable properly and test the parking brake.





NOTE:

17-01. Mechanism Diagram
17-02. Trouble Diagnosis
17-03. Wheel Drive Shaft Removal
17-04. Wheel Drive Shaft Disassembly
17-05. Wheel Drive Shaft Inspection
17-06. Repair Pack
17-07. Wheel Drive Shaft Assembly
17-08. Front and Rear Propeller Shaft

17-01. Mechanism Diagram

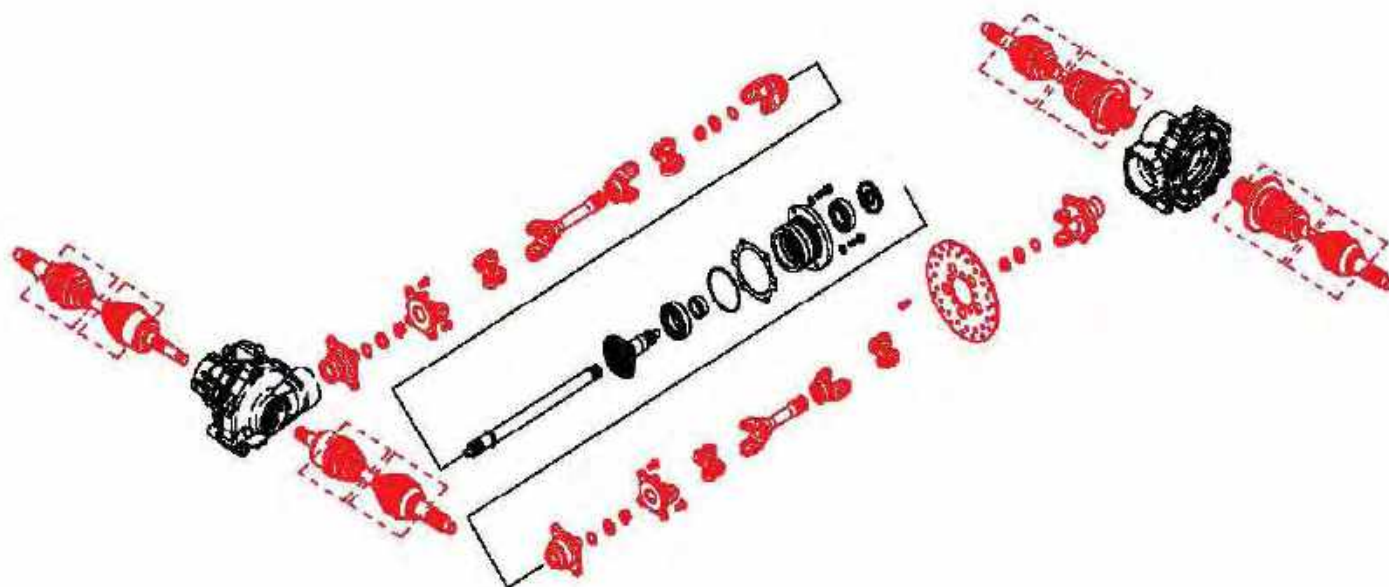

17-02. Trouble Diagnosis

a. Engine can be started but vehicle cannot move.

- Damaged wheel drive shaft
- Damaged propeller shaft
- Damaged front differential or rear gear box

b. Noise

- Worn or burnt drive shaft
- Worn or burnt steel ball
- Worn or burnt gear

c. Gear oil leaks

- Excessive gear oil
- Worn or damaged rubber boot
- Worn or damage oil seal

17-03. Wheel Drive Shaft Removal

a. Front wheel drive shaft removal

- Remove the front right / rear wheel.
- Remove the front right / rear brake caliper ,disk and wheel hub..

- Remove the cotter pin, castle nuts, and then remove the tie-rod and steering knuckle.

- Remove the front right / left wheel drive axle



b. Rear wheel drive axle removal

- Remove the rear right / left wheel.
- Remove the rear right / left wheel hub.
- Remove the right / left wheel knuckle
- Remove the rear right / left wheel drive shaft.

17-04. Wheel Drive Axle Disassembly

a. Universal joint disassembly

- Open the boot band clip with scrapper.
- Remove the rubber boot bands.
- Remove the UJ rubber boot.
- Disassemble the wheel drive shaft UJ assembly with rubber hammer & special tool.

Caution

Do not disassemble UJ assembly by using the steel hammer.

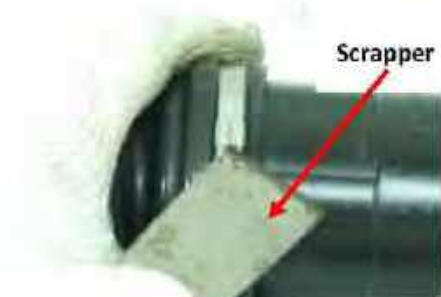

- Remove 6 steel balls from UJ assembly outer race.

- Remove the inner race and cage from the outer race.

- Clean the inner race, outer race, steel balls and cage.



b. Double Offset Joint Disassembly

- Open DOJ band clip with scrapper.
- Remove the wheel drive shaft boot band.
- Remove the DOJ rubber boot.

- Remove the inner cir-clip with screw drive.



- Disassemble DOJ assembly.



- Clean the DOJ assembly.
- Remove the cir-clip from the drive shaft.



- Remove the steel balls from cage.



17-05. Wheel Drive Axle Inspection

- a. Clean all spare parts. Check the surface of these parts for wear or scratch. Replace DOJ or UJ assembly if any stepped scratch is found.

- b. Check the inside surface of UJ outer race. Replace UJ assembly if it is damaged.

- c. Check the inside surface of DOJ assembly outer race. Replace double offset joint assembly if it is damaged.



17-06. Repair Pack

a. Check if DOJ & UJ boot is damaged. Replace DOJ or UJ assembly if it is damaged.



b. Remove the DOJ & UJ boot band.



c. Remove the DOJ & UJ cage.



d. Remove the DOJ & UJ boot.



e. Disassemble and clean all spare parts. Check if there is any corrosion on the surface of these parts. Replace DOJ or UJ assembly if any damaged part is found.



f. Clean the DOJ & UJ cage.



g. Unpack DOJ Repair Pack.

- Front: 42538-MAX-00
- Rear: 42838-MAX-00



h. Unpack UJ Repair Pack.

- Front: 42533-MAX-00
- Rear: 42533-MAX-00



17-07.Wheel Drive axle Assembly

a. DOJ assembly

- Assemble the DOJ boot.

- Assemble 6 steel balls, inner race and cage then drive shaft into the assembly.

- Assemble exit cir-clip onto drive shaft.

- Grease into the DOJ outer race.

Caution

Please use the grease of the repair pack. Using other oil may cause the part to be damaged.



- Install the wheel drive shaft and cir-clip into DOJ outer race.

- Install DOJ boot outside band.

- Install DOJ boot.

Pull and open DOJ boot Pressure balancing that make it inside and external.

- Deduct DOJ band closely with rubber hammer.



Large band



b. assembly

- Assemble universal joint and UJ boot and Pour into the grease.

- Pour grease into the UJ boot inside.

Caution

Please use the grease of the repair pack. Using other oil may cause the part to be damaged.

- Assemble cir-clip with the tool.
- Strike the wheel drive shaft by rubber hammer.



- Install UJ boot.
- Pull and open DOJ boot to balance the inside and outside pressure.
- Install band with rubber hammer.



17-08. Front and Rear Drive Shaft

a. Rear Drive Shaft Remove

- Loosen 4 bolts from the rear drive shaft connector.(rear coupling)

- Pull out and remove the universal joint, cross joint and rear drive shaft



b. Remove of front propeller shaft assy.

- Loosen and remove 4 socket bolts from the front drive shaft connector.(front coupling)

- Pull out and remove the universal joint, cross joint and front drive shaft



c. Disassembly of the Front/Rear propeller shaft assy (universal joint and cross joint)

- Use the G-clamp to push two side of the cross joint cap and remove the fixing cir-clip.

- Remove the Cap of the cross joint.
(apply to all the universal joint dis-assembly of front and rear propeller shafts)



d. Inspection of the front and rear propeller shafts, universal joints, cross joints

- Clean all the parts.
- Check all couplings for wear or scratch, damage → Replace with new if necessary.
- Check spindles/ threads of couplings for wear/scratch/damage → Replace

- Turn the cross joint cap, check if smoothly (check the condition of inside needle bearing if normal)

- Check needle bearing , fixing C-clips on the cross joint. Replace with new one if wear/damage
 - Always replace the cross joint, needle bearings, (joint cap), C-clips as a set.

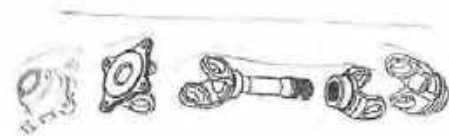

e. Assembly of the universal joint/cross joint

- Grease the needle bearing inside the cap.
 - Lithium soap base grease.

- Install one side of cap to the cross joint through the universal joint hole, and close it by fixing cir-clip.
 - Always replace a new cir-clip.

- Put another side of the cap onto cross joint through opposite side the universal joint.

- Put the G-clamp to push the two edges of the cross joint cap, and install the fixing cir-clip.



- Turn the cross joint, and check if bearing, oil seal function well.

- Follow above, to install another universal joint on the same cross joint.

- f. Install the front / rear drive/driven shafts.**
- Grease the shaft gear before install the propeller shaft to the universal joint.



- Follow reverse process of removal to install the front / rear propeller shaft.

Torque of the drive shaft connecting socket bolt: 4kgf-m

NOTE:

18-01. Mechanism Diagram.....
18-02. Trouble Diagnosis.....
18-03. Rear Gear Box
18-04. Front Differential Gear Box.....

18-01. Mechanism Diagram

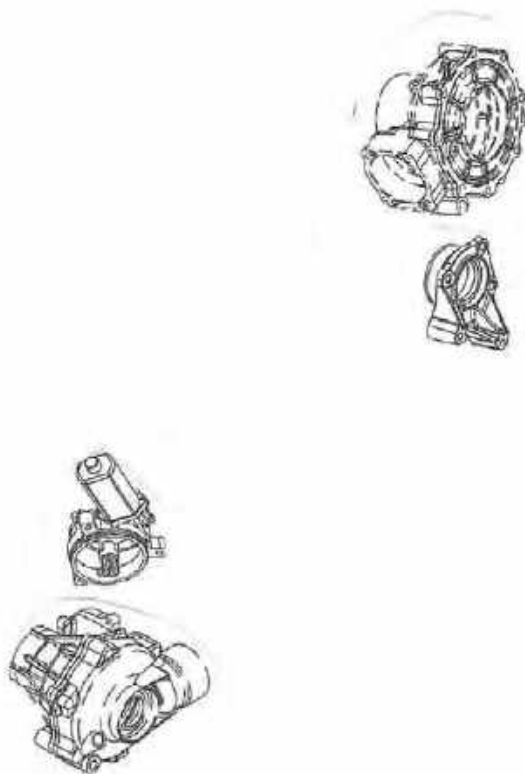

18-02. Trouble Diagnosis

a. Engine can be started but vehicle cannot move.

- Disconnect couplings
- Damaged propeller shaft
- Damaged front differential or rear gear box

b. Noise

- Worn or burnt driving/drive pinion gear
- Bearing damage
- Gear tooth damage
- Shims adjusting
- Not correct engagement on gears
- Less gear oil/ not correct gear oil/ no oil replacement
- Improper gear backlash

c. Gear oil leaks

- Excessive gear oil
- Worn or damage oil seal/o-ring
- Damage on the gear box.

18-03. Rear Gear Box

a. Rear gear box removal

Refer to 17-08 to disconnect/install the couplings with engine.
Clean gear box before removing.

Clean gear box before removing.

- Drain out the gear oil by loosening drain bolt under the gear box.
- Unscrew two bolts to remove rear caliper.
- Unscrew two bolts and remove bolts/washers/nuts.
 - Loosen all bolts in stages, then remove.
- Release the breath pipe/park cable and remove the rear gear box out.
 - suggest to remove gear box as a whole set with disc and park caliper.



b. Inspect

- Lash adjustment have been done inside the gear box. Do not suggest to open the gear box without experience.
- Adjusted shims remarked the "grade" in the case of gear box.
- Check the oil seals/o-ring damaged → replace
- Check bearings damaged → replace
- Check bevel gears damaged → replace
- Check the breath hose pipe broken/crack/damaged → replace



c. Gear box installation

- Assemble gear box sets as reverse steps.
- Ensure to follow specific torque

Torque value:

M10 Nut for Gear box: 8kgf-m

M10*50 bolt for caliper: 4kgf-m

- Ensure breath hose pipe fixing to the upper chassis pipe.
- Install back the drain bolt (& drive rear axles) then refill gear box oil then fix filler bolt.
 - replace a new washer
 - apply enough grease on oil seals/drive shaft/axles.
 - gear oil (refer to 2-19)

Periodic oil change: 290cc

Oil change after disassembling: 330cc

Recommended oil: SAE 90 API "GL-4" Hypoid gear oil.

- Torque value:
 - M12 drain bolt: 2.6kgf-m
 - M16 filler bolt: 2.6kgf-m



18-04. Front Differential Gear Box

a. Rear gear box removal

Refer to 17-08 to disconnect/install the couplings with engine.

Clean gear box before removing.

- Drain out the gear oil by loosening drain bolt under the gear box.
- Unscrew three bolts and remove nuts/washers. differential gear box..
 - Loosen the all bolts in stage, then remove them.
- Release the breath pipe/ wire harness and remove the front differential gear box out.
 - Be careful to disconnect the coupling.
 - Remove differential gear box with gear motor and driven shaft as a set.



b. Inspection

- Never dismantle gear motor ass'y, replace it as whole component, if necessary.
- Lash adjustment have been done inside the differential gear box. Do not suggest to open the differential gear box without experience.

- Adjusted shims remarked the "grade" in the case of differential gear box.
- Check bearings damaged → replace
- Check bevel gears damaged → replace
- Check the breath hose pipe broken/crack/damaged → replace



c. Differential Gear Box Installation

- Assemble front differential gear box sets as reverse steps.
 - tighten the bolts in stages, and torque the bolts as:

Toque value:

M10 Nut : 5.5kgf-m

M10*30 bolt: 5.5kgf-m



- apply loctite glue to M10*30 blot
- Put the gear box from left side of chassis and be careful to the gear motor and connect the drive shaft to the engine.

- Install back the drain bolt (& drive rear axles) then refill gear box oil then fix filler bolt.
 - replace a new washer
 - apply enough grease on oil seals/drive shaft/axles.
 - gear oil (refer to 2-19)

Periodic oil change: 290cc

Oil change after disassembling: 330cc

Recommended oil: SAE 90 API "GL-4" Hypoid gear oil.

- **Torque value:**



M12 drain bolt: 2.6kgf-m
M16 filler bolt: 2.6kgf-m



- Ensure breath hose pipe to follow the chassis pipe

breath hose pipe

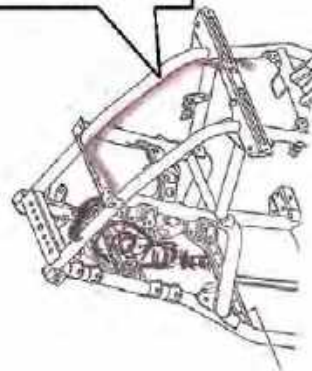

- Connect wire harness of gear motor.

NOTE:

- 19-01. Mechanism Diagram.....
- 19-02. Introduction
- 19-03. Chart
- 19-04. OBD
- 19-05. ECM
- 19-06. Injector / Intake
- 19-07. Throttle Body
- 19-08. Fuel Pump ass'y / Fuel tank
- 19-09. Fuel delivery hose.....
- 19-10. Oxygen sensor / Exhaust-pipe
- 19-11. Ignition Coil
- 19-12. Engine Temperature sensor / Cylinder head
- 19-13. Gear position switch.....
- 19-14. Crank Position sensor/ Generator ass'y
- 19-15. Relays control
- 19-16. Speedometer
- 19-17. Lean switch
- 19-18. Fault code

19-01 Mechanism Diagram





19-02. Introduction

How Electronic Fuel Injection Works

Electronic Fuel injection works on the some very basic principles. The following discussion broadly outlines how a basic **Electronic Fuel Injection (EFI)** system operates.

The Electronic Fuel Injection system can be divided into three basic sub-systems. These are the fuel delivery system, air induction system, and the electronic control system.

The Fuel Delivery System

- the fuel delivery system consists of the fuel tank, fuel pump, fuel filter, fuel delivery pipe, fuel injector and VSR.
- Fuel is delivered from the tank to the injector by means of an electric fuel pump. The pump is located in the top of fuel tank. Contaminants are filtered out by a high capacity in line fuel filter.
- Fuel is maintained at a constant pressure by means of a VSR in fuel pump assembly. Any fuel which is not delivered to the intake manifold by the injector is returned to the tank through a fuel return function.

The Air Induction System

- The air induction system consists of the air cleaner, throttle body and intake manifold.
- When the throttle valve is opened, air flows through the air cleaner, past the throttle valve to intake manifold.
- Air delivered to the engine is a function of rider demand. As the throttle valve is opened further, more air is allowed to enter the engine cylinder.
- The EFI system measures air flow indirectly by monitoring the pressure in the intake manifold.

Electronic Control System

- The electronic control system consists of various engine sensors, Electronic Control Module (ECM), fuel injector assemblies, and related wiring.
- The ECM determines precisely how much fuel needs to be delivered by the injector by monitoring the engine sensors.
- The ECM turns the injector on for a precise amount of time, referred to as injection pulse width or injection duration, to deliver the proper air/fuel ratio to the engine.

Basic System Operation

- Air enters the engine through the air induction system where it is measured by ECM. As the air follows into the cylinder, fuel is mixed into the air by the fuel injector.
- Fuel injectors are arranged in the intake manifold. The injectors are electrical solenoids which are operated by the ECM.
- The ECM pulses the injector by switching the injector ground circuit on and off.
- When the injector is turned on, it opens, spraying atomized fuel.
- As fuel is sprayed into the intake airstream, it mixes with the incoming air and vaporizes due to the low pressures in the intake manifold. The ECM signals the injector to deliver just enough fuel to achieve an ideal air/fuel ratio, often referred to as stoichiometry.
- The precise amount of fuel delivered to the engine in a function of ECM control.
- The ECM determines the basic injection quantity based upon measured intake air volume and engine rpm.
- Depending on engine operating conditions, injection quantity will vary. The ECM monitors variables such as coolant temperature, engine speed, throttle angle, and exhaust oxygen content and makes injection corrections which determine final injection quantity.

Advantages of EFI

Uniform Air/Fuel Mixtures Distribution

Cylinder has its own injector which delivers fuel directly to the intake. This eliminates the need for fuel to travel through the intake manifold, improving cylinder to cylinder distribution.

Highly Accurate Air/Fuel Ratio Control Throughout All Engine Operating Conditions

EFI supplies a continuously accurate air/fuel ratio to the engine no matter what operating conditions are encountered. This provides better drive ability, fuel economy, and emissions control.

Superior Throttle Response and Power

By delivering fuel directly at the back of intake, the intake manifold design can be optimized to improve air velocity at the intake. This improves torque and throttle response.

Excellent fuel Economy With Improved Emissions Control

Cold engine and wide open throttle enrichment can be reduced with an EFI engine because fuel puddling in the intake manifold is not a problem. This results in better overall fuel economy and improved emissions control.

Improved Cold Engine Start-ability and Operation

The combination of better fuel atomization and injection directly at the intake improves ability to

start and run a cold engine.

Simpler Mechanics, Reduced Adjustment Sensitivity

The EFI system does not rely on any major adjustments for cold enrichment or fuel metering. Because the system is mechanically simple, maintenance requirements are reduced.

Self Diagnosis System

A self diagnosis system is incorporated into all ECM in order to ensure that fuel injection system is operating normally. If this function detects a malfunction in the system, it immediately operates the engine under substitute characteristics and illuminates the engine trouble warning light to alert the rider that a malfunction has occurred in the system. Once a malfunction has been detected, a fault code is stored in the memory of the ECM.

19-03. Chart

- Pre-delivery Inspection flow chart

Checking engine no. & frame no.



Refuel Gasoline & install battery (+/-) as picture

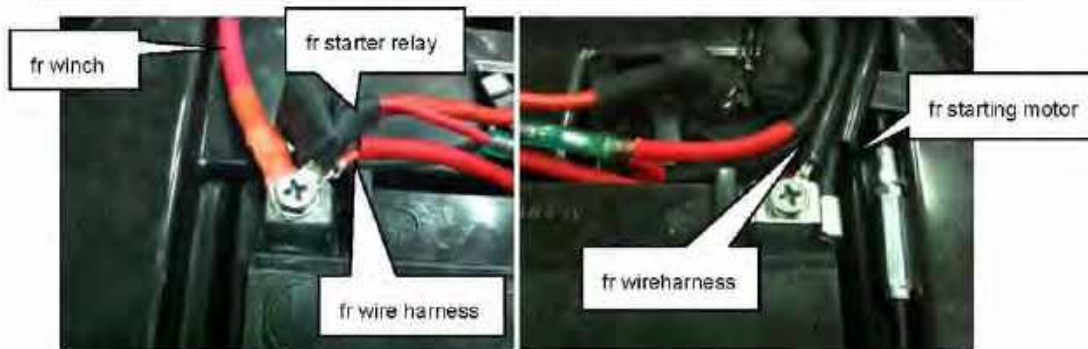



Inspect injector correctly installed

- a. if lean → correct it
- b. if with clearance → correct it



vertical to intake base without
clearance



Turn on main switch → check fuel pump function

- => turn on main switch => doesn't get any response from fuel pump => check related circuit (ex. connection loose, relay function, fuseetc) => to get fuel pump working
- => fuel pump working => to hear the pumping sound from fuel pump lasting for more than 2~3 seconds => if not, replace ECM => retry it to get correct function



Start engine

- => can't start engine => connect OBD to inspect the troublesome issues (Note 1) => correct it and retry it

↓ engine starting

Check speedometer the " check engine warning lamp" extinguish

- => "check engine warning lamp" still bright => connect OBD to inspect the troublesome issue (Note 1) => correct it and retry it.

↓ "check engine warning lamp" extinguish

Finish

Note 1:

Exclude troublesome issue

“check engine warming lamp” still bright



Connect OBD to read fault codes



Inspect TPS AD on 8500~13000

=> if not in the range => adjust it (Remark 1) to be in the range



Inspect TPS position $\leq 0.3\%$

=> if not => check the throttle cable or throttle body function => adjust it to be correct

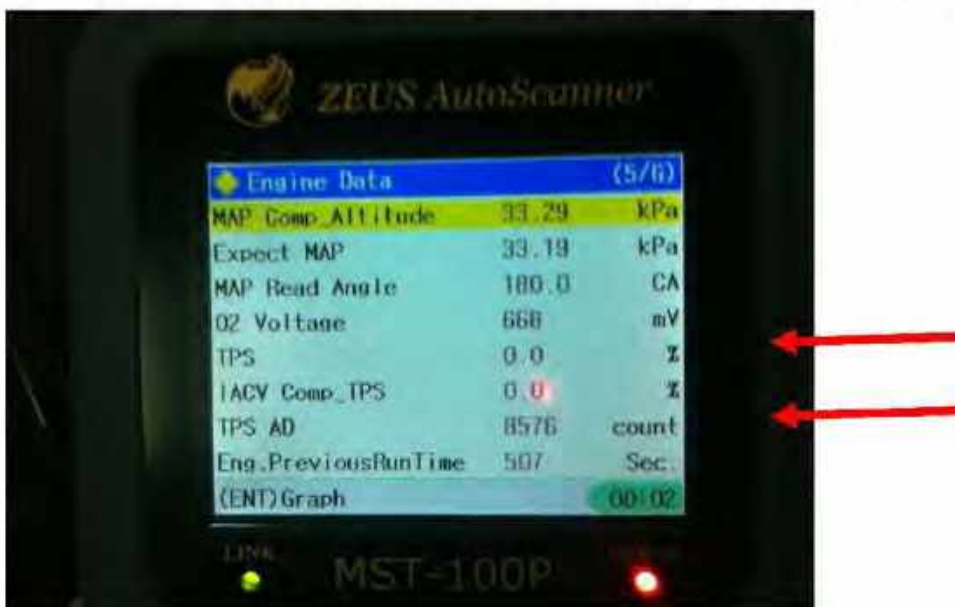

Start engine and run for 5 seconds



Turn off main switch for 15 seconds at least then re-start engine

=> 15 seconds is for ECM self-diagnosed

↓ engine starting and running

The engine running in with choke function (rpm raise to 2000~2200 in cold starting and 1700~1900 in hot starting) and go down to be idle quickly

=> without choke function => check TPS AD => not in the range (8500~13000) => adjust TPS AD (Note 2) to be in the range

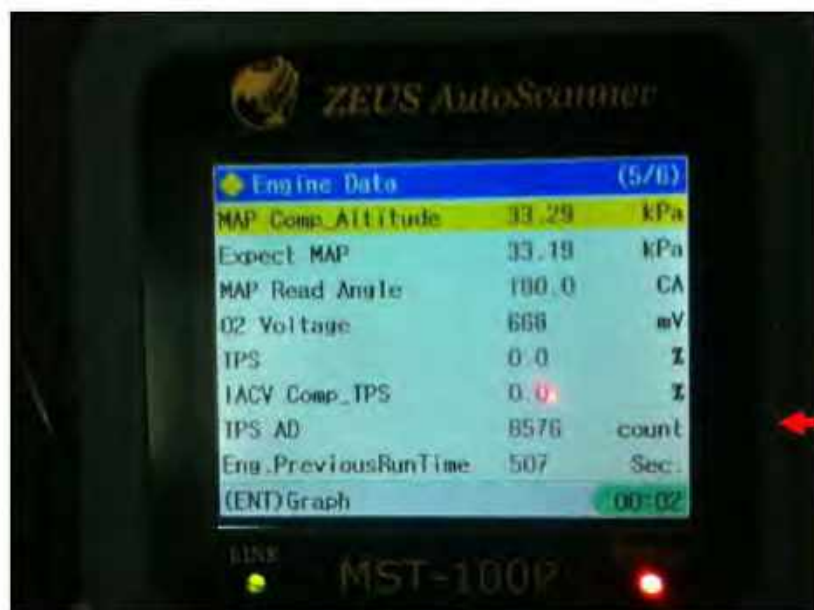

Check Idle speed in a stable rpm (1600±100)

=> unstable => check and adjust a) TPS in the correct range b) Desired Motor Step (Remark 4) to be proper range

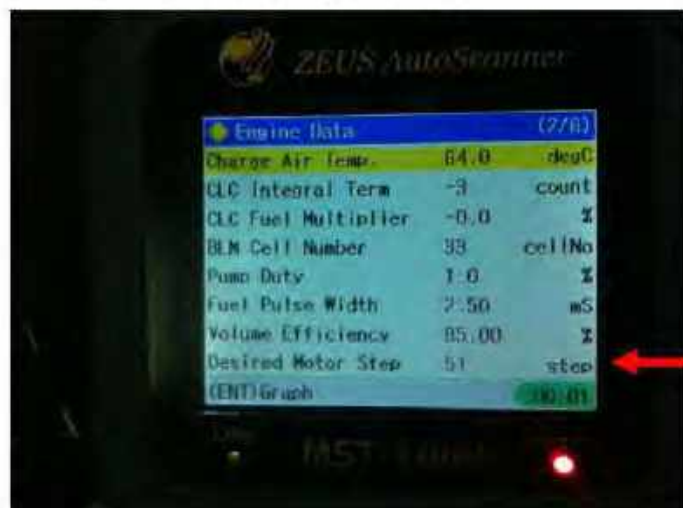



Turn lens switch over 65° to check it's function => engine cut off in 3 seconds

=> NG => replace lens switch



Switch off main switch and re-start engine

↓ engine running

coolant temperature reaches 80° => inspect air induction effectiveness →

a) BLM multiplier b) MAP multiplier => allowance in 0.8~1.2

=> inspect desired motor step



=> if BLM & MAP multiplier allowance not in 0.8~1.2 → it might be in air leaking condition, check air induction system (air cleaner, TB, intake.....) => correct it





Execute other final inspection steps

=>adjust or correct it



Finish

Remark 1

At once replacing or adjusting EFI parts, please always do the following to ECM self-diagnosis, it can improve the effectiveness of engine running.

=> restart engine and switch off engine running for more than 15 seconds and restart engine

Remark 2

Desired motor step built-in 30~40 steps at coolant temperature 80°, but it's not absolute. In normal, it also runs well during 20~60 steps. If the steps lower than 10 or higher than 80, the idle speed maybe in unstable condition → adjust idle screw (Remark 3) on TB to get the proper steps as built-in and recheck the TPS AD or to replace whole throttle body (TB).

Remark 3

Adjustment on idle screw

In engine running, do the followings

- 1) loosen the fixing nut
- 2) adjust the idle screw (a little a little each)
- 3) fix the fixing nut again
- 4) switch off engine for 15 seconds then restart engine



Remark 4

TPS AD value adjustment => switch off engine for 15 seconds and restart engine



loosen this two screws on TPS, and turn to left or right a little to check the variable from OBD.

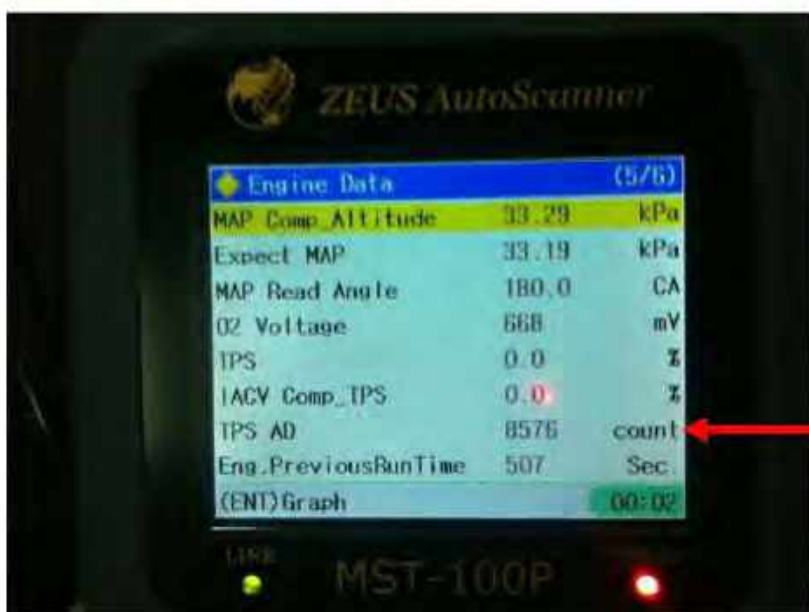

range in 8500~13000

Remark 5
Fault code table

Fault code(OBD)	Messages on fault code	Fault code(DEL)
P0107	MAP Circuit Low Voltage or Open	263
P0108	MAP Circuit High Voltage	264
P0112	IAT Circuit Low Voltage	274
P0113	IAT Circuit High Voltage or Open	275
P0117	Coolant/Oil Temperature Sensor Circuit Low Voltage	279
P0118	Coolant/Oil Temperature Sensor Circuit High Voltage or Open	280
P0122	TPS Circuit Low Voltage or Open	290



P0123	TPS Circuit High Voltage	291
P0131	O2S 1 Circuit Low Voltage	305
P0132	O2S 1 Circuit High Voltage	306
P0031	O2S Heater Circuit High Voltage	49
P0032	O2S Heater Circuit Low Voltage	50
P0201	Injector 1 Circuit Malfunction	513
P0202	Injector 2 Circuit Malfunction	514
P0230	FPR Coil Circuit Low Voltage or Open	560
P0232	FPR Coil Circuit High Voltage	562
P0336	CKP (crankshaft position)Sensor Noisy Signal	822
P0337	CKP Sensor No Signal	823
P0351	Cylinder 1 Ignition Coil Malfunction	849
P0352	Cylinder 2 Ignition Coil Malfunction	850
P0505	Idle Speed Control Error	1285
P0562	System Voltage Low	1378
P0563	System Voltage High	1379
P0650	MIL (malfunction indicator lamp) Circuit Malfunction	1616
P1693	Tachometer Circuit Low Voltage	5779
P1694	Tachometer Circuit High Voltage	5780
P0137	O2S 2 Circuit Low Voltage	311
P0138	O2S 2 Circuit High Voltage	312
P0038	O2S Heater 2 Circuit High Voltage	56
P0037	O2S Heater 2 Circuit Low Voltage	55
P0500	VSS No Signal	1280
P0850	Park Neutral Switch Error	2128
P0445	CCP short to high	1093
P0444	CCP short to low/open	1092
P0171	BLM Max Adapt	369
P0172	BLM Min Adapt	370
P0174	PE syst Lean	372

a. Exclude the troublesome and "check engine warning lamp" is still "ON" → it may erase fault code in ECM by manual (b.) → restart engine and check engine

b. Erase fault code by manual

- 1) to switch off engine by key for 15 seconds
- 2) to switch on/switch off 5 times within 5 seconds
- 3) to switch on again to be "RESET"

● **Terminal Alignment of ECM coupler**

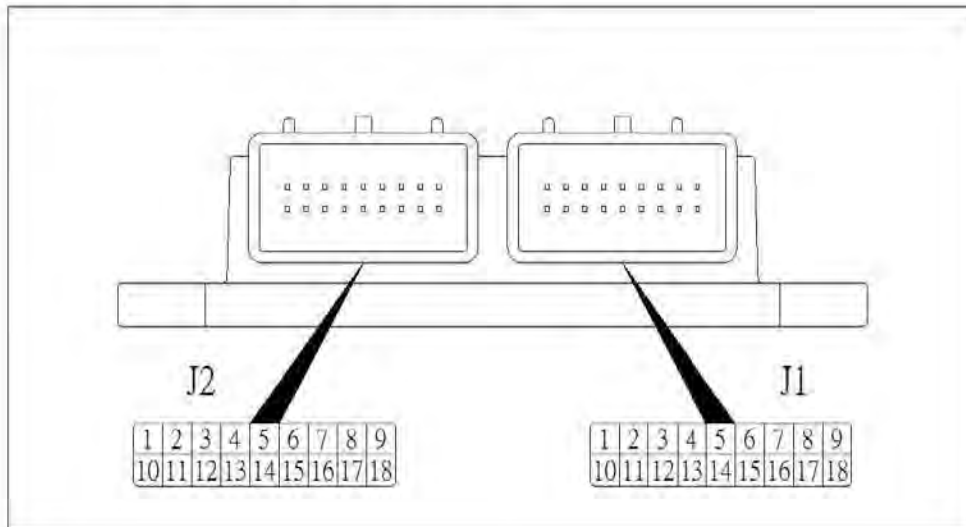

Terminal Names

J1	J2
1.Idle Air Control Valve(IACV) A High	1.Ignition Coil Signal A
2.Unused	2. Ground
3.Fault light	3.KW2000 (vehicle on-road diagnosis sys
4. Unused	4.Crankshaft Sensor Signal High
5. Unused	5.Injector Signal A
6.Tachometer	6. Unused
7.Communication Line Low	7.O2 Sensor Heating
8.Communication Line High	8.Inlet Air Temperature signal
9.Ground	9.Fuel Pump Relay Signal
10. Unused	10. 5V Reference Voltage Ground
11.Idle Air Control Valve(IACV) A Low	11.Inlet Air Pressure Sensor Signal
12. Idle Air Control Valve(IACV) B High	12.Throttle Position Signal
13. Idle Air Control Valve(IACV) B Low	13.Crankshaft Sensor Signal Low
14. Error Inspection Signal	14.Water Temperature Sensor Signal



15. Vehicle speed sensor	15. Ignition Power
16. 2WD/4WD Shift Switch Signal 2WD/4WD	16. 5V Reference voltage
17. Unused	17. O ₂ Sensor Signal
18. Reverse Switch Signal	18. Battery Power

19-04. OBD (On-Board Diagnostic)

a. OBD provided

SMC provides a special OBD to diagnosis the any troublesome in EFI system.

- Remove the front panel and find the coupler of diagnostic.
- Remove the protection cap
- Connect the OBD to diagnosis functions.
- Turn on switch to run OBD.
- Store OBD in box always and keep it dry.



19-05. ECM

In briefly, ECM is a unit collecting all working messages from engine and vehicle running. ECM works under pre-setup standardized elements by injector, IACV, fuel pump, ignition ...to mission activities in a optimum condtion.

The ECM is equipped with a self-diagnostic function in order to ensure that fuel injection system is operating normally. If this function detects a malfunction in the system, it



immediately operates the engine under substitute characteristics and illuminated the engine trouble warning light in speedometer to alert the rider that a malfunction has occurred in the system. Once a malfunction has been detected, a fault code is stored in the memory of the ECM.

- Terminal Alignment of ECM coupler (refer to 19-03)
- Plug-in and out ECM
 - Only plug in and out in switch off
 - Always hold the unit to plug-in or out the couplers
 - To less to plug in and out as possible as you can
 - Correctly install two couplers
- Working and Storing
 - ECM works in temperatures range -20°C ~ 80°C
 - Keep it in a clean, dry and ventilation
 - Keep it away from electromagnetic part
 - Fix ECM firmly
 - Additional relay to protect ECM, check relay firstly at once showing ECM issue.



19-06. Injector / Intake

Injector is a electromagnetic coil ass'y which receiving messages from ECM to turn "ON" or "OFF" on sphere vale to control injecting timing.

- Working
 - with multit-point injector
 - fuel pressure at 350 kPa constantly
 - temperature -30°C ~ 120°C
- Installation
 - to compose injector/holder/jointer
=> smell gasoline on the surface
=> slightly turn injector into jointer to correct position

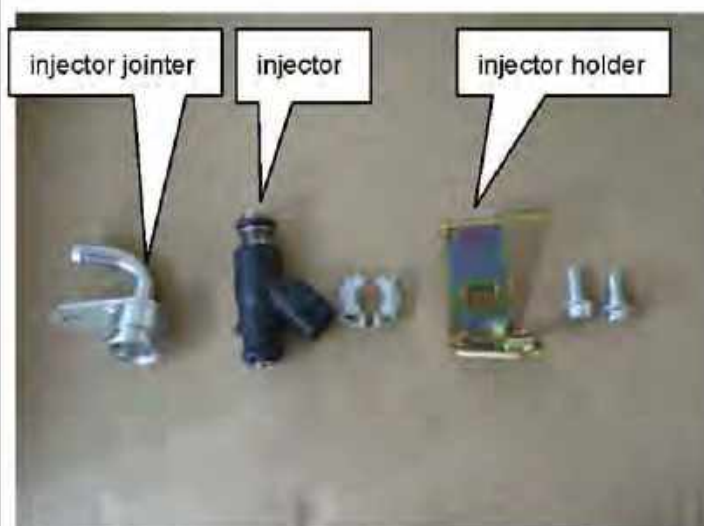

- => latch the circlip to the convex of injector
- => inley holder to injector correctly
- => fix screw to the injector



- Install injector comp. to engine
 - => hold injector comp. and fix bolt to the intake base
 - => check installation in vertical and without clearance with intake base
 - => connect the special coupler and ensure correctly installation
- Hold jointer and connect fuel hose firmly correctly.



● Removal

- disconnect the special coupler
- hold the injector holder to unscrew bolt
- slightly remove out the injector
- keep all in order and clean, if necessary, clean all by solvent



● Inspection

- clogged => clean by supersonic machine or add cleaning solvent
- leakage => replaced
- shortage checked by circuit tester => replaced

- ensure connection => less to plug in and out
- Intake manifold
Refer to 6-08

19-07. Throttle Body

Throttle body control the clean air into engine by valve. Air get into cylinder through intake and mix with fuel from injector. To control the air properly by sensors on it and ECM.

- Refer to 4-04 & 4-05
Suggest not to dismantle throttle body without professional trainings
- Inspection & cleaning
 - Prior to disassembly, mark the TPS original position with paint for accurate reinstallation
 - Make sure the valve open and close smoothly. If TPS adjustment is necessary, refer to 19-03.
 - Do not loosen the nut of idle screw, if adjustment is necessary, refer to 19-03.
 - Clean passageways with a spray-type cleaner and blow dry with compressed air. Do not use wire to clean passageways. If the components can't be cleaned it may be necessary to use a dip-type cleaning solution and allow them to soak. Follow the instructions carefully. Do not apply cleaning chemicals to the rubber and plastic materials.

Warnings:

- 1) Some cleaning chemicals, especially dip-type soaking solutions, are very corrosive



and must be handled carefully.

2) Normally, the removed O-ring must be replaced with a new one. Replaced the component if o-ring not provided as spare.

19-08. Fuel pump assembly / Fuel tank

The fuel in the fuel tank is pumped up by the fuel pump and pressurizes fuel flows into the injector installed in the intake manifold by fuel delivery pipe. Fuel pressure is regulated by VSR in the pump ass'y. As the fuel pressure applied to the fuel injector is always kept at absolute fuel pressured of 350 kPa, the fuel is injected in conic dispersion when the injector opens according to the injection signal from the ECM. ECM get message from CSS (crankshaft sensor) at once turning on main switch, it will not work when crankshaft doesn't work.

There is no fuel return hose.

Attention: Do not dismantle fuel pump without professional trainings. To keep a good condition for riding, a period replacing whole set fuel pump is necessary in every 3~ 4 years running.

- Refer to 4-06 & 4-08.
Suggest not to dismantle fuel pump ass'y without professional trainings.
- Working
 - constant fuel pressure at 350kPa
 - under fuel temperature 60°C
- Assembling / Installation
 - VSR assembling

1) smell gasoline on o-ring and white



edge

- 2) install VSR to pump bracket
- 3) cover the VSR fixing plate (cutting edge forward to inside)
- 4) fix the two screws by certain torque.

Fixing Torque: 1~1.5 kg/m

■ fuel filter / pump assembling

- 1) notice the flow direction

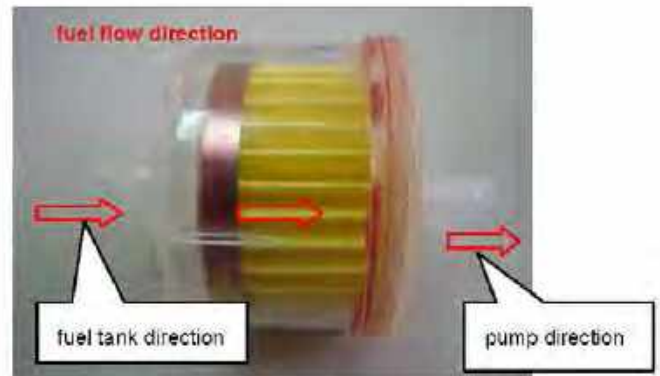

- 2) ensure two hoses installed with firmly clamps.

- 3) fuel pump fixed with a damper installing to bracket and connect to hose
- 4) Connect harness and ensure coupler firmly connection



- 5) fix the clamp for pump by screw

Fixing torque: 1~1.5 kg/m

=> the damper have to be matched to the plate

=>can not crash the pump



● Inspection and attentions:

- leakage checking
 - a) enough fuel in the fuel tank
 - b) switch on for 3 seconds and switch off for 15 seconds for 3~4 times

c) check the fuel pump assembly leakage

- Check fuel pressure
=> use gauge to check fuel pressure.
Connect to fuel delivery hose.

Fuel pressure: 350kPa

=> replace a new delivery hose

a) All components can't be touched each other.

b) Replace hose pipes at least in every 3 years running

=> crash/aged/uneven=> replaced

c) Always replace a new clamps

d) Do not pump the fuel pump without fuel

e) Do not pick up fuel pump by pulling harness

f) Ensure correct clamps, screws and hoses.

g) Do not exhaust fuel in the fuel tank

h) Do not torture filter element in fuel tank

i) Filter have to be checked in every 500~1000 km running.

Deteriorated/clogged=> replaced

Damaged => replaced

j) Fasten well on harness averting from sharp edge or steel parts

● Removal

- Release fuel from fuel pump
 - 1) shift the gear to be neutral
 - 2) disconnect wire harness from fuel pump
 - 3) start engine to run till stop running
 - 4) switch on/off for 3 seconds for 3 times



Attention:

Release all fuel before removal.

Work in well ventilated are.

Keep away from fire or spark.

19-09. Fuel delivery hose

Fuel delivery hose delivery the fuel from fuel tank to injector at absolute fuel pressure of 350kPa. It's with high destiny rubber and secured by firm clamps.

- Removing or reinstalling fuel delivery hose, always hold the opposite component (fuel pump ass'y or injector ass'y)
- Inspect fuel delivery hose within very 3 months or 700~1000 km.
- Replace fuel delivery hose within every 3 years.
- Any damage/leakage/aged/uneven => replace
- Replace new clamps in every removing

19-10. Oxygen sensor / exhaust pipe

O² sensor is a element with multilayer ceramic. Zirconia is the most one. O² sensor is equivalent to a kind of battery which differ to the oxygen ions on both + - (in/out) electrodes to identify the air/fuel ratio (A/F) and send message to ECM.

- Working
 - Ideal working temperature 650°C~800°C
 - Works 1000°C in long run will reduced the life time.
 - Avoid to hit by objects when riding



- Avert the frozen ice accumulated near sensor.
- Assemble
 - use wrench to fix it to exhaust-pipe
- Torque: 4~6 kg/m (40~60Nm)**

 - connect wire harness
=> avoid to torture the ex-harness
- Inspection
 - damage/removal/aged=> replaced
 - shortage => replaced
- Removal
 - Always remove exhaust-pipe unit with O² sensor when maintenance
 - Refrain to remove O² sensor itself, the unit coated with anti-sintering agent to decrease burnt. To coat anti-sintering agent before reinstalling back the unit, otherwise, replace a new one.
- Exhaust-pipe
Refer to 5-04



19-11. Ignition coil

Primary coil start to charge under ECM message and high voltage generated to spark plug ignite. ECM take control on ignition, pause and sparking.

- Installation
 - ground wire have to be connect to coil ass'y
 - a bolt to fix to frame
Torque: 1 kg/m (10 Nm)
 - Connect wire harness
 - Turn spark plug cap to spark plug
=> firmly into proper position



=> move forward and backward to check

● Inspection

No high voltage output

■ primary peak voltage checking

=> connect multi-circuit tester

- 1) Shift the gear to the neutral, turn the ignition switch "ON"
- 2) Press the starter button and allow the engine to crank for a few seconds, and then measure the ignition coil primary peak voltage.

**Ignition Coil primary peak voltage
80V or more**

=> replace it if not in the range

■ Ignition coil resistance checking

=> connect multi-circuit tester

=> measure ignition coil resistance in both the primary and secondary coils.

Ignition coil resistance:

Primary: $0.58 \pm 0.058 \Omega$

((+) terminal – (-)Ground)

Secondary: $7.1 \pm 0.71 k\Omega$

(spark plug cap – (-) terminal)

19-12. Engine temperature sensor /

Cylinder head

ETS sends message to EMS, EMS determine the engine working condition. In Delphi, it execute to sensor coolant and engine temperature and send two messages to ECM.

● Installation

- Use wrench to screw up to cylinder head

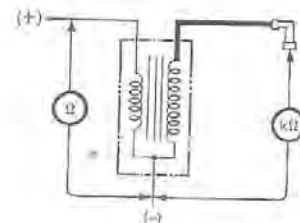
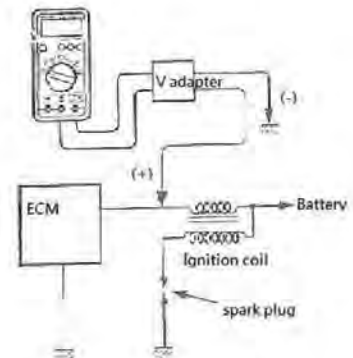

Torque: 1.5kg/m (15±2Nm)

- Connect coupler correctly and lightly (≤60N)
- Inspection
 - Shortage/damage=> replaced

19-13. Gear Position Switch

It need to send related messages (2*4/4*4/speed control...) to ECM. It's different from the one for carburetor.

- Identify the mark (MAX-001) on the unit.
- Shortage => replaced



19-14. Crank Position Sensor /

Generator assembly

- Refer to 9-04
- Install generator to right cover of crankcase and fix CPS by two bolts correctly
- Ensure CPS output voltage $\geq 3.0V@300rpm$
- Ensure correct clearance between CPS and flywheel at 1.1mm

CPS clearance : 1.1mm

- Flywheel fixing in a certain torque.

Torque: 12 kg/m (120Nm)

- Correctly connect coupler to harness



19-15. Relays control

For security for ECM/Fuel pump/Fan motor, SMC install three more relays to secure these three working systems.

●

Parts no.	Parts	Function	Coupler color
62550-SK2-00	relay	EFI system	black
62550-SK2-00	relay	Fuel pump	green
62550-SK2-00	relay	Fan motor	white

● Check Relay

First, check for insulation with the multi-circuit tester between terminals "A" & "B". Next, check for continuity between "A" and "B" with 12V voltage applied, positive (+) to terminal "C" and negative (-) to terminal "D". If continuity does not exist, replace relay with a new one.

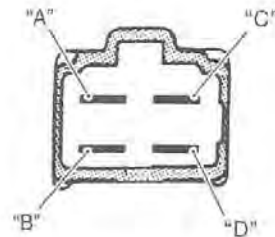

19-16. Speedometer

Most important difference in EFI speedometer is "check engine warning lamp". Refer to 19-03.

● "MAX-001" is specified for EFI.

● "check engine warning lamp"

● Refer to Instruction for speedometer.



19-16. Lean switch (tilt sensor)

- Refer to 19-03.
- Installation
 - install it on the flat level
 - fix it as direction \uparrow up to the bracket by two bolts

Fixing torque: 1.5~2.5Nm

- Inspection
 - check function
 - => start engine
 - => loosen a bolt
 - => tilt to more than 65° → engine stop
 Tilt angle: $65^\circ \pm 10^\circ$
 - measure output voltage by circuit-tester
 - => set main switch to "ON"
 - => tilt the sensor angle to 65°
 - => measure output voltage
 - do not touch the contact of switch

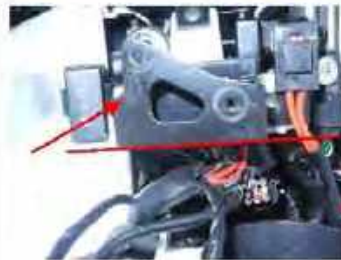

19-17. Fault code

Refer to 19-03.

- Fault code: P0107/P0108
- MAP Circuit Low Voltage or Open / MAP Circuit High Voltage

Note: Delphi combine MAP/MAT in one unit, normally means IAP and IAT sensors separately.

- clogged vacuum passage throttle body

and MAP

- Air being drawn from vacuum passage between throttle body and MAP
- MAP circuit open or shorted to the ground
- MAP sensor malfunction
- ECM malfunction
- Sensor voltage not within the range
 - $3.26V \leq \text{sensor voltage} \leq 6.6V$
 - =>sensor voltage is higher than specified value
 - sensor circuit is open or shorted to power sensors or ground circuit open
 - =>sensor voltage is lower than specified value
 - sensor is shorted to the ground or power sensors open

Note: Atmospheric pressure varies depending on weather conditions as well as altitude. Take into consideration when inspecting voltage.

● **Fault code: P0112/P0113**

→ **IAT Circuit Low Voltage / IAT Circuit High Voltage or Open**

- MAT sensor circuit open or short
- MAT sensor malfunction
- ECM malfunction
- sensor voltage not within the range
 - $3.26V \leq \text{sensor voltage} \leq 6.6V$
 - =>sensor voltage is higher than specified value
 - sensor circuit is open or ground circuit open
 - =>sensor voltage is lower than specified value
 - sensor is shorted to the ground

● **Fault code: P0117/P0118**

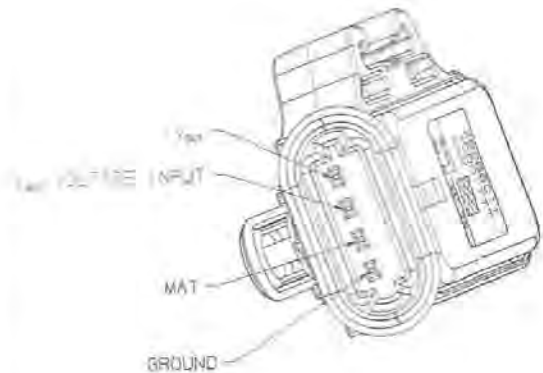

→ Coolant/Oil Temperature Sensor Circuit
Low Voltage / Coolant/Oil Temperature Sensor
Circuit High Voltage or Open

- Installation condition checking => loosen or pinching
- Connections checking
=> check the coupler of any pins that may pulled out.
=> check the locking condition of the coupler
- Open or short circuit in wire harness
=> repair or replace if there is an open or short circuit between CTS and ECM.
- Defective CTS => Use circuit tester check the followings Ω
Defective => replaced

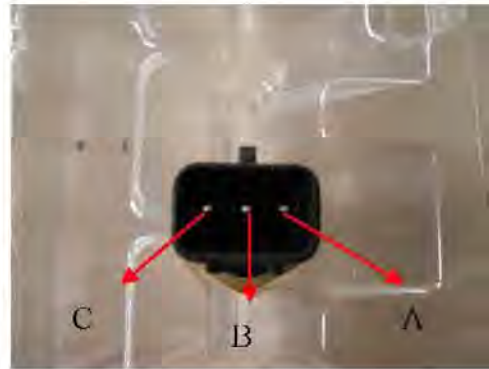

$^{\circ}\text{C}$	Ω
60	164.5 ± 16
80	82.6 ± 8
100	44.6 ± 4
115	28.7 ± 3
125	22.5 ± 2

● **Fault code: P0122/P0123**

→ TPS Circuit Low Voltage or Open / TPS
Circuit High Voltage

- TPS maladjusted => refer to 19-03
- TPS circuit open or short
=> check for looseness or pinching
=> check the coupler for any pins that may have pulled out.
=> check the locking condition of the coupler.
=> any open or short circuit between TPS and ECU harness coupler
=> Defective TPS
1) use circuit tester to check Ω
=> $3\Omega \leq A \text{ \& \ } B \text{ ends} \leq 12\Omega$

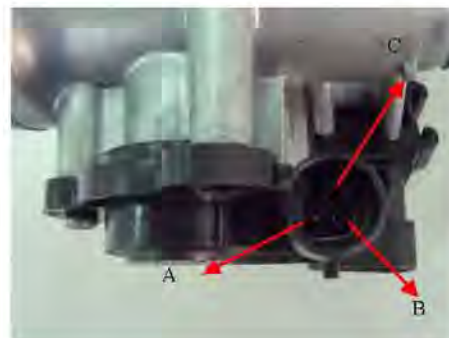

- 2) measure " C & A" and "C & B" Ω
- => the value are smooth (not floating)
- not as 1) & 2) => replaced TPS

● **Fault code: P0131/P0132**

Fault code: P0031/P0032

Fault code: P0137/P0138

Fault code: P0037/P0038

→ O²S 1 Circuit Low Voltage/ O²S 1 Circuit High Voltage

→ O²S Heater Circuit High Voltage/ O²S Heater Circuit

Low Voltage

- Installation checking
 - => check for looseness or pinching
 - => check the coupler for any pins that may have pulled out
 - => fixing torque too much
 - => malfunction on ECM
 - => engine overheating
 - => defective sensor
- 1) use circuit tester to check heater end Ω
 $8\Omega \leq \text{heater end} \leq 11.2\Omega$
- 2) out of specification => replaced

● **Fault code: P0201/P0202**

→ **Injector 1 Circuit Malfunction/ Injector 2**

Circuit Malfunction

- Connection checking
 - =>check the couplers for any pins pulled out.
 - => installed in vertical
 - => fuel system pressure at 350kpa
 - => any open or short circuit between fuel injector coupler and ECU coupler
 - => defective injector
- 1) clogged => clean
- 2) use circuit tester check the Ω
Specific $\Omega = 12 \pm 0.6\Omega$
- 3) out of specification=> replaced

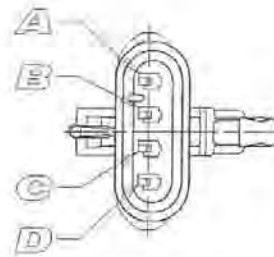

- A: gray= sensor (ground)
- B: black= sensor (output)
- C: white= heater (-)
- D: purple= heater (+)



● **Fault code: P0230/P0232**

→ **FPR Coil Circuit Low Voltage or Open / FPR Coil Circuit High Voltage**

- Fuel pump relay circuit open or short
- Fuel pump relay malfunction
- ECM malfunction
- Fuel pump relay switch circuit shorted to power source.
- Faulty fuel pump relay
- Fuel pump relay coil circuit open or short
- refer to 19-15

● **Fault code: P0336/P0337**

→ **CKP (crankshaft position)Sensor Noisy Signal / CKP Sensor No Signal**

=>The signal doesn't reach ECM for 3 sec. or more after receiving the starter signal.

- Connection checking: wire and couplers
- Metal particles or foreign material being stuck on the CKP sensor and rotor tip.
- CKP sensor circuit open or short
=> connect circuit tester (+) B (-) G
=> $400\Omega \leq \text{CKP} \leq 590\Omega$
=> out of specification → replaced CKP / stator
- CKP sensor malfunction
- ECM malfunction

● **Fault code: P0351/P0352**

→ **Cylinder Ignition Coil Malfunction**

- Connection checking: wire/couplers/locking
- Open or short circuit
- Test the primary and secondary coil by circuit tester => refer to 19-11



● **Fault code: P0505**

→ **Idle Speed Control Error**

- TPS loosen => fix => refer to 19-03
- TPS not in the range => adjust => refer to 19-03
- Engine speed is high when idling
 - => open circuit in harness
 - => malfunction in the throttle body
 - => malfunction in throttle cables
 - => malfunction in ECM
 - => relay defective
 - => fuse blown
- refer to 19-03

● **Fault code: P0562/P0563**

→ **System Voltage Low/High**

- Battery output volt
 $10V \leq \text{battery output} \leq 16V$
- Connection checking
- Malfunction in charging system => refer to Chapter 21.
- Open or short circuit in harness
- Malfunction in ECM.

● **Fault code: P0650**

→ **MIL (malfunction indicator lamp) Circuit Malfunction**

- Connection checking: coupler, terminals, harness
- Relay and fuse checking
- Malfunction in ECM
- Malfunction in speedometer
- ECM self-diagnostic function checking and memory function checking
- refer to 19-03

● **Fault code: P1693/P1694**

→ **Tachometer Circuit Low Voltage/
Tachometer Circuit High Voltage**

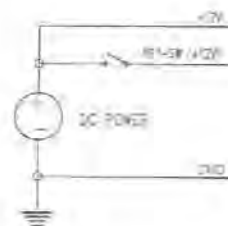

- Connection checking: coupler, terminals, harness
- open or short in harness
- relay and fuse checking
- ECM malfunction
- Speedometer defected
 - => check the circuit
 - => LED indicator function checking

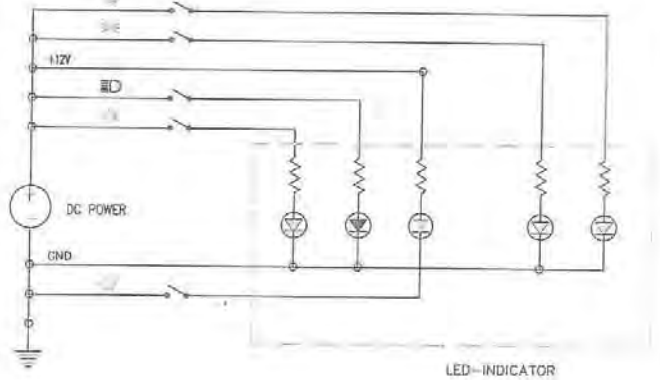

● **Fault code: P0500**

→ **VSS No Signal**

Vehicle Speed Sensor located to the right side of engine. Sensor message send to speedometer generating speed signal to ECM.

- Connection checking for coupler, terminals and harness.
- Open or short in harness
- Malfunction on ECM / speedometer
- Working temperature
 - 20°C~150°C
- Defective VSS → replaced
 - => deteriorated
 - => overheated lubricant
 - => damaged
 - => degaussed



● **Fault code: P0850**

→ **Park Neutral Switch Error**

- Connection checking for coupler, terminals and harness.
- Open or short in harness
- Malfunction on ECM / speedometer
- Defective gear selector switch=> replaced
 - => deteriorated
 - => shortage
 - => clogged
 - => worn



- **Fault code: P0445/P0444**

- **CCP short to high/ CCP short to low/open**

A canister solenoid valve to be used in vehicle.

- Check the connection
- Open or short in wire harness
- Malfunction on ECM

- **Fault code: P0171/P0172/P0174**

- **BLM Max Adapt/ BLM Min Adapt/ PE system Lean**

- refer to 19-03

NOTE:

20-01. Mechanism Diagram.....
 20-02. Maintenance Data.....
 20-03. Technical Specification.....
 20-04. Trouble Diagnosis.....
 20-05. Battery.....
 20-06. Charging System.....
 20-07. Ignition System.....
 20-08. Starting System.....
 20-09. Meters.....
 20-10. Light / Bulb.....
 20-11. Switch / Horn.....
 20-12. Sender Unit.....
 20-13. Cooling Fan Thermo Switch.....
 20-14. Thermo Unit.....

20-01. Mechanism Diagram

Carburetor

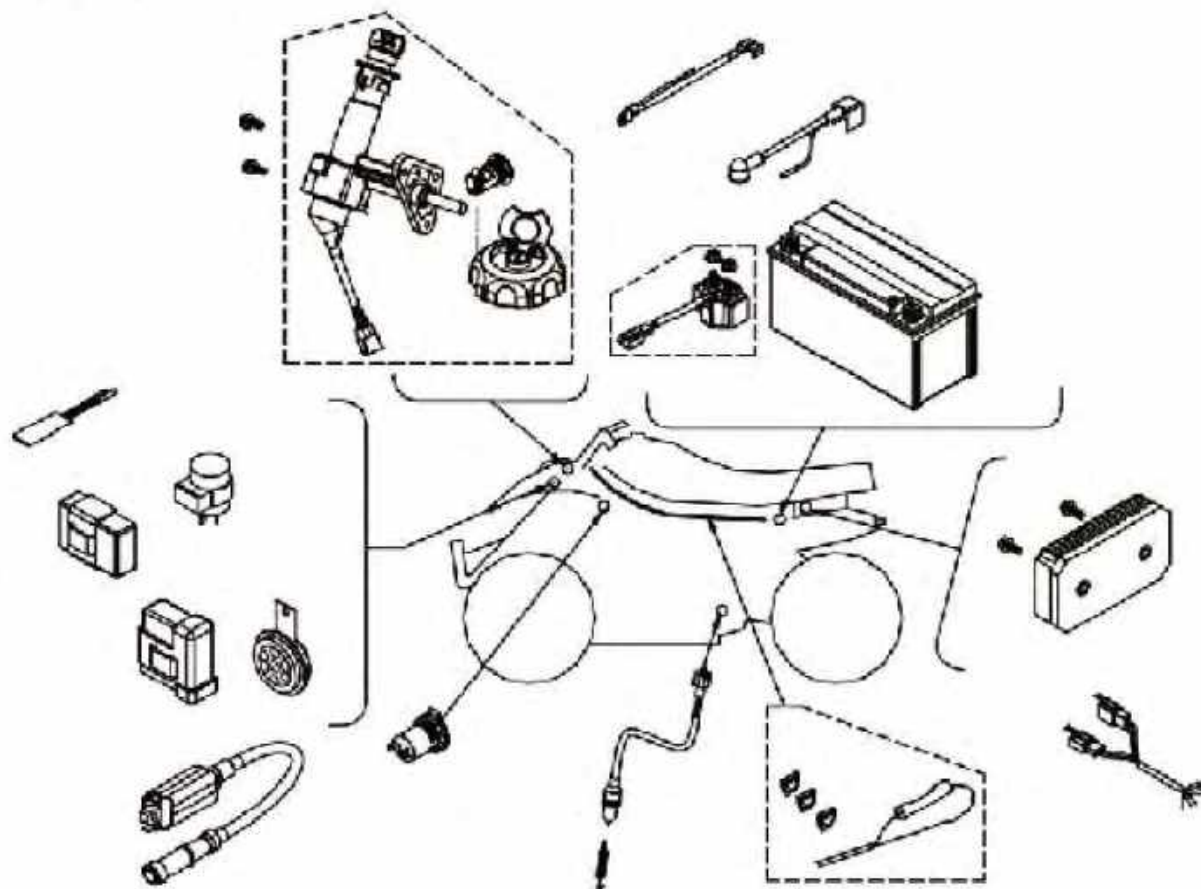

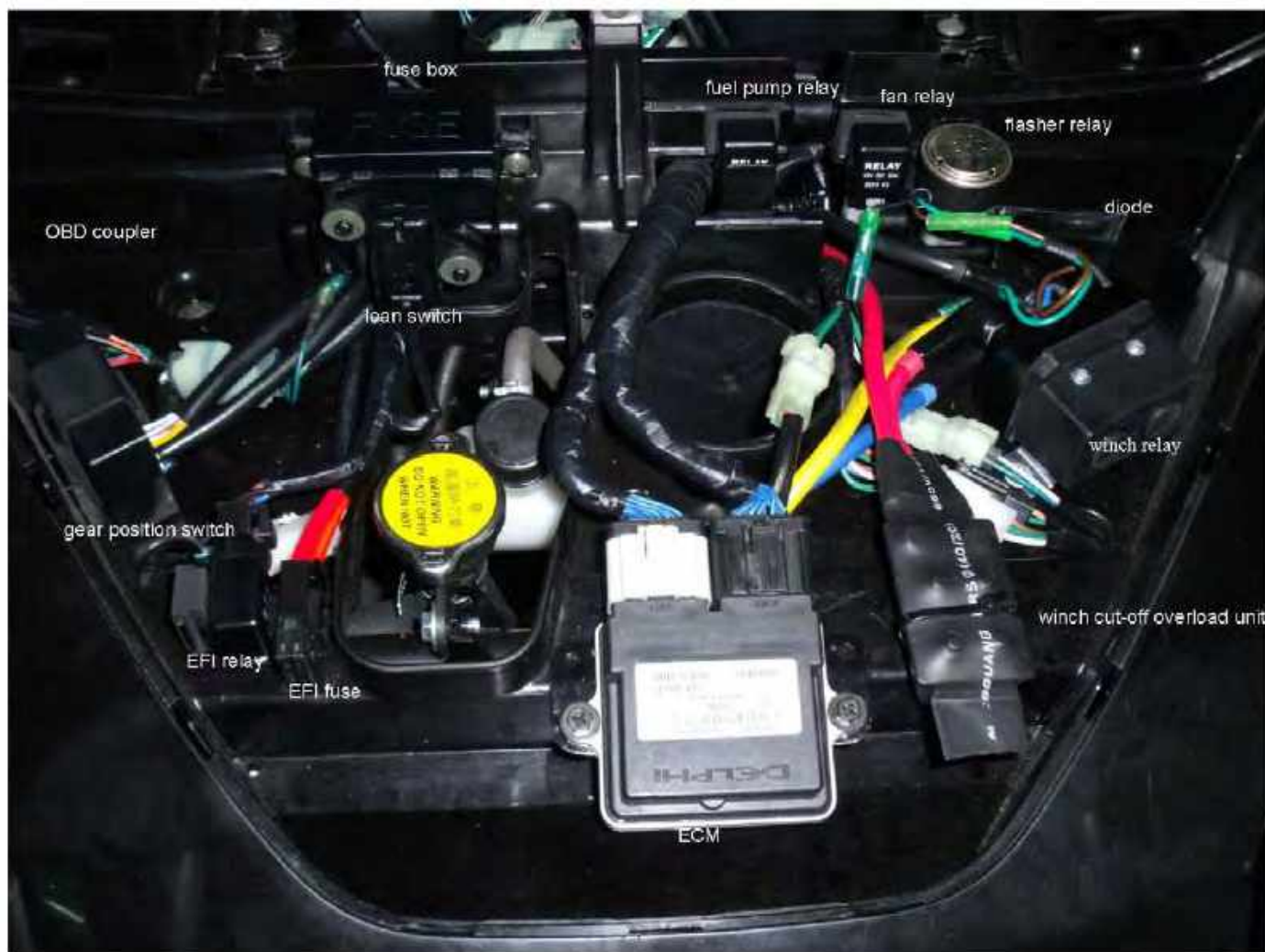

20-02. Maintenance Data

Operational precaution

- When remove the battery, the disconnection sequence of cable terminals shall be strictly observed. (First disconnect the negative cable terminal, next, the positive cable terminal.)
- The model of the spark plug and the tightening torque.
- The ignition timing.
- Adjustment of headlight.
- Removal and installation of AC generator.
- The maintenance free battery requires no inspection of electrolyte level and refilling of distilled water.
- To recharge the battery, remove the battery from rack without removing ventilation caps.
- Unless in emergency, never rapid charge the battery.
- The voltage must be checked with the voltmeter while charging the battery.
- As C.D.I assembly does not require an ignition timing check. In case ignition timing is incorrect, check C.D.I and AC generator. Verify with an ignition timing light after replacement if necessary.
- The ECM is equipped with a self-diagnostic function in order to ensure that the fuel system is operating normally. Once a malfunction has been detected, a fault code is stored in the memory of ECM.
- Fault code can be read by OBD.
- Do not disconnect coupler from ECM, the battery cable from the battery, ECM ground wire harness from engine or main fuse before confirming OBD stored in memory.
- Stop and check when "Check engine warning lamp" turning on.

20-03. Technical Specification

a. Charging system

Description		Specification
Battery	Type	MF type, factory default: GS or YUASA Brand
	Capacity	12V18Ah (GTX20L-BS or YTX20L-BS)
	Charging rate	1.4A / 5 ~ 10 hours (standard) hour 9A / 0.5(fast charging)
Leak current		< 1mA
Charging current		1.2 A / 1500rpm
Control voltage in charging		14.5 + 0.5 V / 1500rpm

b. Ignition system

Description		Specification
Spark plug	Model	NGK CR7E(Recommended)
	Gap	0.7~0.8mm
Ignition coil and resistance	Primary winding	2.9 ±10%Ω / 0.58±10%Ω(EFI)
	Secondary winding	Without cap: 2.9 ±10%Ω / 7.1±10%Ω(EFI)
		With cap: 15 ±10%KΩ
Ignition timing "F" mark		15°TDC/1700rpm
		46°TDC/4200rpm

20-04. Trouble Diagnosis**a. No voltage**

- Battery discharged
- The cable disconnected
- The fuse is blown / incorrect fuse
- Improper operation of the main switch
- Malfunction on ECM

b. Low voltage

- The battery is not fully charged
- Poor contact
- Poor charging system
- Poor voltage regulator
- Malfunction on ECM

c. No spark produced by spark plug

- The spark plug is out of work
- Broken or shorted ignition coil
- The cable is poorly connected, open or short-circuited between A.C.G. and C.D.I.
 - Poor connection between C.D.I. and ignition coil
 - Poor connection between C.D.I. and the main switch
- Poor main switch
- Relay shorted
- Poor C.D.I.
- Incorrect spark plug gap / heat range
- Fouled spark plug
- Faulty spark plug cap
- A.C.G. is out of work
- Poor grounded
- Malfunction on ECM

f. Charging system does not operate properly

- Burnt fuse/incorrect fuse
- Poor contact, open or short circuit
- Poor regulator
- Poor A.C.G.
- Poor grounded
- Relays shorted

g. Engine does not crank smoothly

1. Primary winding circuit
 - Poor ignition coil
 - Poor connection of cable and connectors
 - Poor main switch
2. Secondary winding circuit
 - Poor ignition coil
 - Poor spark plug
 - Poor ignition coil cable
 - Current leakage in the spark plug
3. Incorrect ignition timing
 - Poor A.C.G.
 - Improper installation of the pulse sensor
 - Poor C.D.I.
4. Broken A.C.G. rotor woodruff key
5. Faulty crankshaft position sensor
6. Malfunction on ECM

h. Weak starter motor

- Poor charging system
- The battery is not fully charged
- Poor connection in the windings
- The motor gear is jammed by foreign material
- Worn or damaged starting clutch
- Poor grounded

d. Starter motor does not work

- The fuse is blown/ incorrect fuse
- The battery is not fully charge
- Poor main switch
- Poor starter switch
- The front and rear brake switches do not operate correctly
- Loose connections/ shorted wire
- Faulty starting clutch
- Faulty crankshaft position sensor
- Starter relay is out of work
- The ignition coil is poorly connected, open or short-circuited
- Poor grounded
- The starter motor is out of work
- Malfunction of ECM

e. Intermittent power supply

- The connector of the charging system becomes loose
- Defect regulator
- Poor connection of the battery cable
- Poor connection or short-circuit of the discharging system
- Poor connection or short-circuit of the power generation system
- Incorrect ignition timing
- Incorrect valve clearance
- Humility wire connections
- Clogged air filter
- Poor fuel pump function
- Malfunction of ECM

i. Starter motor is working, but engine does not crank

- Poor starter motor pinion
- The starter motor run in reverse direction
- Faulty crankshaft position sensor
- Broken ACG rotor woodruff key
- Clogged air filter
- Incorrect valve clearance
- Malfunction on ECM

20-05. Battery

a. Removal

- Remove the seat, and then you can see the battery.
- Disconnect the negative cable terminal (green) first, then the positive cable terminal (red).
- Remove the battery.

b. Voltage Check

Use the digital voltmeter to check the voltage of the battery.

Voltage:

Fully charged: 13.0~13.2 V at 20°C

Undercharged: Below 12.3 V at 20°C

c. Charging

- Connect the positive terminal (+) of the charger to the battery positive terminal (+).
- Connect the negative terminal (-) of the charger to the battery negative terminal (-).

	Standard	
Maximum		
Charging current	1.4A	9.0A
Charging time	5~10H	1H

Warning

1. Keep flames away while recharging.
2. Charging is completely controlled by the ON/OFF switch on the charger, not by battery cables.

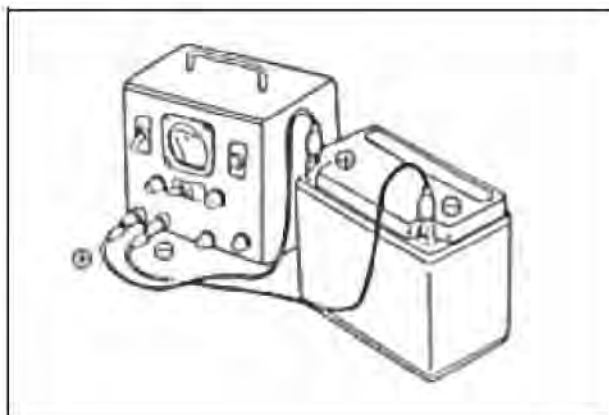
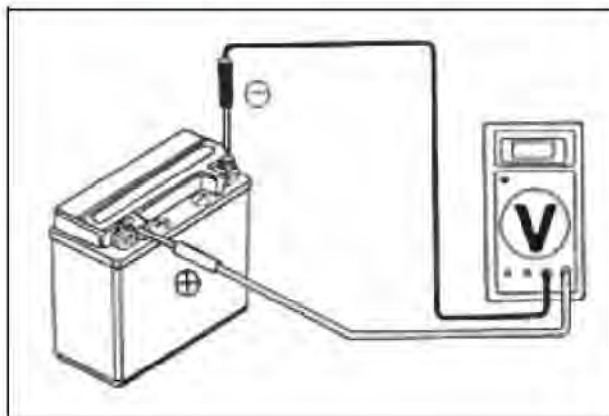

Caution

1. Never rapid charge the battery unless in emergency.
2. Verify the battery is recharged with current and duration prescribed above.
3. Large current and fast time charging could cause damage to the battery.
4. When installing the battery, coat the cable terminal with grease

20-06. Charging System

a. Charging circuit (Carburetor)

Charging circuit

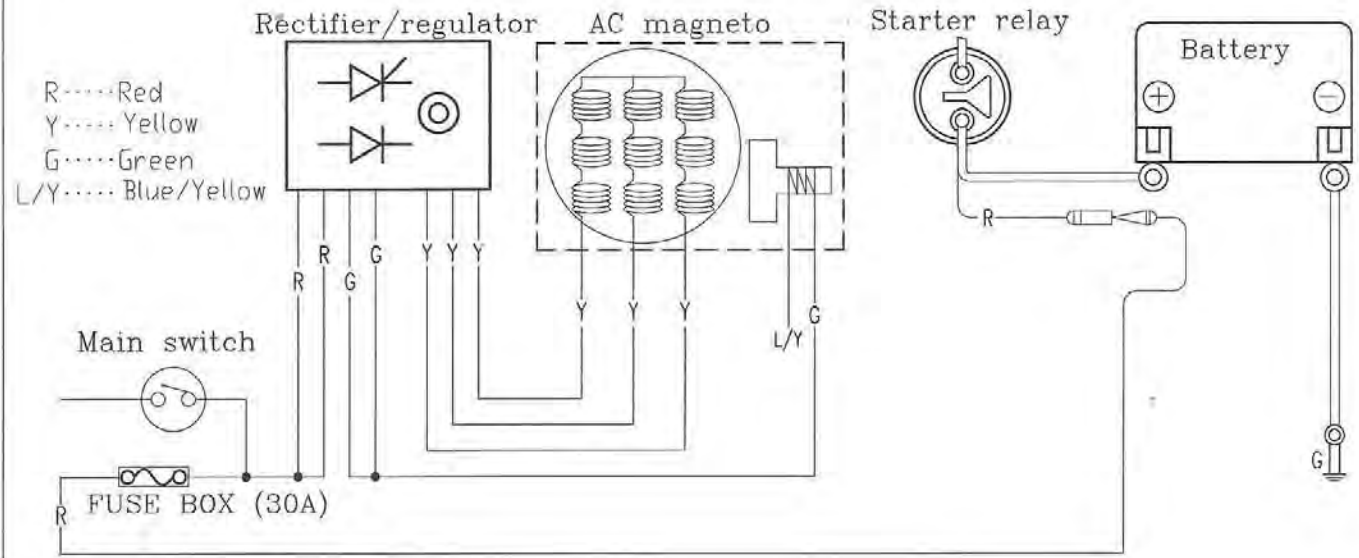

EFI

Charging circuit

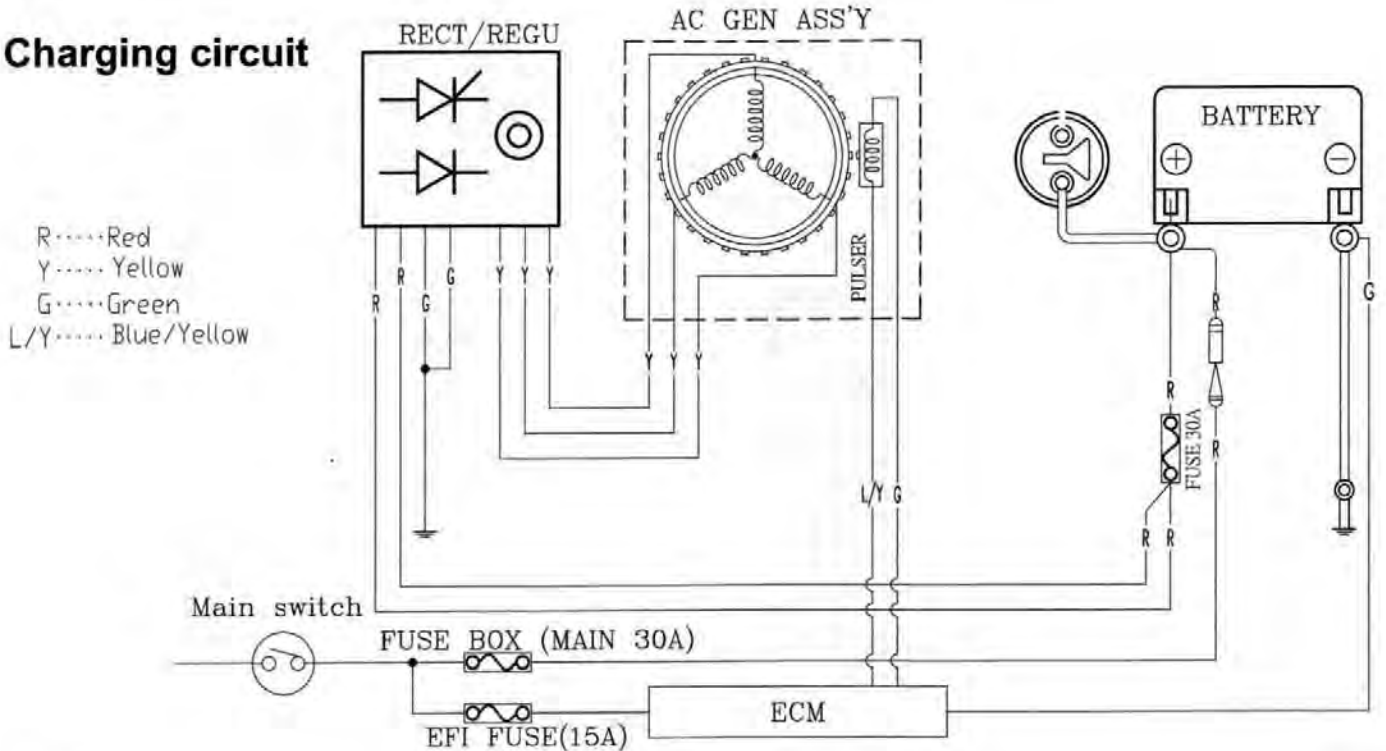

b. Current Leakage Inspection

- Turn the main switch to OFF position, and remove the negative cable terminal (-) from the battery.
- Connect an ammeter between the negative cable terminal and the battery negative terminal.

Caution

1. In the current leakage test, set the current range at the largest scale, then gradually decrease to the lower scale as the test process goes to avoid possible damage to the ammeter and the fuse.
 2. Do not turn the main switch to ON position during test.
- If the leaked current exceeds the specified value, it may indicate a short circuit.

Allowable current leakage: Less than 1mA

- Disconnect each cable one by one and take measurement of the current of each cable to locate the short circuit.

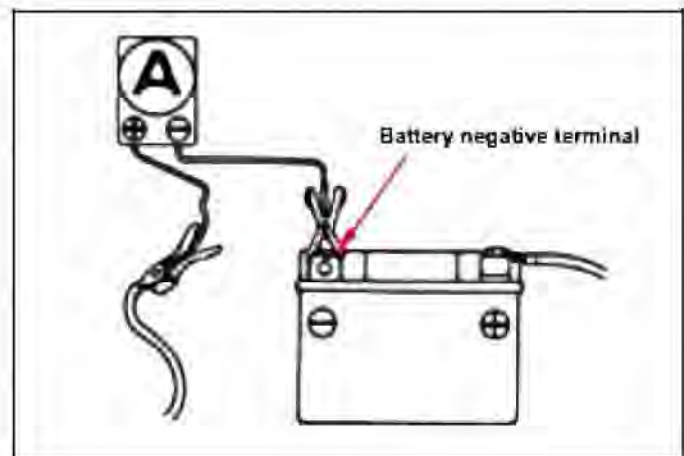

however, while the starter motor is activated, the surge current the motor draws from the battery may damage the ammeter.

- Use the kick starter to start the engine.
- The main switch shall be turned to OFF position during the process of inspection.
- Never tamper with the ammeter and the cable while there is current flowing through. It may damage the ammeter.

current is not.

- The replacement battery is aged and does not have enough capacity.
 - Battery used does not have enough electricity or is over charged.
 - The fuse of the ammeter is blown.
 - The ammeter is improperly connected.
- (3) The charging current is normal, but the voltage is not.
- The fuse of the voltmeter is blown.

Inspection on regulator rectifier

- Remove the seat, RH side cover
- Disconnect two couplers of the regulator

Rectifier.

Inspection the rectifier coupler to the wire harness passes the condition.

Item	Check Points	Standard Value
Main switch		
Connection	R – B	Battery voltage (ON)
Battery connection	R---G	Battery voltage
Charging coil	Y---Y	$0.235 \pm 20\% \Omega$

If the readings measured are not normal, check parts in the circuit.

If the parts are normal, then trouble is in the wiring.

If there is nothing wrong with parts and wiring, replace the regulator rectifier.

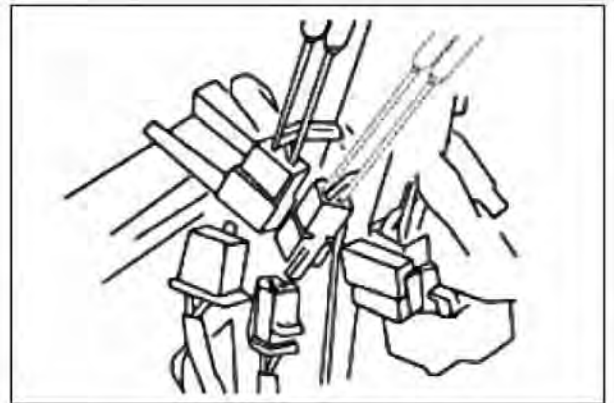

20-07. Ignition System

Ignition circuit diagram (Carburetor)

Ignition circuit diagram

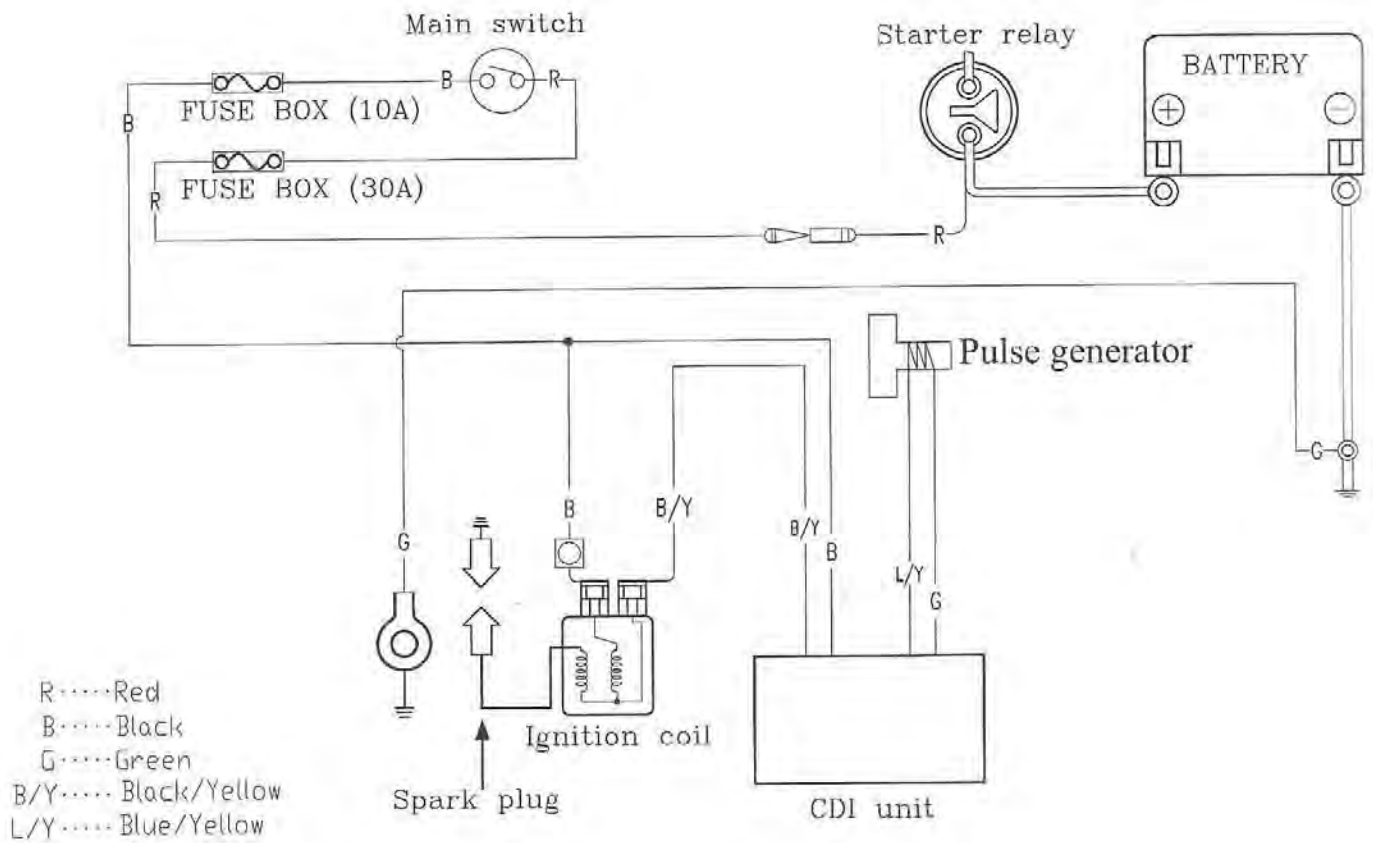

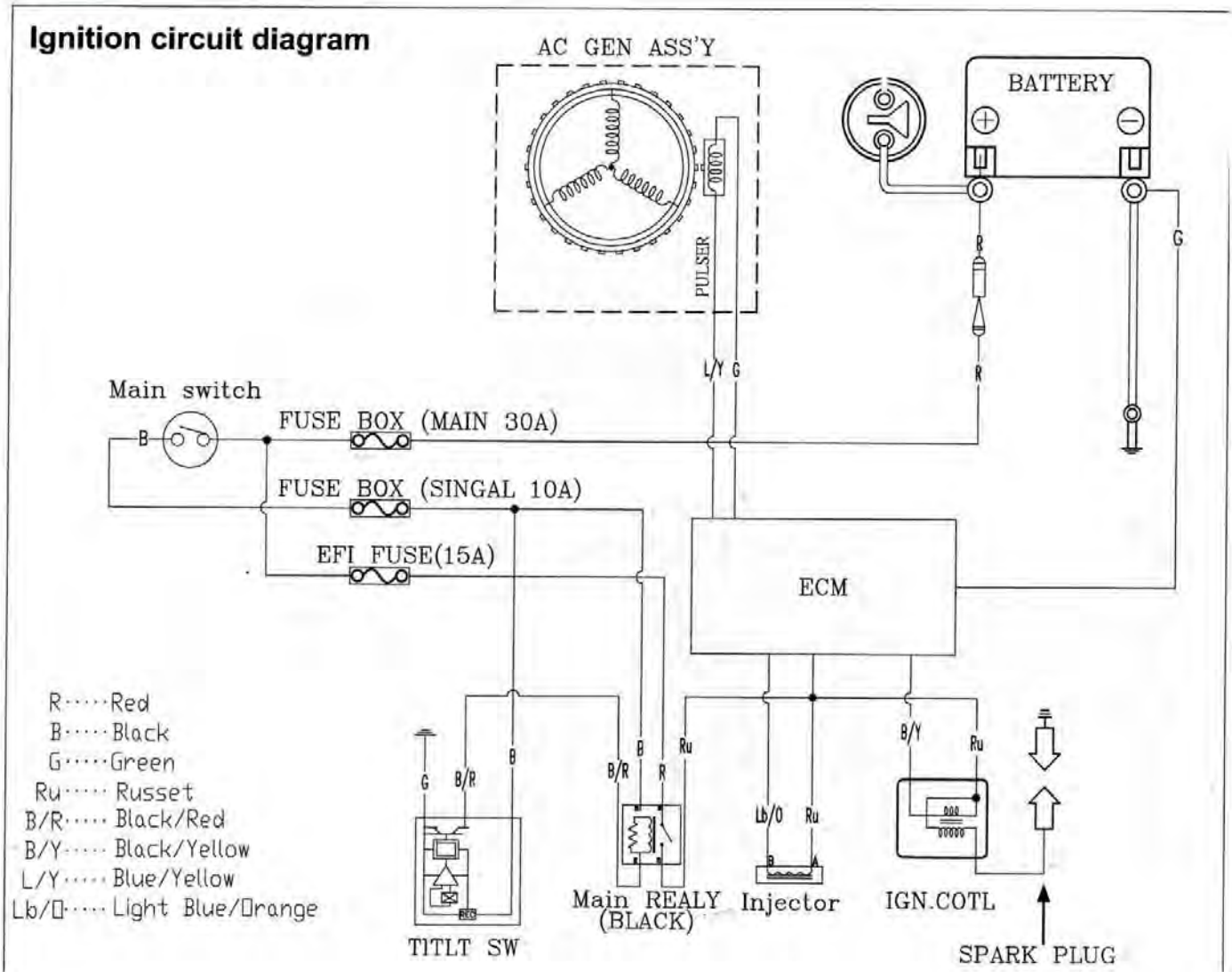
EFI

C.D.I unit (only carburetor)

Disconnect connectors of the C.D.I unit.

Check the following connectors as indicated in the table at the harness side.

Item	Points to check	Result
Main switch turn to "ON" position	B ~ W/B	Battery voltage
Pulse generator	B ~ G	495±20%Ω
Ignition coil	Primary circuit	B/Y ~ GND
	Secondary circuit	B/Y ~ with no cap
		B/Y ~ with cap
		2.9±10%Ω
		15.0±10%KΩ

Inspection on Ignition Coil

- Disengage the connector of the ignition coil and the spark plug cap.
- Measure the resistance between the terminals of the primary winding.
- Standard resistance: $2.9\Omega \pm 10\%$
- Remove the cap from the spark plug and measure the resistance between the spark plug and the primary winding.

Standard resistance:

With no cap: $2.9 \pm 10\% \Omega$

With cap: $15.0 \pm 10\% K\Omega$

Ignition Coil Replacement

Loosen the lock bolt and replace the ignition coil if necessary.

Connect wire harness in a right colors, ensure to earth green one.

Inspection of Pulse Generator

Disconnect the coupler of the pulse generator and measure the resistance between the terminals of blue and green.

Standard resistance: $495\Omega \pm 20\%$

- EFI refer to 19-11/19-12



20-08. Starting System

Starting circuit diagram

Starting circuit diagram

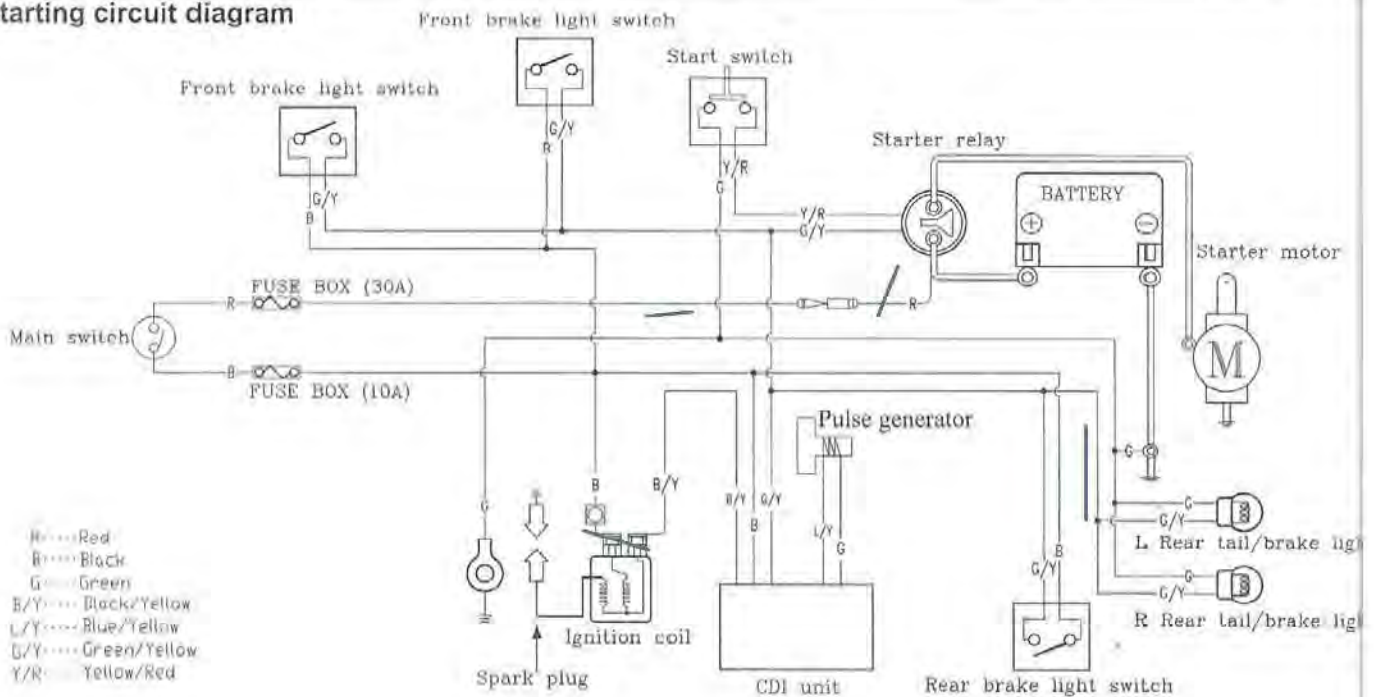

EFI

Starting circuit diagram

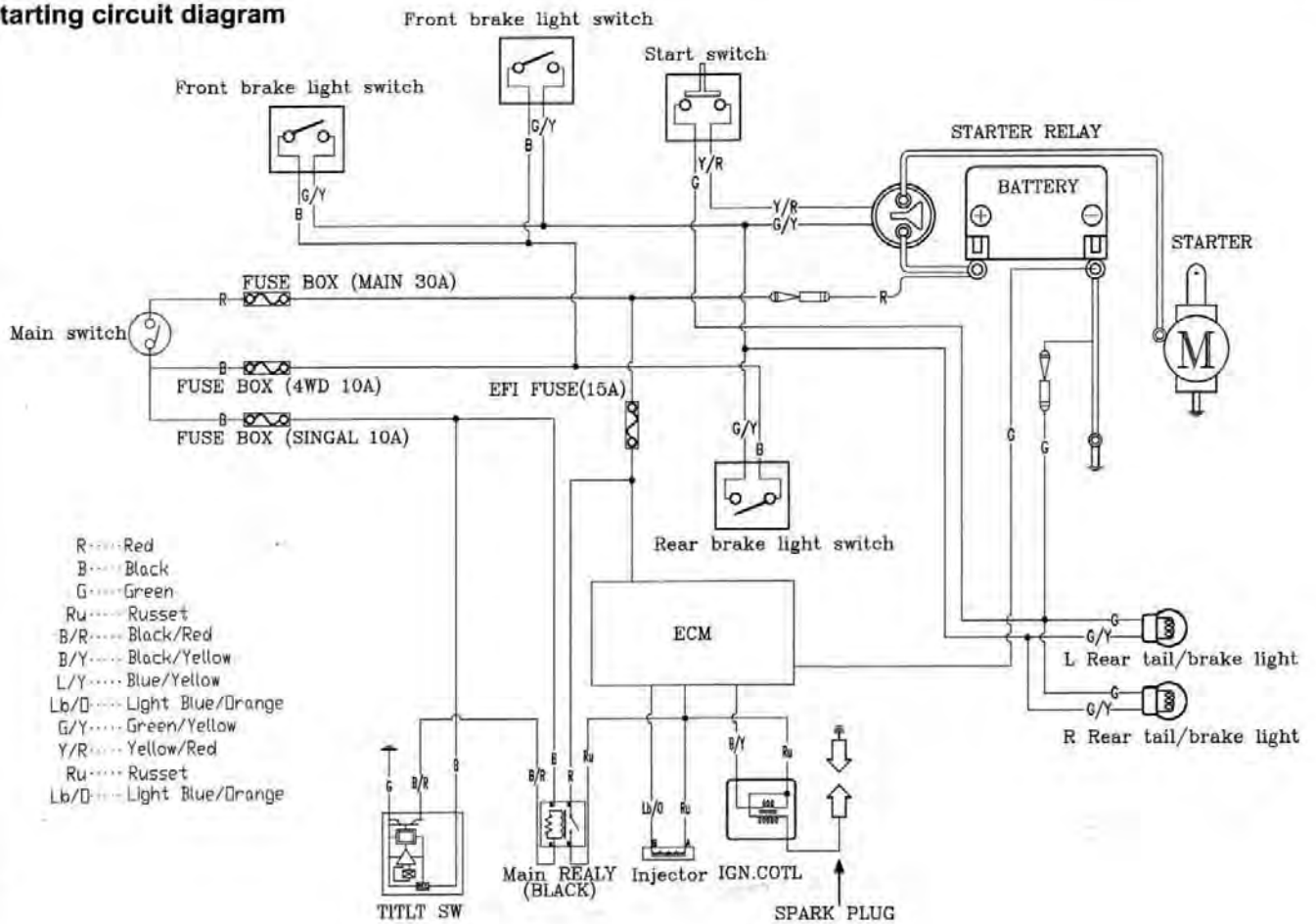

Inspection on starter relay

Open the main switch.

Press the brake.

Push down the starter switch.

If a sound of ."Looh Looh". is heard, it indicates the relay function normally.

Remove the seat.

Disconnect the negative cable terminal of the battery.

Disconnect the cable positive terminal from the relay.

Disconnect the positive cable of the starter motor.

Disconnect the coupler of the relay.

Connect an ohmmeter to the large terminal end.

Connect the yellow/red cable to the battery positive terminal and the yellow/black cable to the battery negative terminal.

Check the continuity of the large terminal end.
If there is no continuity, replace the relay.

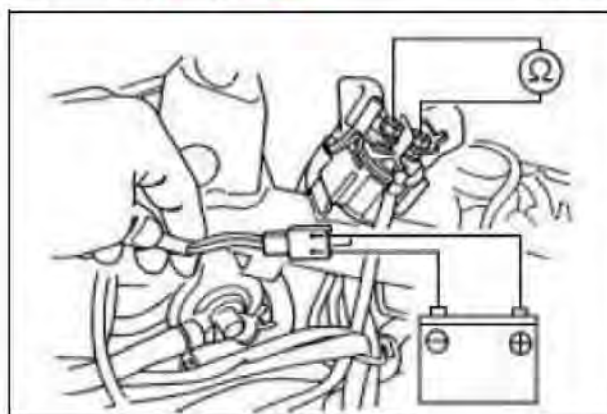

Removal of Starter motor

Remove the seat.

Disconnect the cable negative terminal (-), then the cable positive terminal (+).



Remove starter motor cable.

Loosen the lock bolts and remove the starter motor.



Installation of Starter motor

Install in reverse order of removal procedures.

20-09.Meters

- Refer to Instruction of Speedometer.
- EFI refer to 19-16



20-10. Light / Bulb

Replacing Bulb for Headlight

Remove waterproof cover for the headlight.

Remove bulb setting hook.

Take out the bulb connector and the bulb.
Replace with new bulb if necessary.

(High light H1 12V 35W)

(Low light H7 12V 35W)

Caution

Never touch the bulb with finger, which will create a heat point.

Clean the fingerprint left on the bulb with alcohol.

Install the bulb of the headlight in reverse order of removal.

Upon completion of replacement, turn on the main switch to ensure the headlight works well.

Adjust the beam and distance of the headlight if necessary.



Replacing the Front winker light Bulb

Pull out the front winker light bulb seat.



Replace with new front winker light bulb.
(12V 10W)



Replacing Bulb of Position Light

Pull out the position light bulb seat.



Replace with new position light bulb.
(12V 5W)

Replacing Bulb of Taillight and Rear Winker Light

Take out the rubber caps.

Turn the taillight and rear winker light bulb connectors by CCW.



Replace with new rear winker light bulb.
(12V 10W)



Replace with new taillight bulb.
(12V 21/5W)



Be sure to cover back the rubber caps.

Replacing Bulb of License Light

Pull the license light bulb connector out.
Replace with new license light bulb.



Replace with new license light bulb.
(12V 5W/)



20-11. Switch / Horn

Main Switch

Inspection

Remove the front center cover.

Disconnect the main switch coupler.

Check the continuity between three points as indicated below:

MAIN SWITCH			
	B	R	Br
OFF			
1	○	○	
2	○	○	○

Replacement of main switch

Disconnect the coupler of the main switch.

Push out the main switch.

Align the main switch stopper with the meter cover groove, and install main switch.

Install the main switch coupler.

Handle switches

Disconnect the coupler of handle from front fender left side.

Check the continuity between two points as indicated in the table below.

Start Switch

START	
	G Y/R
FREE	
PUSH	○ — ○

2WD/4WD/Diff Lock switch



LOCK SWITCH				
	G	W/L	Y/B	L/B
2WD	○	○		
4WD	○	○	○	
LOCK	○	○	○	○

Headlight Switch

LIGHT SWITCH			
	L	Br	W
	○	○	
		○	○

Winker switch

DIRECTION LIGHT			
	Lb	Gr	O
	○	○	
		○	○

Horn switch

HORN		
	G	Lg
FREE		
PUSH	○	○

Warning Light (Hazard)

WARNING LIGHT			
	Lb	Gr	O
	○	○	○
○			



Front Brake Switch

While grasp the brake lever firmly, the terminals of brown/blue and green/yellow of the brake should have continuity. Replace the switch if damaged.



Rear Brake Switch

While grasp the brake lever firmly, the terminals of white/black and green/yellow of the brake should have continuity. Replace the switch if damaged.

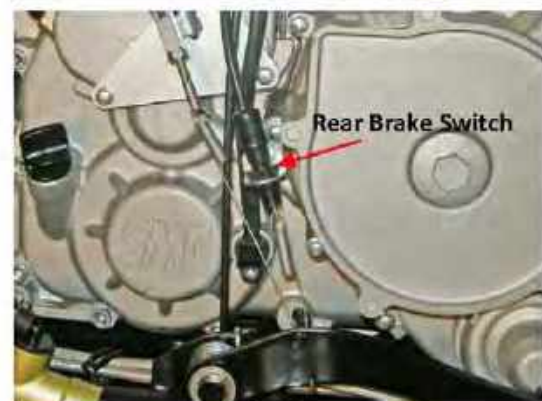

Horn

Remove the horn under front fender.

Apply **12 V** power source to two terminals of the horn, the horn should sound. Replace the horn if necessary.



20-12. Sender Unit

Remove the seat.

Remove the fuel tank cap.

Remove the upper center cover and front fender (refer chapter 13).

Disconnect the coupler of the fuel unit.

Remove the fuel unit (4 bolts).

Caution

Great care shall be taken not to damage or bend the float arm of the gauge.

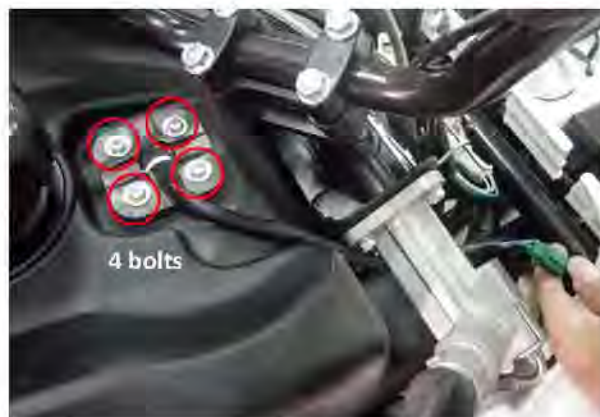

When the float arm shifts to the F position or the E position, the resistance measured shall be as follows:

Position	Resistance
E (Empty)	90~100 Ω
F (Full)	4-10 Ω

Connect the wiring to the fuel unit and the ohmmeter as shown.

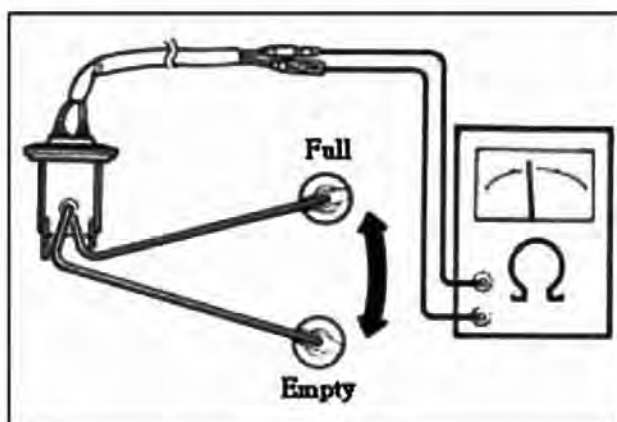

Connect the fuel unit coupler to the wire harness.

Turn on the main switch.

Move the float arm to verify the proper position the fuel gauge needle indicates.

Arm Position	Needle Position
Up (Full)	F (Full)
Down (Empty)	E (Empty)

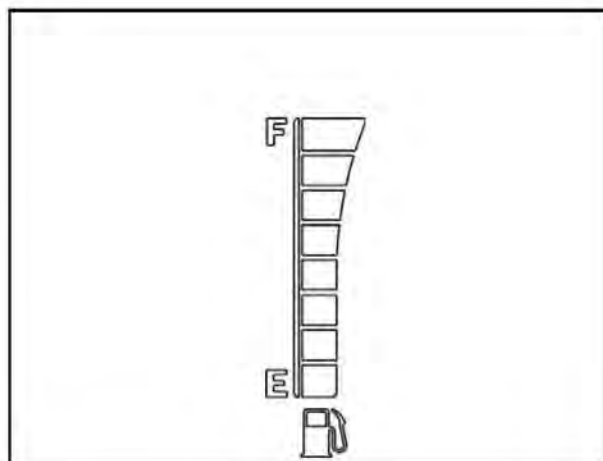

Caution

While conducting the test, turn on the direction indication lamp to make sure that the battery is in serviceable condition.

20-13. Cooling Fan Thermo

Switch

The thermo switch mounted on the radiator controls the operation of the cooling fan motor. In case that the fan motor fails to work, disconnect the green and black/blue leads and connect jump wires to the terminals, then, turn on the main switch, the fan motor should operate.

If the fan motor still fails to run, measure battery voltage between the green and black/blue leads.

If there is no voltage, check for blown fuse, loose connection or short-circuit.

If the fan motor runs, check the thermo switch in the manner as described below:

Hang the thermo switch on the bowl filled with coolant to check the switch's opening and closing temperatures, confirm the switch is open circuited at room temperature, and increase the coolant temperature gradually. The switch should have continuity at **85±3°C**.

Caution

Keep the coolant at a constant temperature at least for three minutes. Sudden increase the coolant temperature will cause the thermometer and the tester to indicate wrong readings.

Never let the thermometer and the thermo switch contact the wall of the bowl, which may result in wrong readings.

The thermo switch shall be placed in the coolant until the teeth are completely submerged.

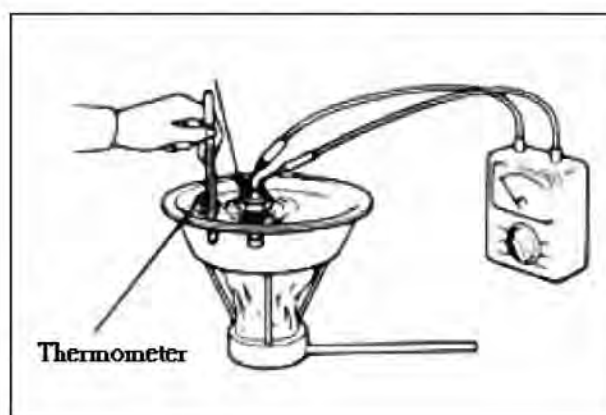
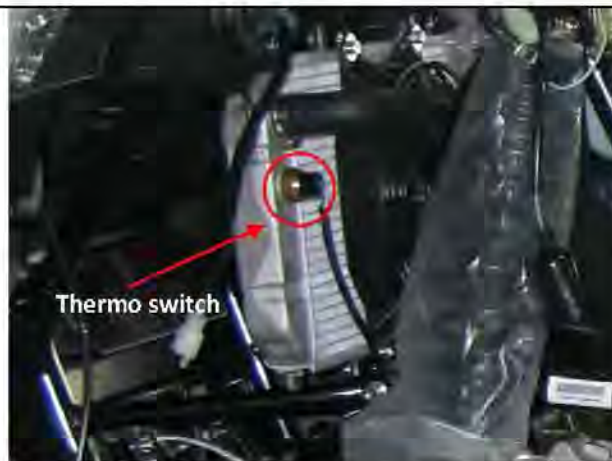

20-14. Thermo unit

Remove the thermo unit.

Hang the thermo unit in an oil heater, heat the oil and measure the resistance at each temperature.

temperature	50°C	80°C	100°C	120°C
Standard(Ω)	154	52.5	27	16

$\Omega \pm 10\%$

Caution

Wear gloves and goggles when performing this test.

Caution

Engine oil should be used as a heating medium as the test temperature must be higher than

100°C.

Contacting the container wall by the thermometer and the thermo unit may result in wrong readings.

Check the water temp indicator on the display.

- **EFI refer to 19-12**

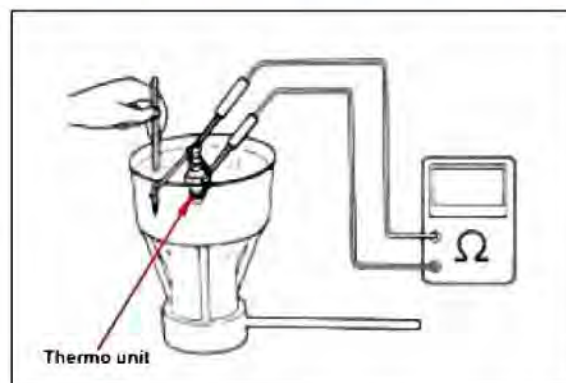

Notes:

21-01. Electrical Diagram
MAX/MAL (carburetor)

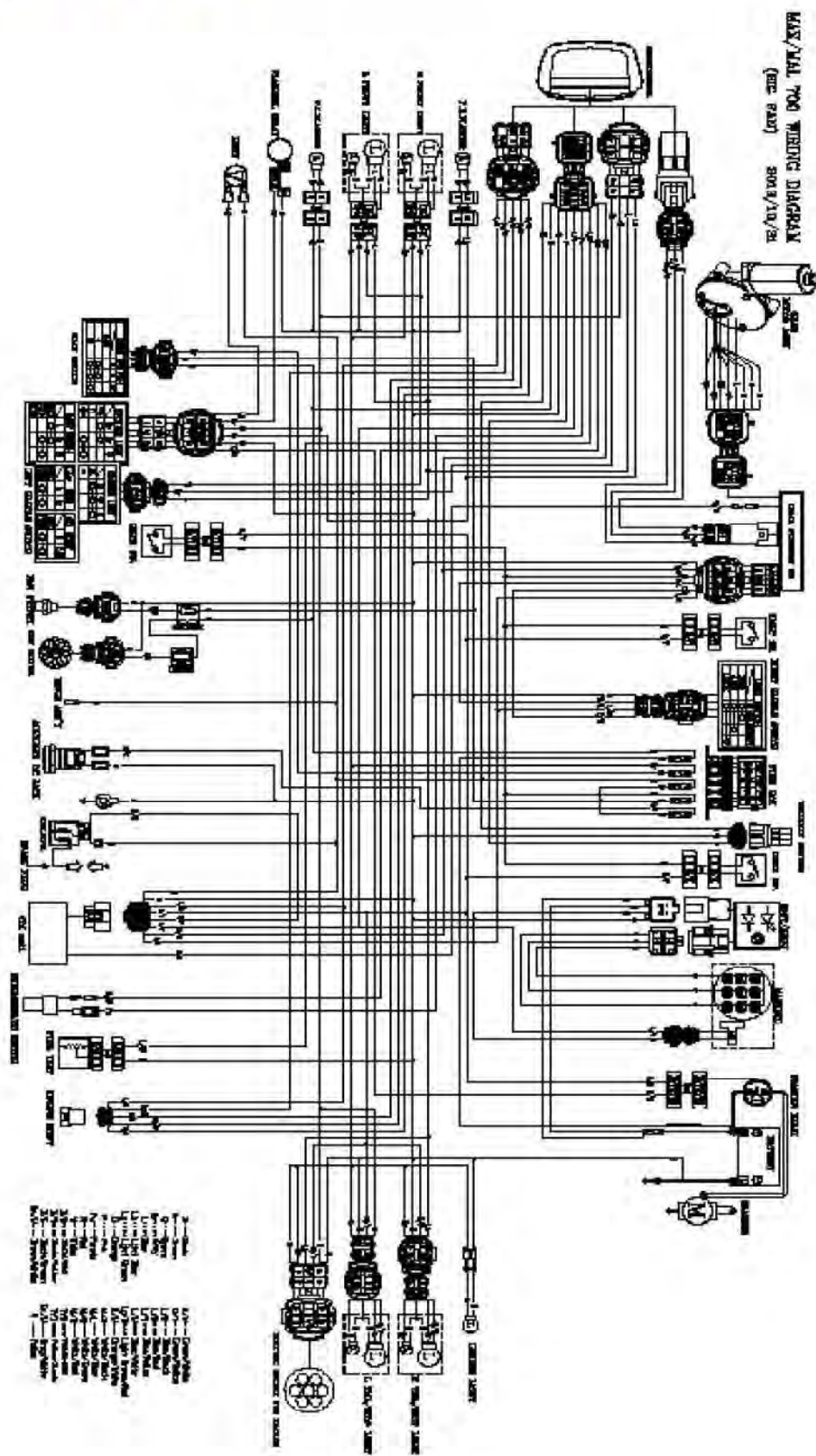

MBX (carburetor)

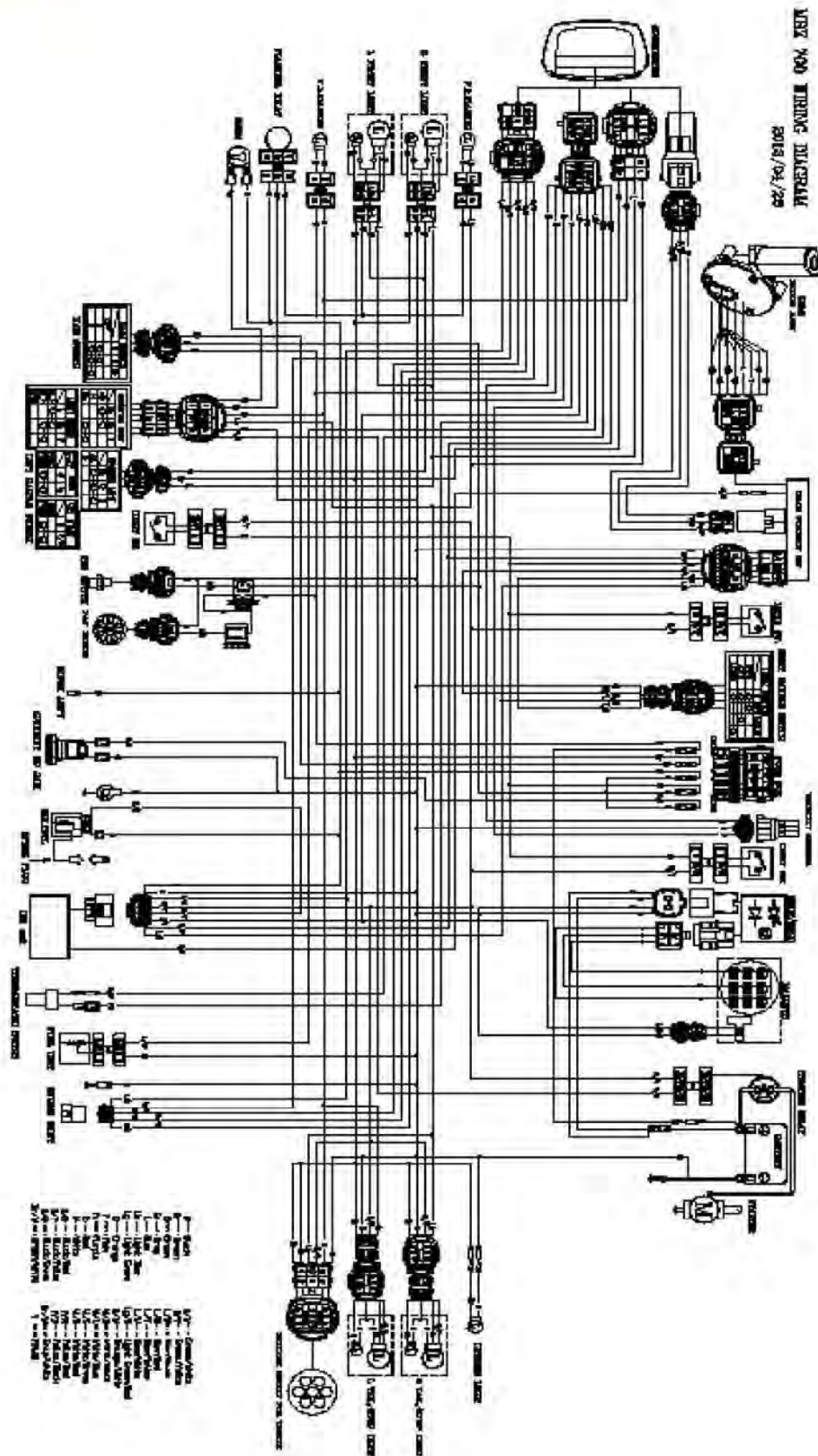

MAX/MAL (lof)

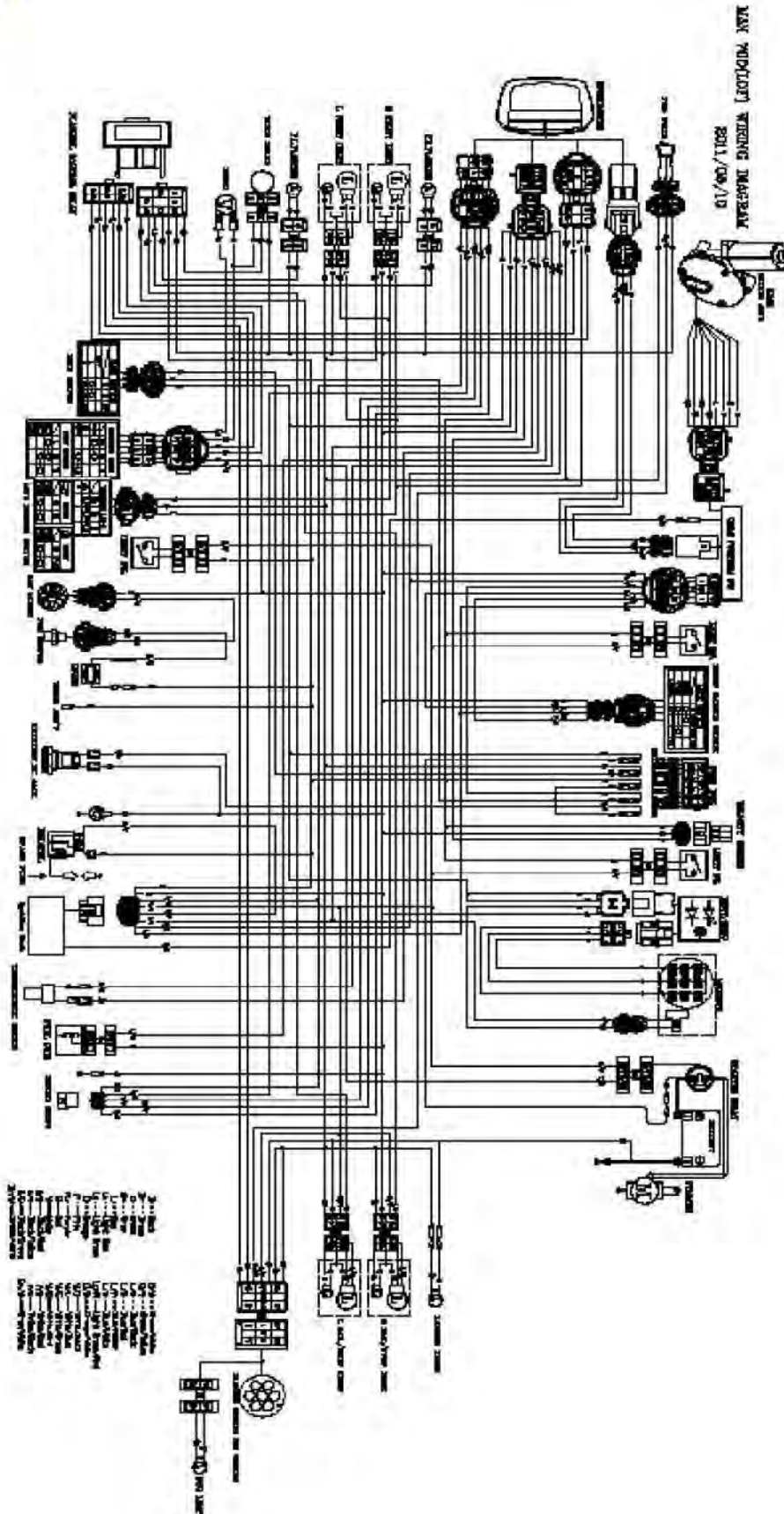

MAX/MAL (EFI)

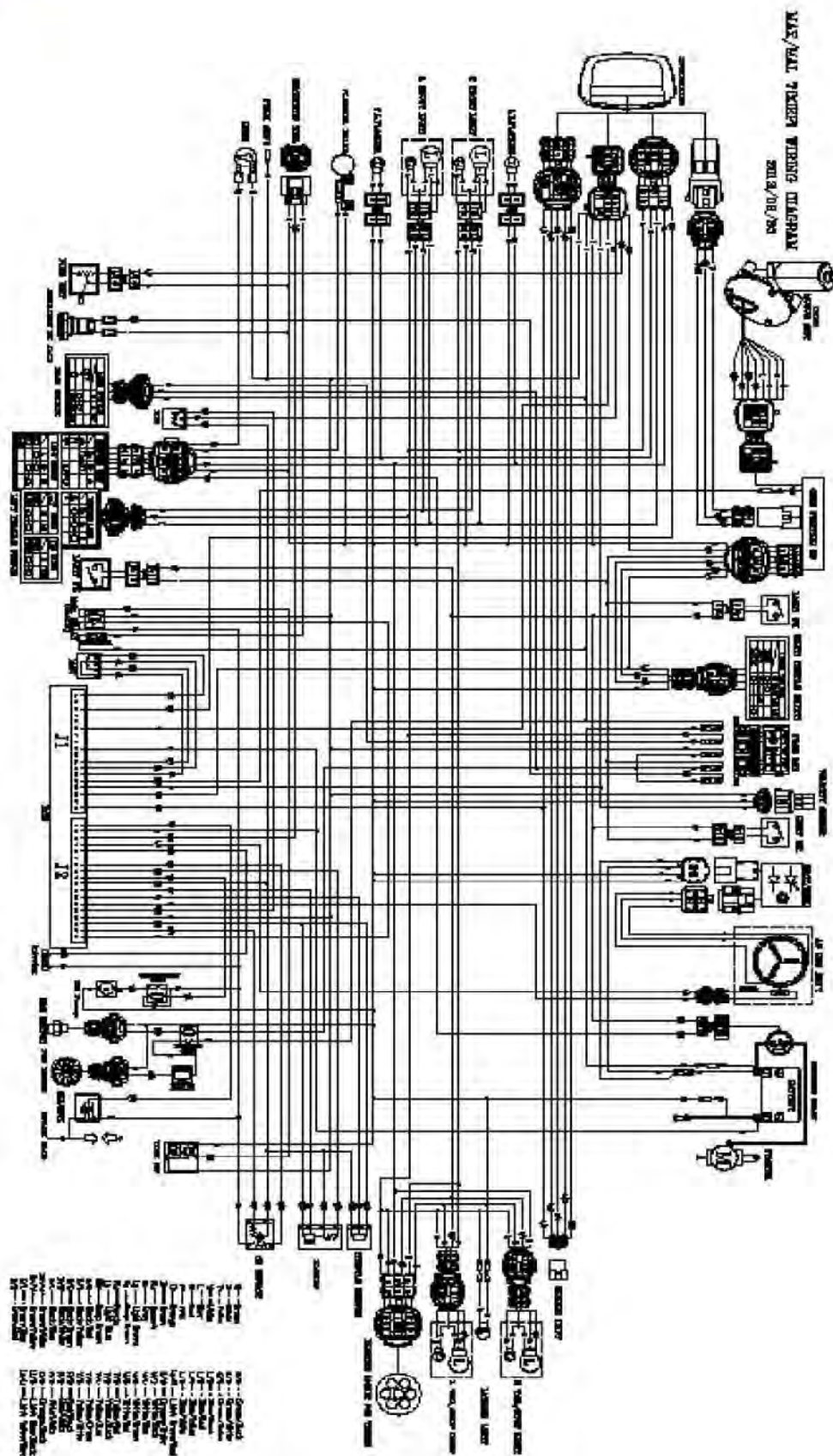

MBX (EFI)

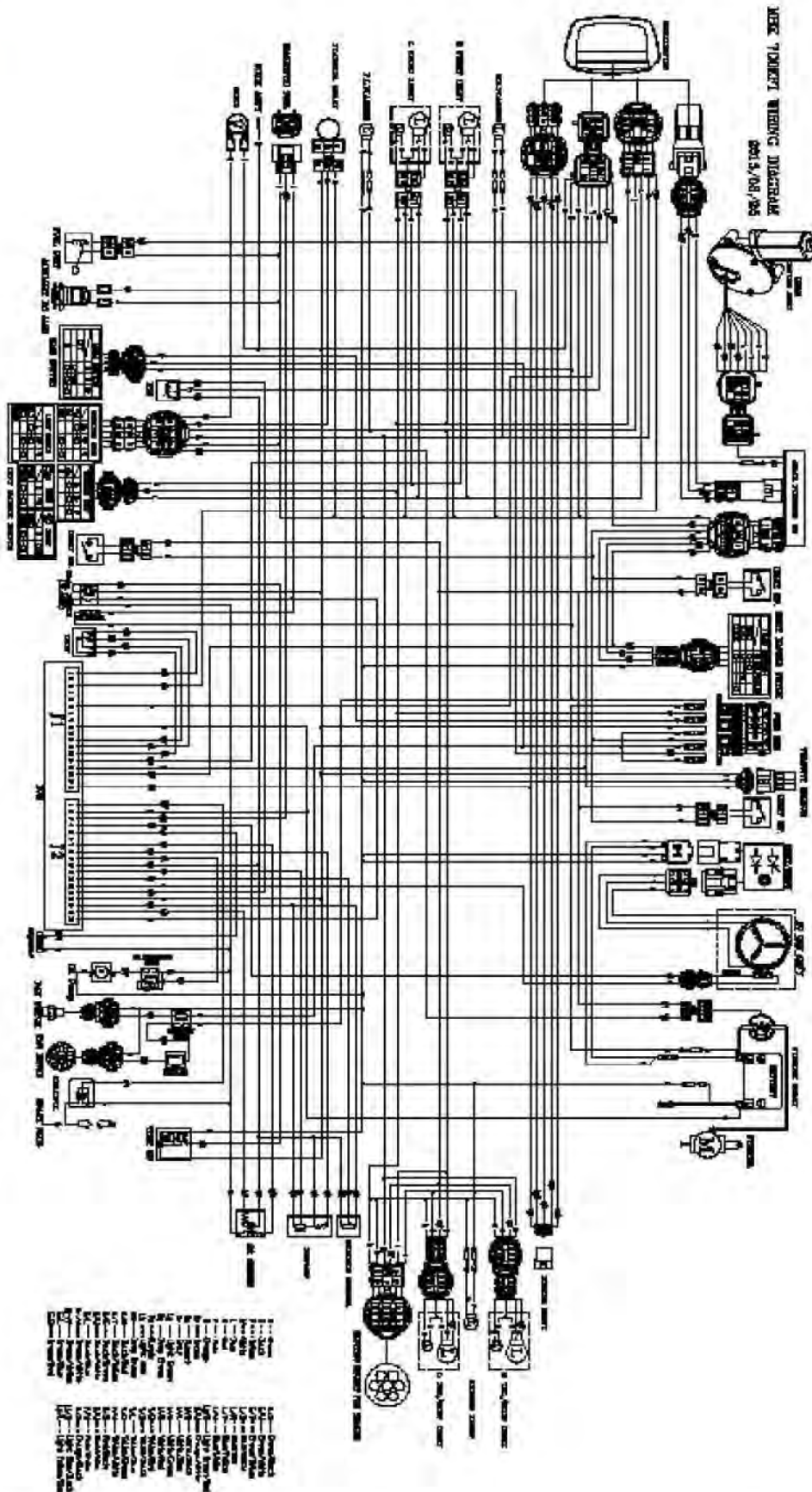

Notes: