

# PREFACE

This Service Manual describes the technical features and servicing procedures for the KYMCO  
***SUPER 8 50***

Section 1 contains the precautions for all operations stated in this manual. Read them carefully before starting any operation.

Section 2 is the removal/installation procedures for the frame covers which are subject to higher removal/installation frequency during maintenance and servicing operations.

Section 3 describes the inspection/adjustment procedures, safety rules and service information for each part, starting from periodic maintenance.

Sections 6 through 17 give instructions for disassembly, assembly and inspection of engine, chassis frame and electrical equipment.

Most sections start with an assembly or system illustration and troubleshooting for the section. The subsequent pages give detailed procedures for the section.

Our company reserves the right to make any alteration in the design. The information and contents included in this manual may be different from the motorcycle in case specifications are changed.

## TABLE OF CONTENTS

ENGINE	GENERAL INFORMATION	1
	FRAME COVERS/EXHAUST MUFFLER	2
	INSPECTION/ADJUSTMENT	3
	LUBRICATION SYSTEM	4
	FUEL SYSTEM	5
	ENGINE REMOVAL/INSTALLATION	6
	CYLINDER HEAD/VALVES	7
	CYLINDER/PISTON	8
	DRIVE AND DRIVEN PULLEYS	9
	FINAL REDUCTION	10
	CRANKCASE/CRANKSHAFT	11
CHASSIS	FRONT WHEEL/FRONT BRAKE/ FRONT SUSPENSION	12
	REAR WHEEL /REAR BRAKE /REAR SUSPENSION	13
ELECTRICAL EQUIPMENT	BATTERY/CHARGING SYSTEM/A.C. GENERATOR	14
	IGNITION SYSTEM	15
	STARTING SYSTEM	16
	LIGHTS/INSTRUMENTS/SWITCHES	17
	EXHAUST EMISSION CONTROL SYSTEM	18

**KWANG YANG MOTOR CO., LTD.**  
**OVERSEAS SALES DEPARTMENT**  
**OVERSEAS SERVICE SECTION**

---

# 1. GENERAL INFORMATION

**1**

ENGINE SERIAL NUMBER .....	1- 1	LUBRICATION POINTS.....	1-13
SPECIFICATIONS.....	1- 2	CABLE & HARNESS ROUTING.....	1-15
SERVICE PRECAUTIONS .....	1- 3	WIRING DIAGRAM .....	1-20
TORQUE VALUES .....	1-11	TROUBLESHOOTUNG.....	1-21
SPECIAL TOOLS .....	1-12		

## ENGINE SERIAL NUMBER



Frame Serial Number



Location of Engine Serial Number

# 1. GENERAL INFORMATION

## SPECIFICATIONS

Motorcycle Name & Type		SUPER 8 50		
Name & Model No.		KP10BA(AAB6)		
Overall length (mm)		2040		
Overall width (mm)		740		
Overall height (mm)		1140		
Wheel base (mm)		1365		
Engine type		Air cooled 4-stroke		
Displacement		50cc		
Fuel Used		92# nonleaded gasoline		
Net weight (kg)	Front wheel	45		
	Rear wheel	67		
	Total	112		
Max weight(kg)	Front wheel	861		
	Rear wheel	176		
	Total	262		
Tires	Front wheel	120/70 -14		
	Rear wheel	120/80 -14		
Ground clearance (mm)		130		
Performance	Braking distance (m)	2.0 (Initial speed 30km/h)		
	Min. turning radius (mm)	L:2060/R:2050		
Engine	Starting system		Starting motor	
	Type		Gasoline, 4-stroke	
	Cylinder arrangement		Single cylinder	
	Combustion chamber type		Semi-sphere	
	Valve arrangement		O.H.C.	
	Bore x stroke (mm)		∅ 39*41.4	
	Compression ratio		10.5	
	Compression pressure (kg/cm <sup>2</sup> -rpm)		16±2	
	Max. output		2.4kw/7500rpm	
	Max. torque		3.2NM/6000rpm	
	Port timing	Intake	Open	-4°
			Close	12°
		Exhaust	Open	20°
			Close	-8°
	Valve clearance (cold) (mm)	Intake	0.04	
		Exhaust	0.04	
	Idle speed (rpm)		2000rpm	
	Lubrication System	Lubrication type		OIL PUMP
		Oil pump type		Cycloid type
		Oil filter type		Full-flow filtration
		Oil capacity		0.7 liter
	Cooling Type		Forced air cooling	

Fuel System	Air cleaner type & No		Paper element	
	Fuel capacity		6.0 liter	
	Carburetor	Type	-----	
		Piston dia. (mm)	-----	
Venturi dia.(mm)		--		
Throttle type				
Electrical Equipment	Ignition System	Type	ECU	
		Ignition timing	BTDC 13 °~ 28 °	
		Contact breaker	Non-contact point type	
		Spark plug	NGK CR7HSA	
	Spark plug gap	0.6~0.7mm		
Battery	Capacity	12V8AH		
Power Drive System	Clutch	Type	Dry centrifugal type	
		Transmission Gear	CVT	
	Reduction Gear	Operation	Stepless automatic transmission	
		Type	Two-stage reduction	
		Reduction ratio	1st	0.8-3.1
		2nd	11.05	
Moving Device	Front Axle	Caster angle	27°	
		Trail length	—	
	Tire pressure (kg/cm <sup>2</sup> )	Front	1.75	
		Rear	2.25	
	Turning angle	Left	45°	
Right		45°		
Brake system type		Front	DISK	
		Rear	Drum	
Damping Device	Suspension type	Front	FR:TELESCOPE	
		Rear	RR:UNIT SWING	
	Shock absorber distance	Front	80	
Rear		82		
Frame type		Pipe Under Bone		

0.04  
0.04  
2000rpm  
2000rpm

Forced air cooling

# 1. GENERAL INFORMATION

## SERVICE PRECAUTIONS

- Make sure to install new gaskets, O-rings, circlips, cotter pins, etc. when reassembling.

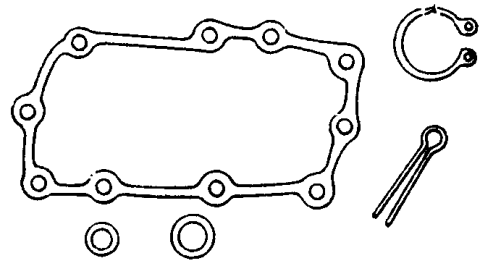

- When tightening bolts or nuts, begin with larger-diameter to smaller ones at several times, and tighten to the specified torque diagonally.

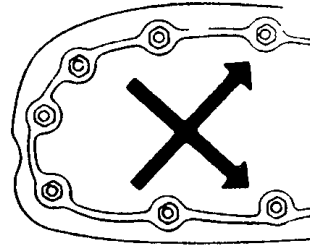

- Use genuine parts and lubricants

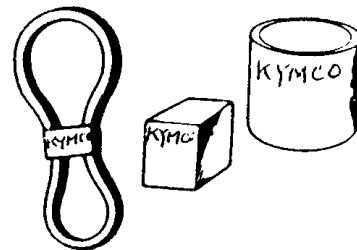

- When servicing the motorcycle, be sure to use special tools for removal and installation.

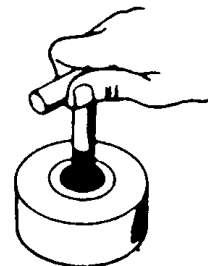

- After disassembly, clean removed parts. Lubricate sliding surfaces with engine oil before reassembly.

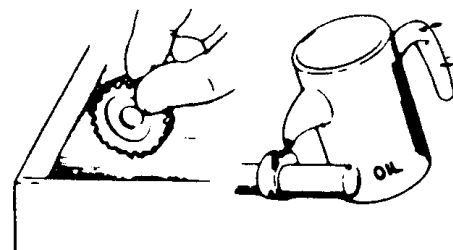

# 1. GENERAL INFORMATION

- Apply or add designated greases and lubricants to the specified lubrication points.

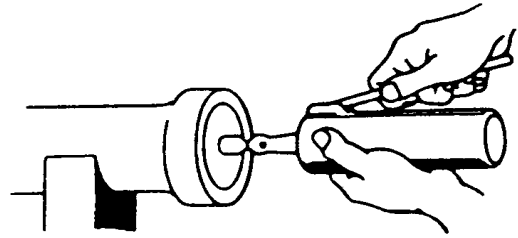

- After reassembly, check all parts for proper tightening and operation.

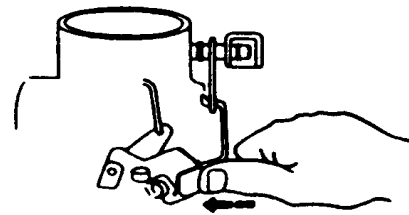

- When two persons work together, pay attention to the mutual working safety.

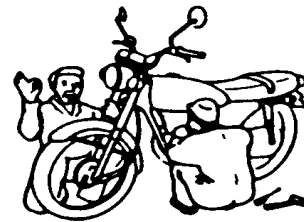

- Disconnect the battery negative (-) terminal before operation.
- When using a spanner or other tools, make sure not to damage the motorcycle surface.

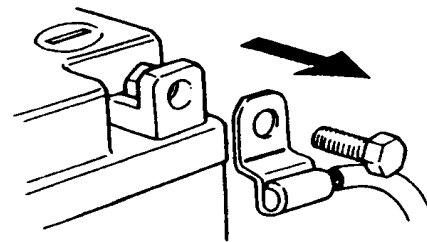

- After operation, check all connecting points, fasteners, and lines for proper connection and installation.
- When connecting the battery, the positive (+) terminal must be connected first.
- After connection, apply grease to the battery terminals.
- Terminal caps shall be installed securely.

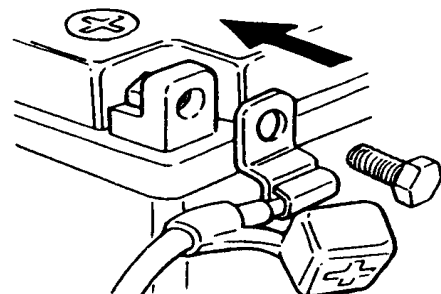

# 1. GENERAL INFORMATION

- If the fuse is burned out, find the cause and repair it. Replace it with a new one according to the specified capacity.

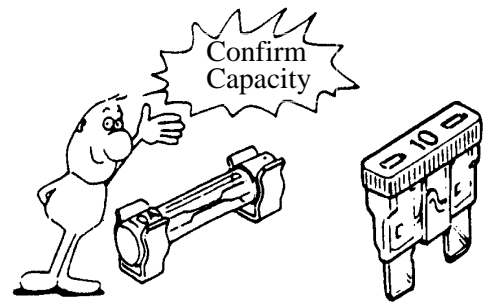

- After operation, terminal caps shall be installed securely.

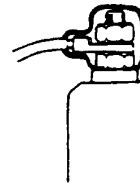

- When taking out the connector, the lock on the connector shall be released before operation.

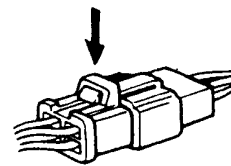

- Hold the connector body when connecting or disconnecting it.
- Do not pull the connector wire.



- Check if any connector terminal is bending, protruding or loose.

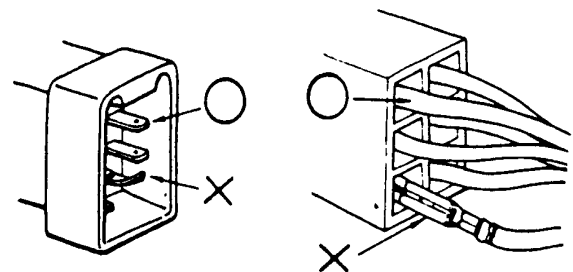

# 1. GENERAL INFORMATION

- The connector shall be inserted completely.
- If the double connector has a lock, lock it at the correct position.
- Check if there is any loose wire.

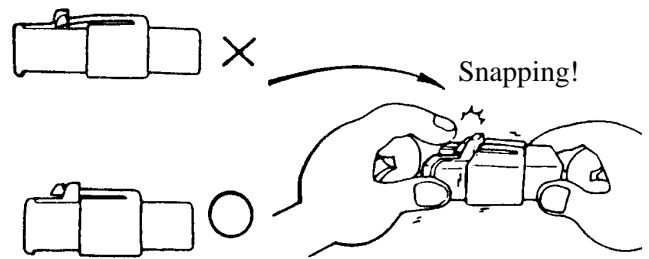

- Before connecting a terminal, check for damaged terminal cover or loose negative terminal.

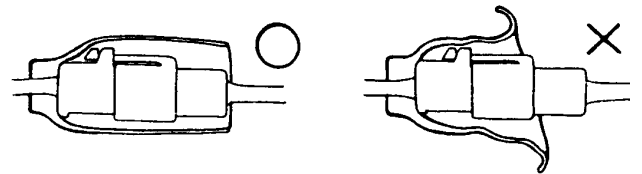

- Check the double connector cover for proper coverage and installation.

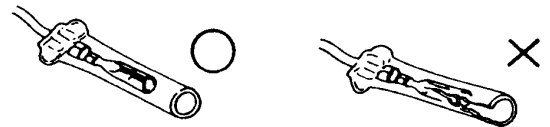

- Insert the terminal completely.
- Check the terminal cover for proper coverage.
- Do not make the terminal cover opening face up.

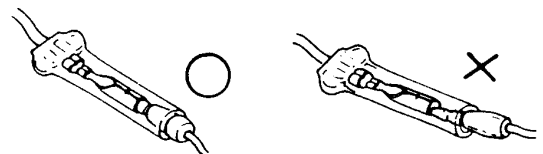

- Secure wire harnesses to the frame with their respective wire bands at the designated locations. Tighten the bands so that only the insulated surfaces contact the wire harnesses.

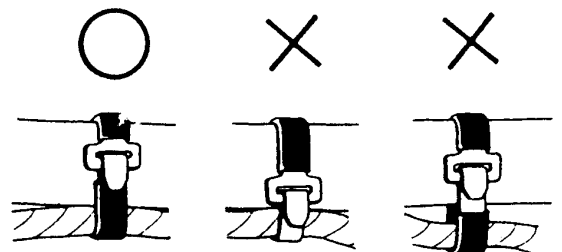

# 1. GENERAL INFORMATION

- After clamping, check each wire to make sure it is secure.

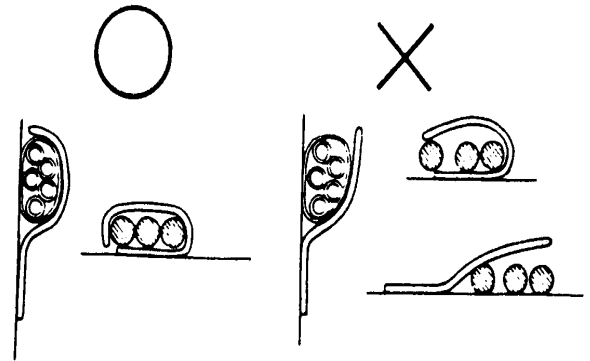

- Do not squeeze wires against the weld or its clamp



- After clamping, check each harness to make sure that it is not interfering with any moving or sliding parts.

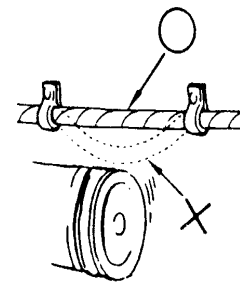

- When fixing the wire harnesses, do not make it contact the parts which will generate high heat.

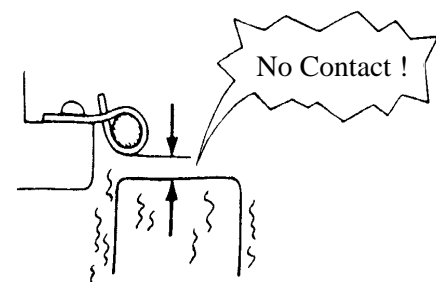

- Route wire harnesses to avoid sharp edges or corners. Avoid the projected ends of bolts and screws.
- Route wire harnesses passing through the side of bolts and screws. Avoid the projected ends of bolts and screws.

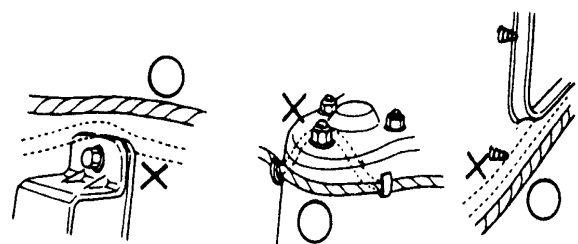



# 1. GENERAL INFORMATION

- Route harnesses so they are neither pulled tight nor have excessive slack.

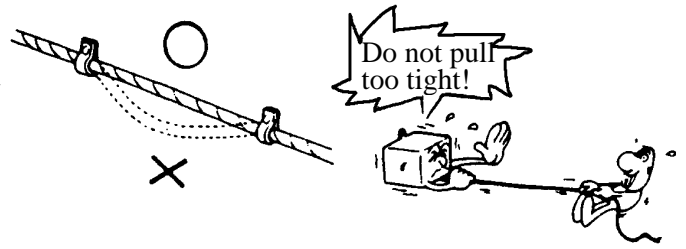

- Protect wires and harnesses with electrical tape or tube if they contact a sharp edge or corner

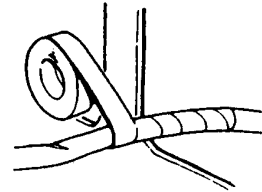

- When rubber protecting cover is used to protect the wire harnesses, it shall be installed securely.

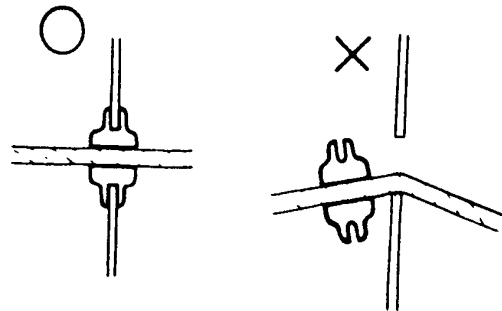

- Do not break the sheath of wire.
- If a wire or harness is with a broken sheath, repair by wrapping it with protective tape or replace it.

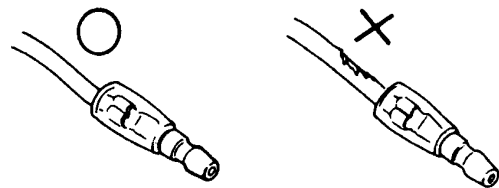

- When installing other parts, do not press or squeeze the wires.

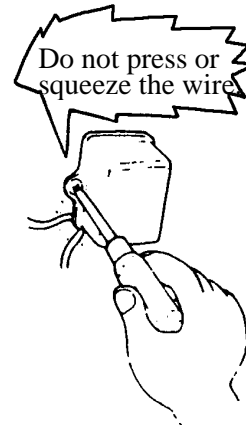

# 1. GENERAL INFORMATION

- After routing, check that the wire harnesses are not twisted or kinked.

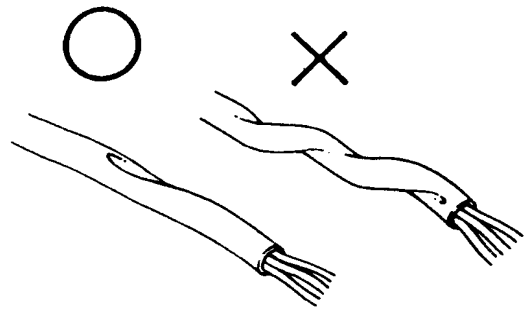

- Wire harnesses routed along with handlebar should not be pulled tight, have excessive slack or interfere with adjacent or surrounding parts in all steering positions.

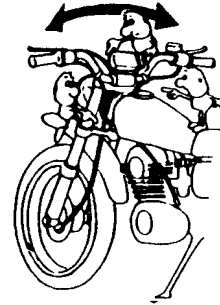

- When a testing device is used, make sure to understand the operating methods thoroughly and operate according to the operating instructions.

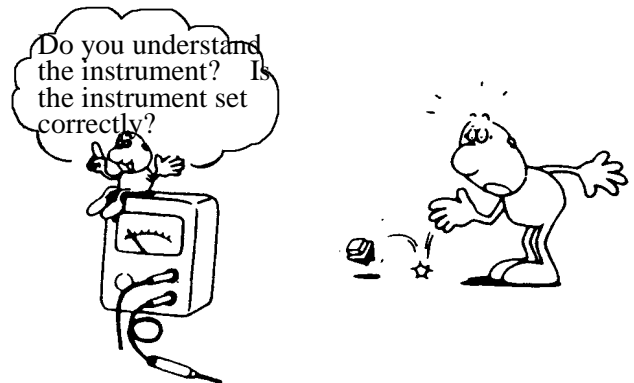

- Be careful not to drop any parts.

- When rust is found on a terminal, remove the rust with sand paper or equivalent before connecting.

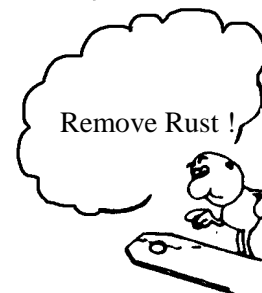

- Do not bend or twist control cables. Damaged control cables will not operate smoothly and may stick or bind.

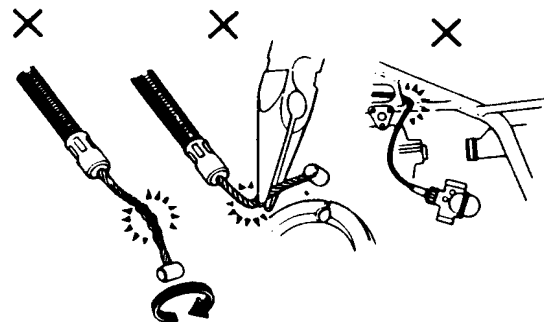

# 1. GENERAL INFORMATION

## ■ Symbols:

The following symbols represent the servicing methods and cautions included in this service manual.



Engine Oil

: Apply engine oil to the specified points. (Use designated engine oil for lubrication.)



Grease

: Apply grease for lubrication.



Gear Oil

: Transmission Gear Oil (90#)



: Use special tool.



: Caution



: Warning

(⇒12-3) : Refer to page 12-3.

# 1. GENERAL INFORMATION

**SUPER 8 50**

## TORQUE VALUES

### STANDARD TORQUE VALUES

Item	Torque (kg-m)	Item	Torque (kg-m)
5mm bolt, nut	0.45-0.6	5mm screw	0.35-0.5
6mm bolt, nut	0.6-1.2	6mm screw, SH bolt	0.7-1.1
8mm bolt, nut	1.8-2.5	6mm flange bolt, nut	1.0-1.4
10mm bolt, nut	3.0-4.0	8mm flange bolt, nut	2.4-3.0
12mm bolt, nut	5.0-6.0	10mm flange bolt, nut	3.5-4.5

Torque specifications listed below are for important fasteners.

### ENGINE

Item	Q'ty	Thread dia.(mm)	Torque (kg-m)	Remarks
Cylinder head bolt A	2	6	0.7-1.1	Double end bolt
Cylinder head bolt B	4	6	0.7-1.1	
Oil filter screen cap	1	30	1.0-2.0	Double end bolt Apply oil to threads
Exhaust muffler lock bolt	2	6	0.7-1.1	
Cylinder head flange nut	4	7	1.2-1.6	
Valve adjusting lock nut	2	3	0.07-0.09	
Cam chain tensioner slipper bolt	1	8	0.4-0.7	
Oil bolt	1	8	1.1-1.5	
Clutch outer nut	1	10	3.5-4.5	
Clutch drive plate nut	1	28	5.0-6.0	
Starter motor mounting bolt	2	6	0.8-1.2	
Oil pump bolt	3	4	0.1-0.3	
Drive face nut	1	10	5.5-6.5	
Spark plug	1	10	1.0-1.4	
A.C. generator stator bolt	2	6	0.8-1.2	
Cam chain tensioner bolt	1	6	0.8-1.2	

### FRAME

Item	Q'ty	Thread dia.(mm)	Torque (kg-m)	Remarks
Steering stem lock nut	1	25.4	8.0-12.0	U-nut
Front axle nut	1	10	5.0-7.0	U-nut
Rear axle nut	1	14	11.0-13.0	U-nut
Rear shock absorber upper bolt	1	10	4.0-5.0	Apply locking agent
Rear shock absorber lower bolt	1	8	2.0-3.0	
Speedometer cable set screw	1	5	0.45-0.6	
Rear shock absorber lock nut	1	8	3.0-3.6	

# 1. GENERAL INFORMATION

**SUPER 8 50**

## SPECIAL TOOLS

Tool Name	Tool No.	Remarks	Ref. Page
Bearing puller 10.12.15.18 mm	E037	10.12.15.18mm bearing	10-3 10-4 12-6
Bushing remover L	E032	11102 bush engine hanger rubber	
Bushing remover S	EO19	11203 bush rear cushion under rubber	
Crankshaft bearing puller	E030	91005 radial bearing	
Crankshaft protector	E029	13000 crankshaft comp 12mm.14mm	
Clutch spring compressor	E027	2301a driven pully assy	9-9 9-12
Cushion assemble & disassemble tool	F004	52400 cushion assy	13-4
Flywheel holder	E017	31110 flywheel comp.2310a pully assy driven	9-5 9-9 9-13 14-7 14-9
Flywheel puller	E002	Left hand thread 27mm	14-7
Long socket wrench 32mm 8angle	F002	50306 steering stem	12-21 12-22
Oil seal & bearing installer	E014	Oil seal & bearing install	
Tool boox	E033	Special tools storage	
Tappet adjuster	E036	90012 screw tappet	3-5
Valve spring compressor	E038	Valve spring	7-7 7-8

# 1. GENERAL INFORMATION

**SUPER 8 50**

## LUBRICATION POINTS

### ENGINE

Lubrication Points	Lubricant
Valve guide/valve stem movable part Cam lobes Valve rocker arm friction surface Cam chain Cylinder lock bolt and nut Piston surroundings and piston ring grooves Piston pin surroundings Cylinder inside wall Connecting rod/piston pin hole Connecting rod big end Crankshaft R/L side oil seal Starter reduction gear engaging part Countershaft gear engaging part Final gear engaging part Bearing movable part O-ring face Oil seal lip	<ul style="list-style-type: none"> <li>•Genuine KYMCO Engine Oil (SAE15W-40)</li> <li>•API-SG Engine Oil</li> </ul>
Starter idle gear Friction spring movable part/shaft movable part Shaft movable grooved part Kick starter spindle movable part	High-temperature resistant grease
A.C. generator connector Transmission case breather tube	Adhesive

# 1. GENERAL INFORMATION

## FRAME

The following is the lubrication points for the frame.

Use general purpose grease for parts not listed.

Apply clean engine oil or grease to cables and movable parts not specified.

This will avoid abnormal noise and rise the durability of the motorcycle.

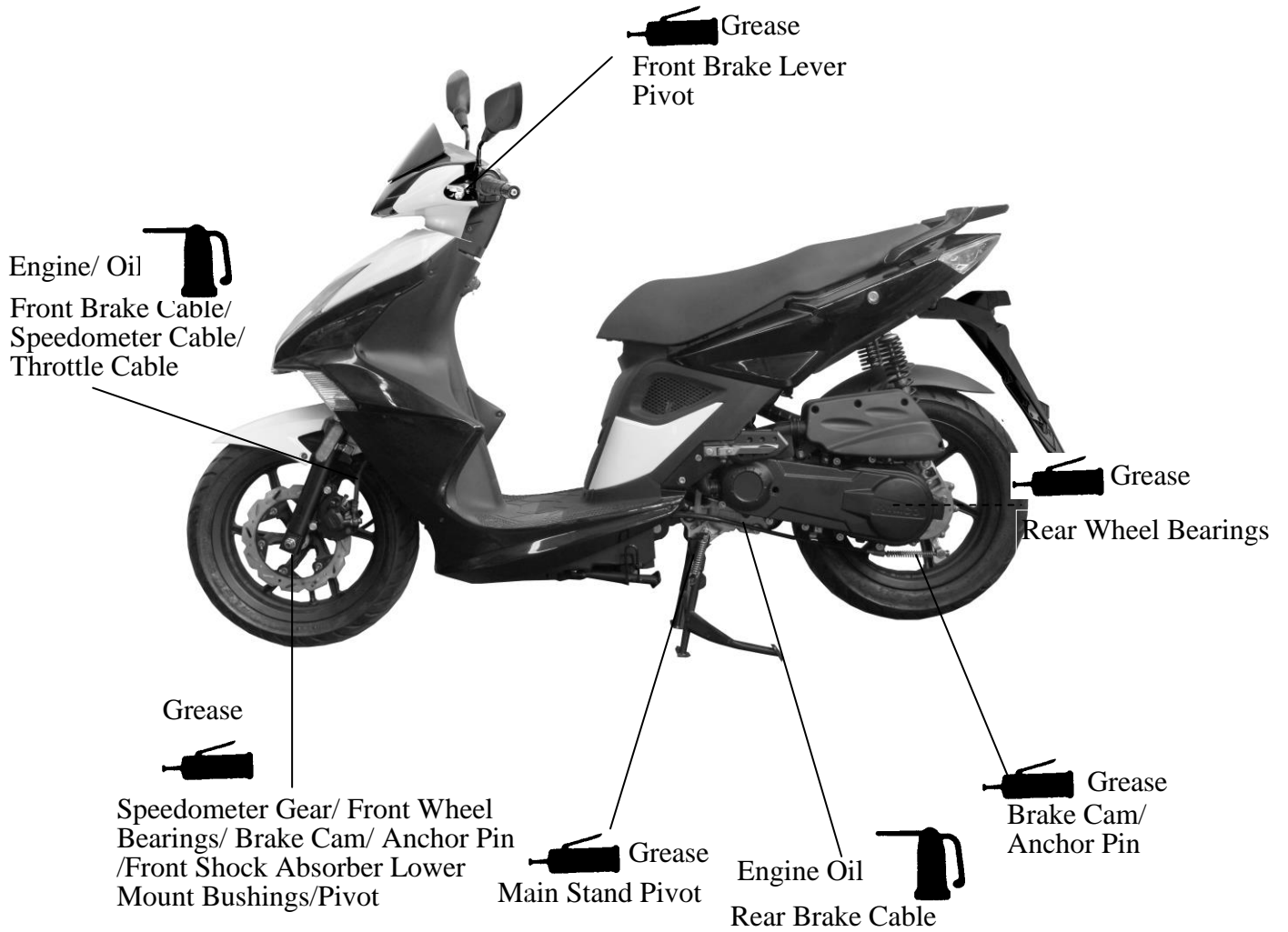

**1. GENERAL INFORMATION**

**CABLE & HARNESS ROUTING**

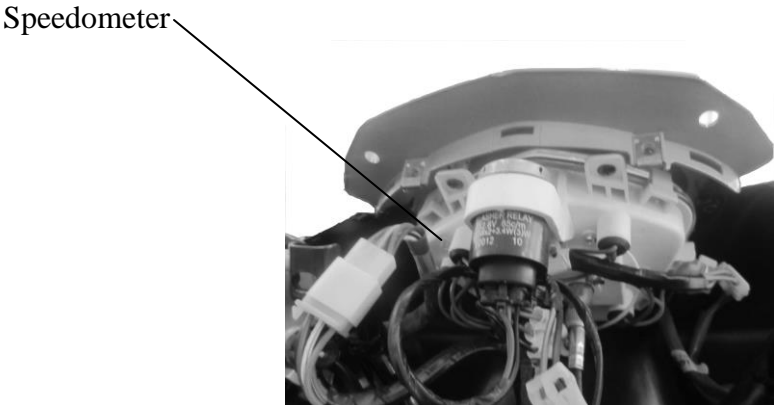
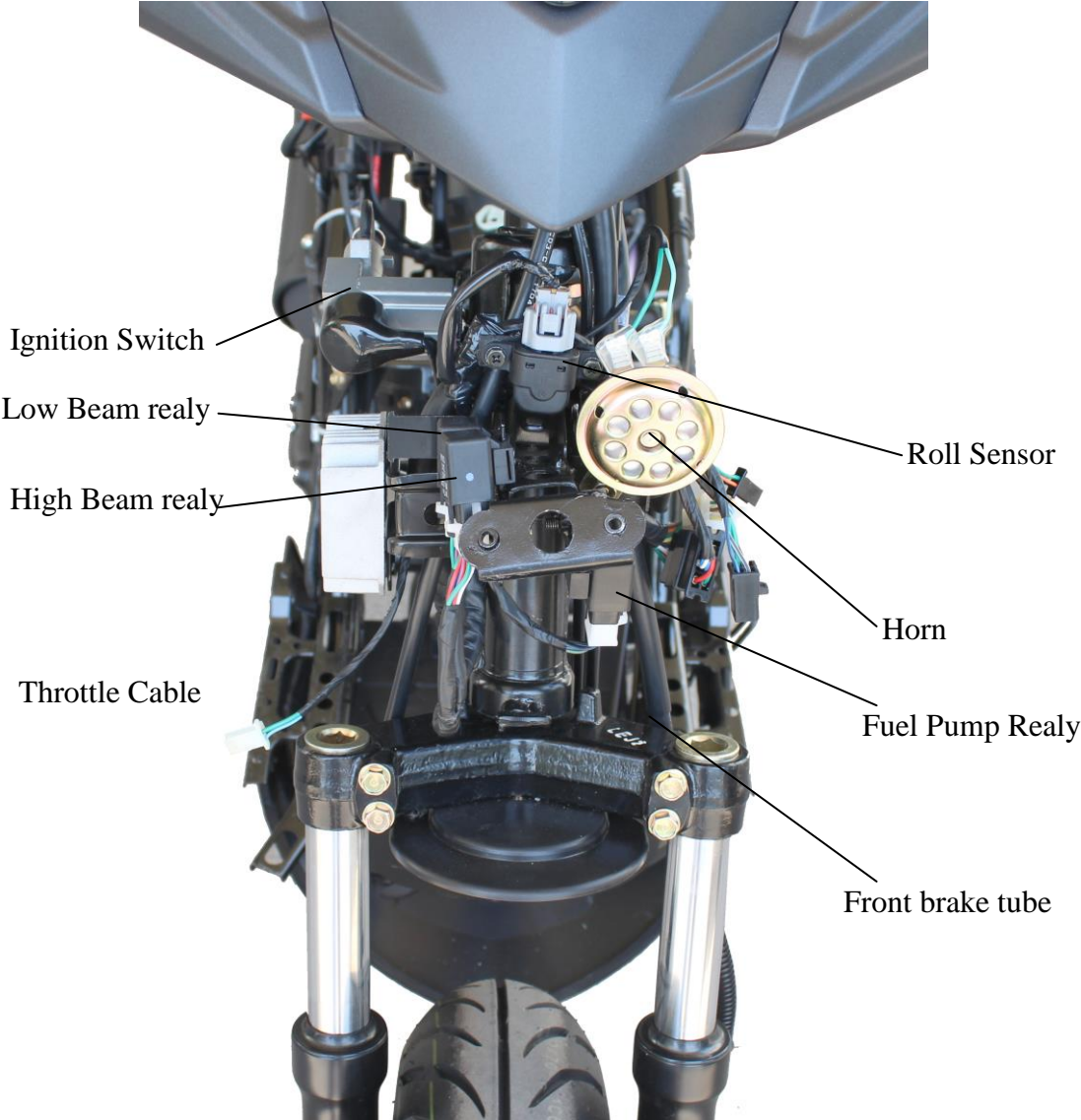





**1. GENERAL INFORMATION**

**SUPER 8 50**

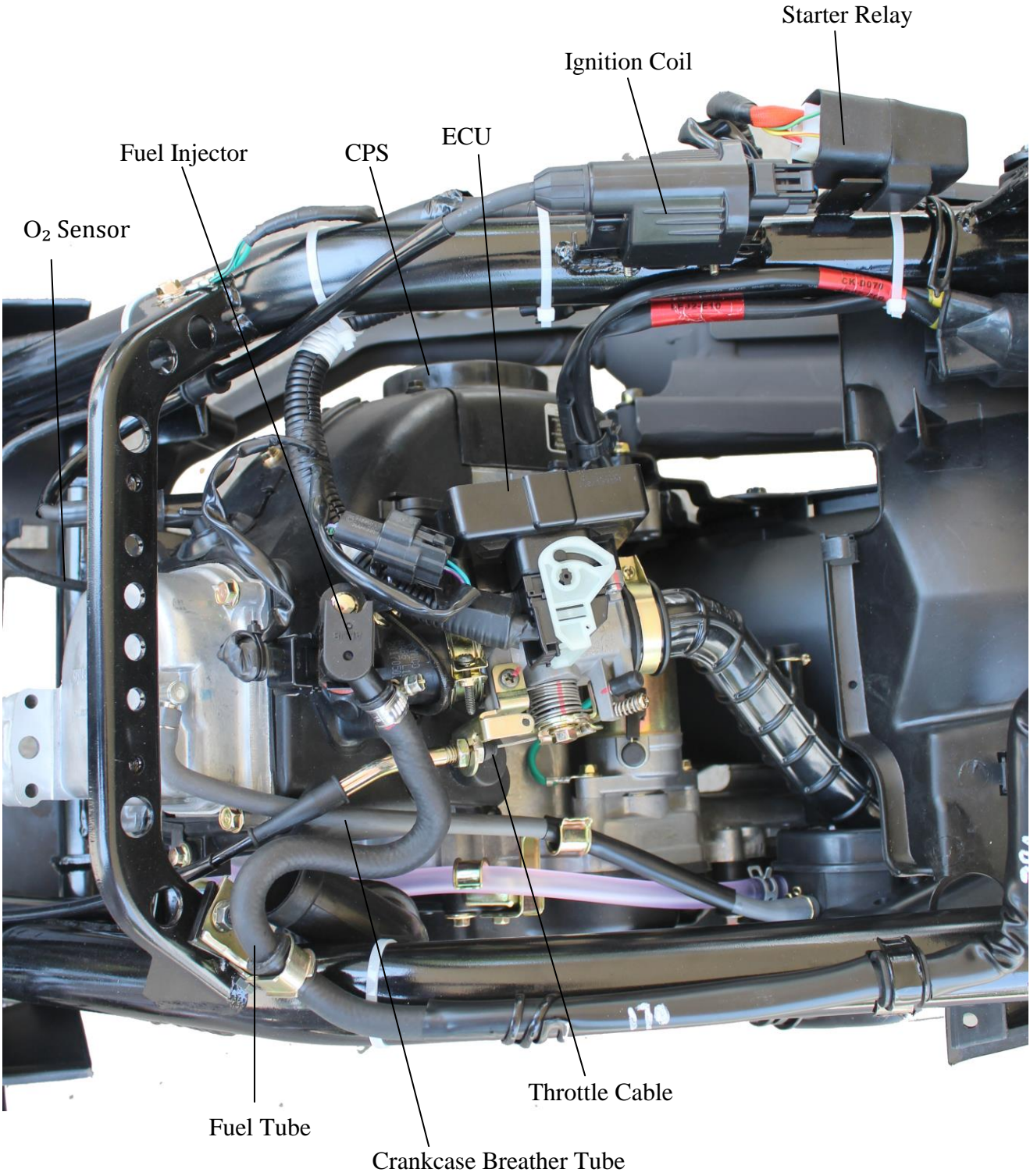



# 1. GENERAL INFORMATION

## TROUBLESHOOTING

### ENGINE WILL NOT START OR IS HARD TO START

<b>Possible cause</b>
-----------------------

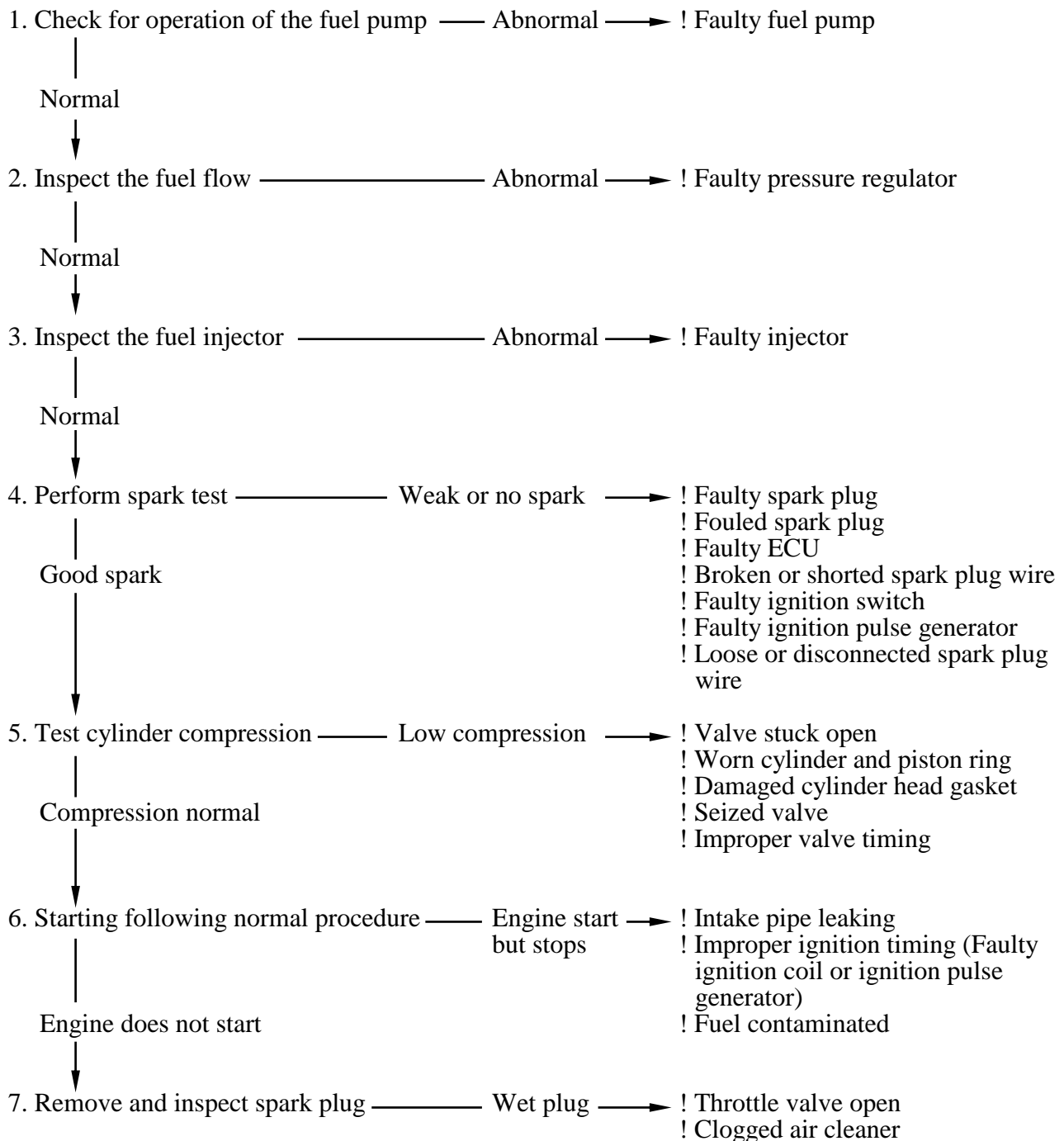

# 1. GENERAL INFORMATION

## ENGINE LACKS POWER

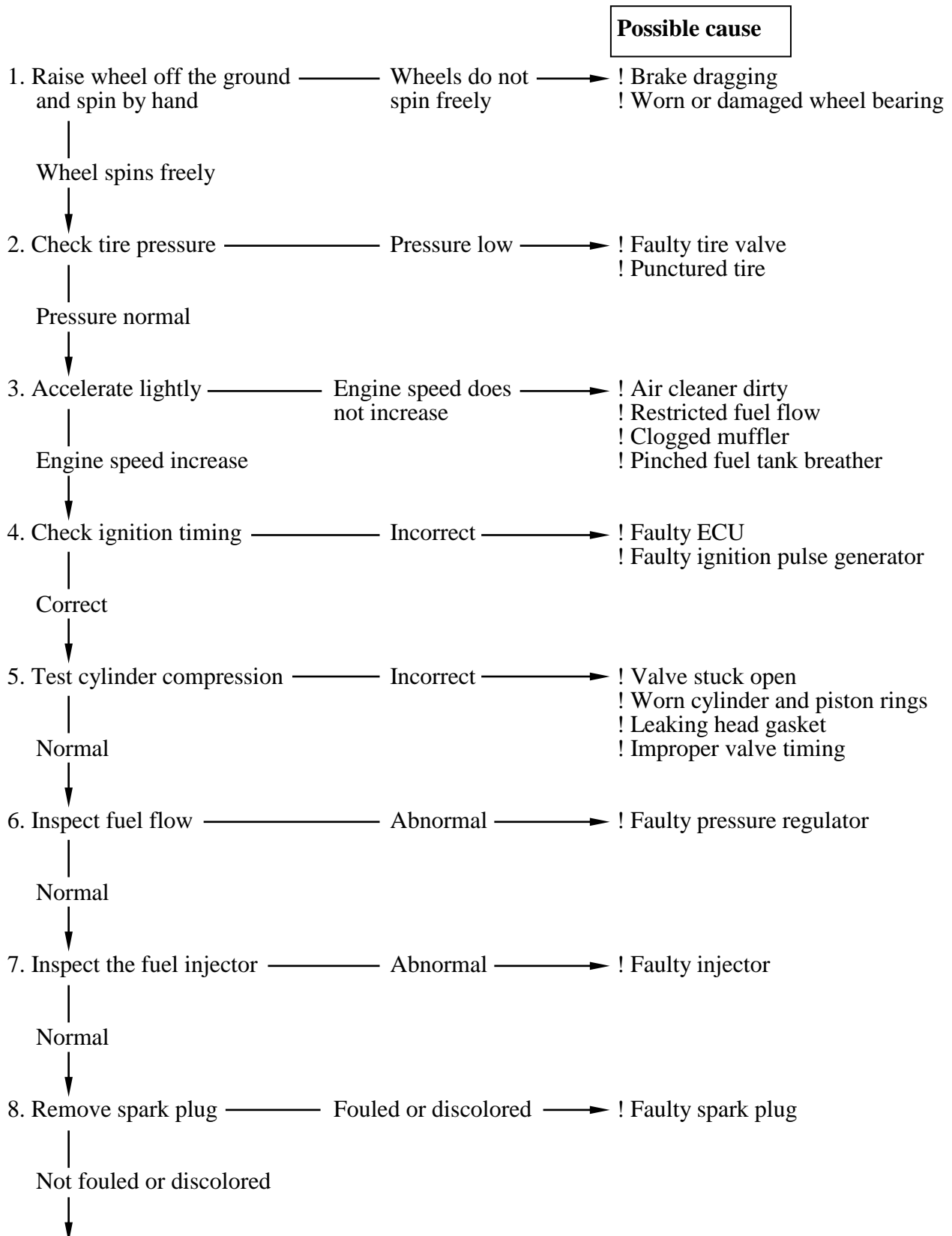

# 1. GENERAL INFORMATION

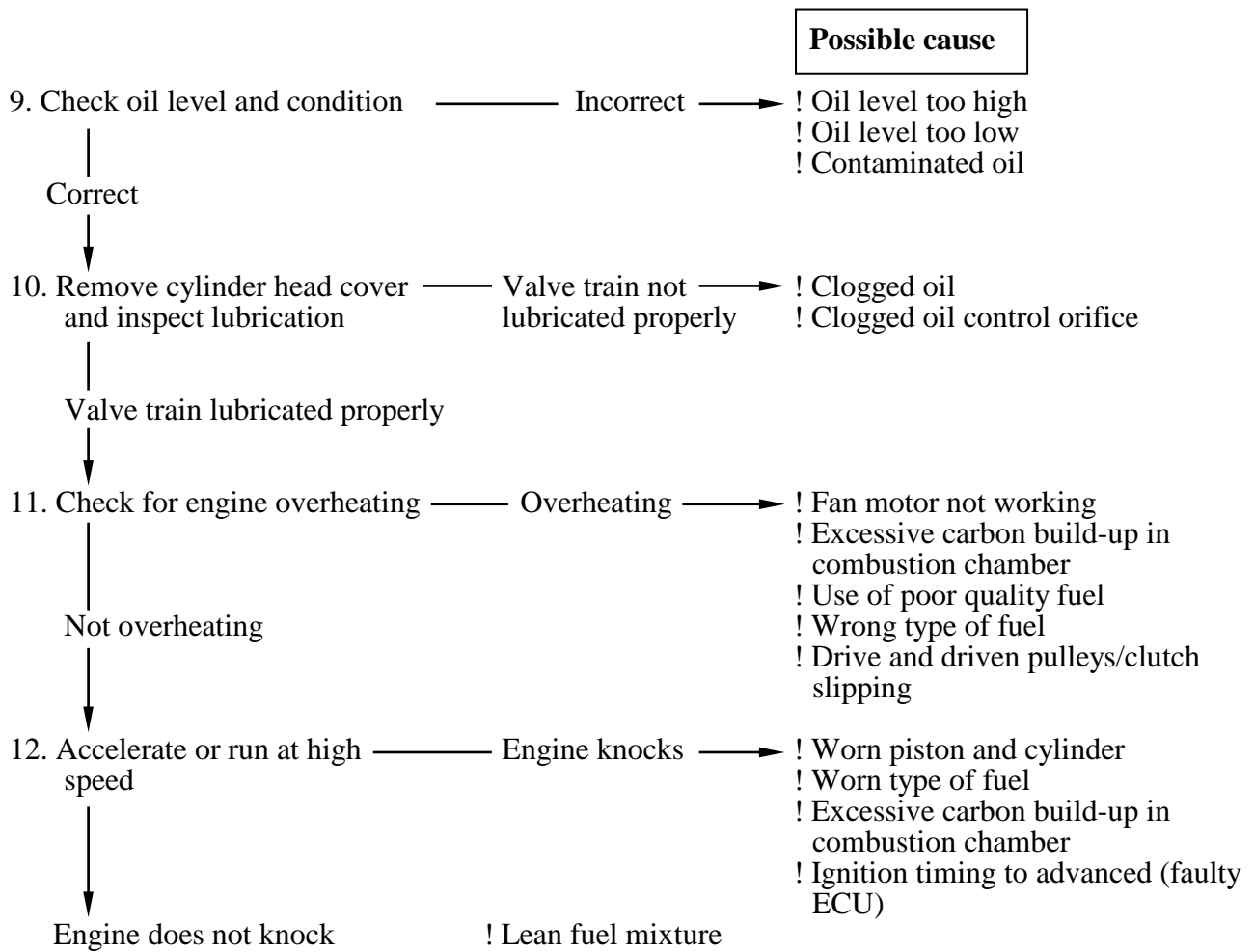
**SUPER 8 50**

# 1. GENERAL INFORMATION

## POOR PERFORMANCE AT LOW AND IDLE SPEED

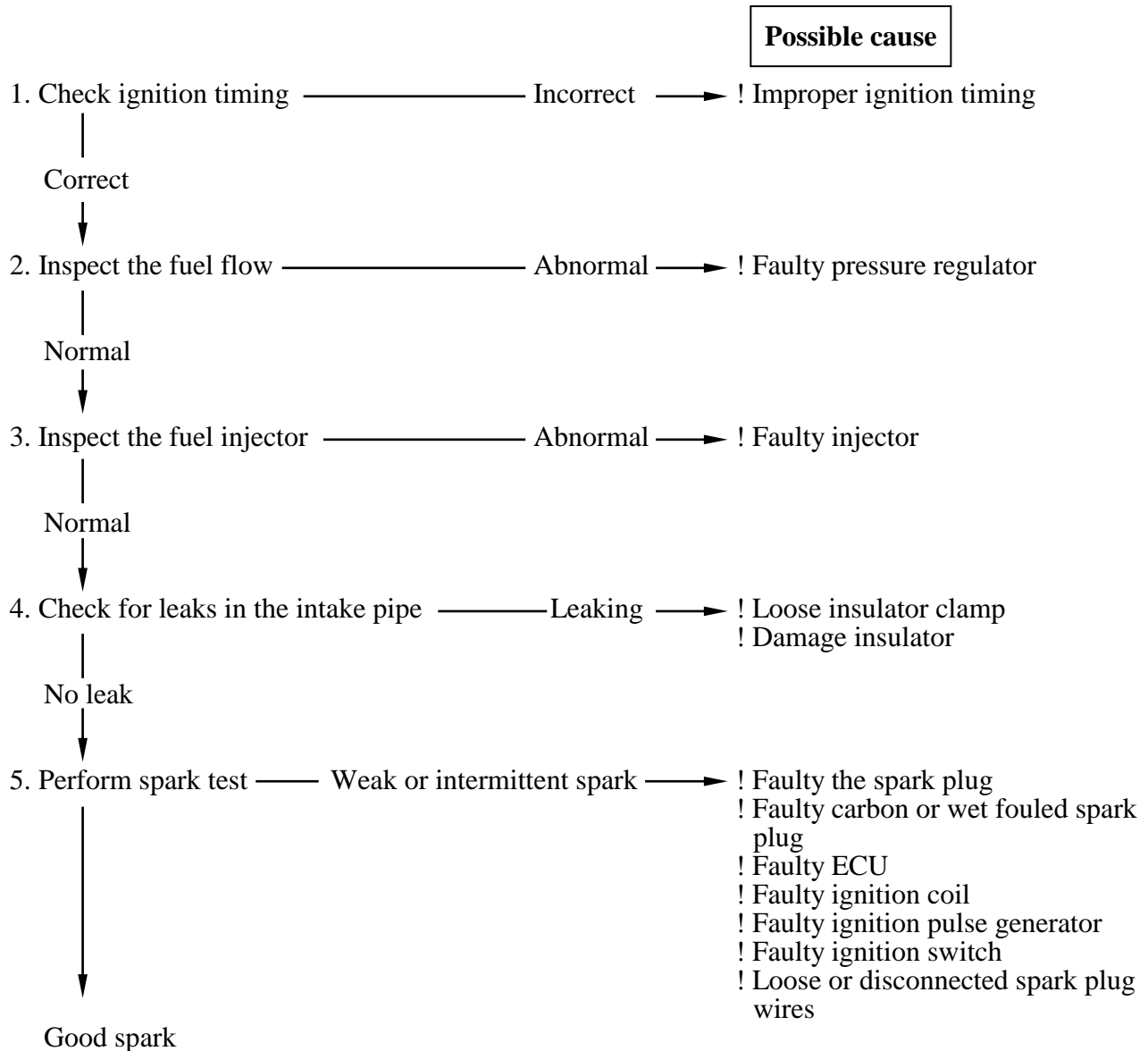

# 1. GENERAL INFORMATION

## POOR PERFORMANCE AT HIGH SPEED

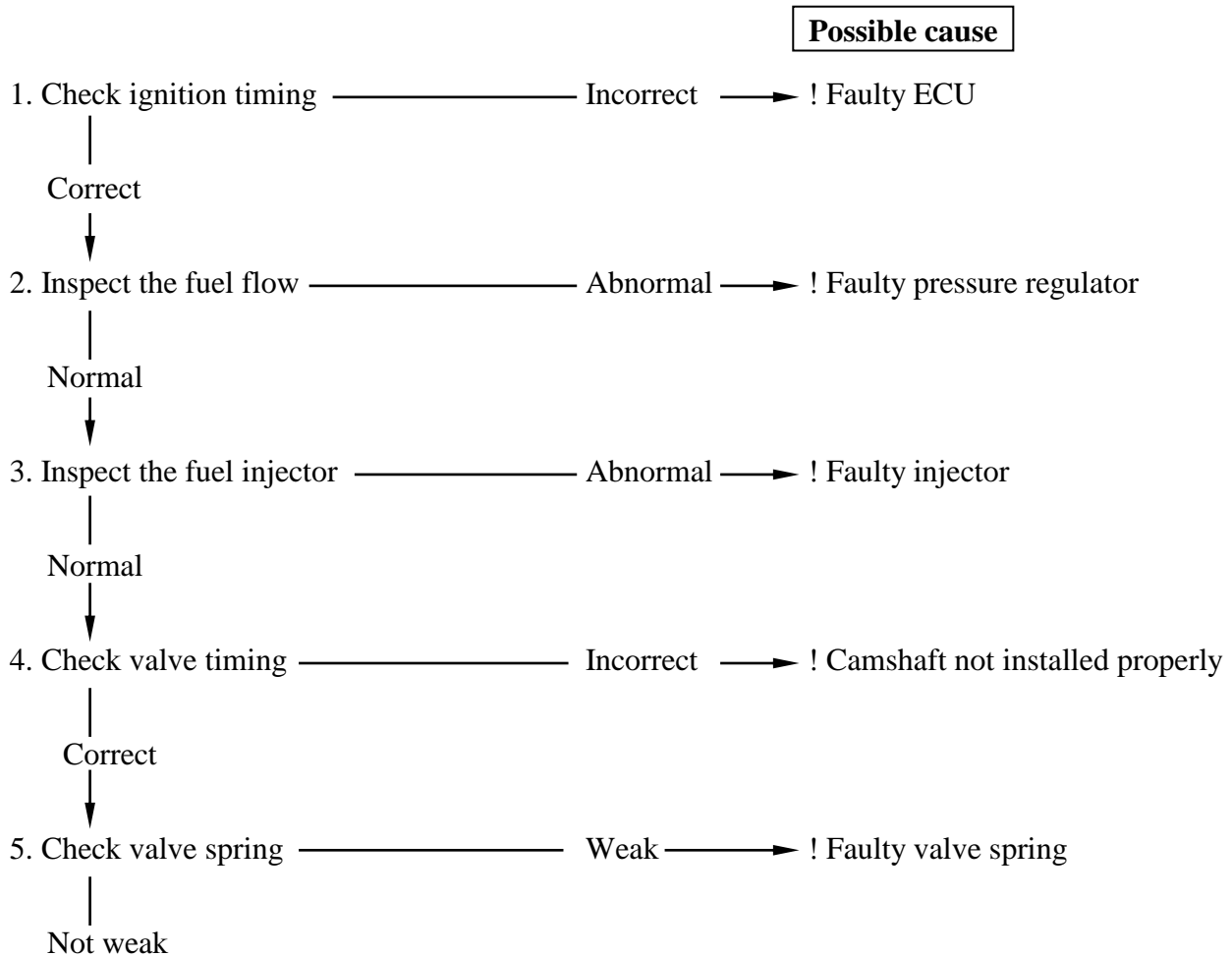

## POOR HANDLING

	<b>Possible cause</b>
1. If steering is heavy —————→	! Steering stem adjusting nut too tight ! Damaged steering head bearings
2. If either wheel is wobbling —————→	! Excessive wheel bearing play ! Bent rim ! Improper installed wheel hub ! Swing arm pivot bearing excessively worn ! Bent frame
3. If the motorcycle pulled to one side —————→	! Faulty the shock absorber ! Front and rear wheel not aligned ! Bent fork ! Bent swing arm ! Bent axle





# 2. FRAME COVERS/EXHAUST MUFFLER

NEW SUPER8 50

KP10BA(IT) F03

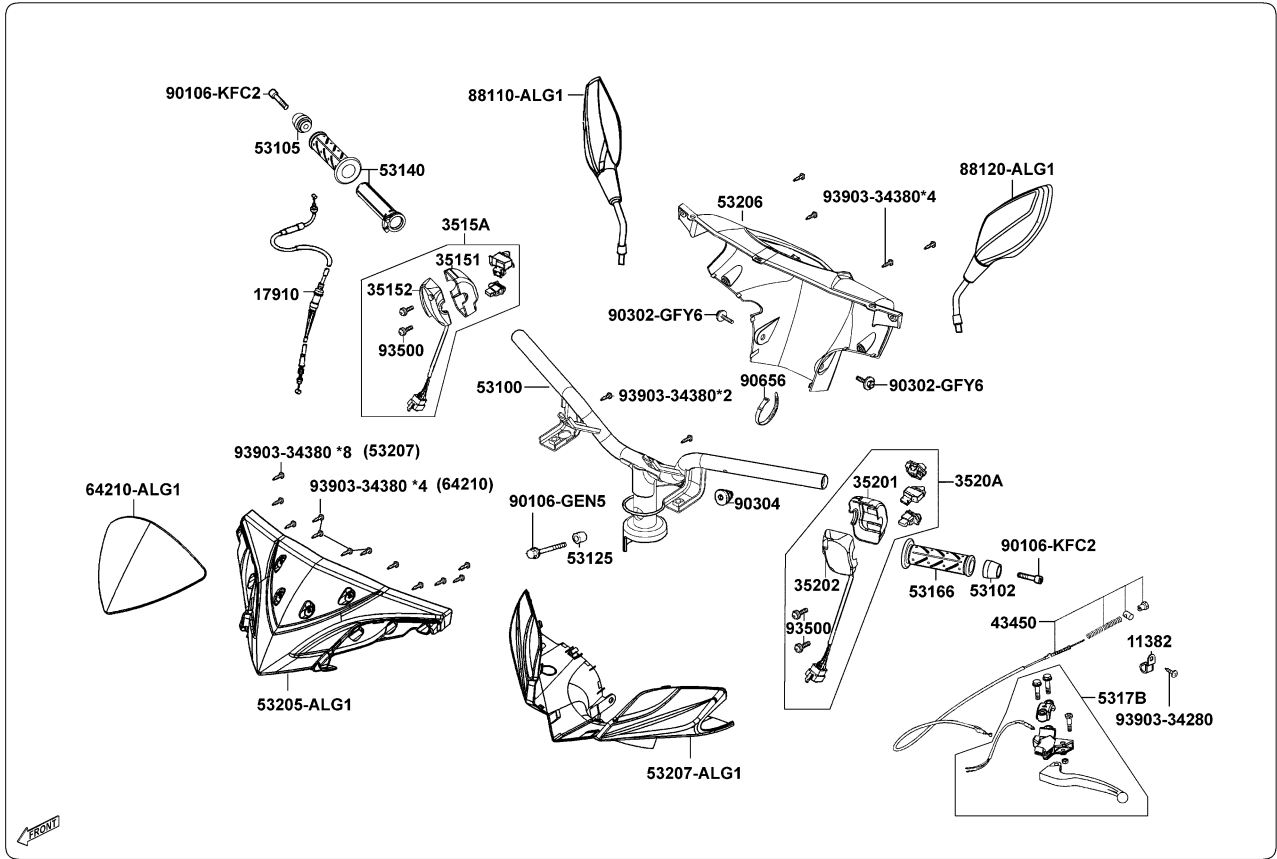

KP10BA(IT) F06

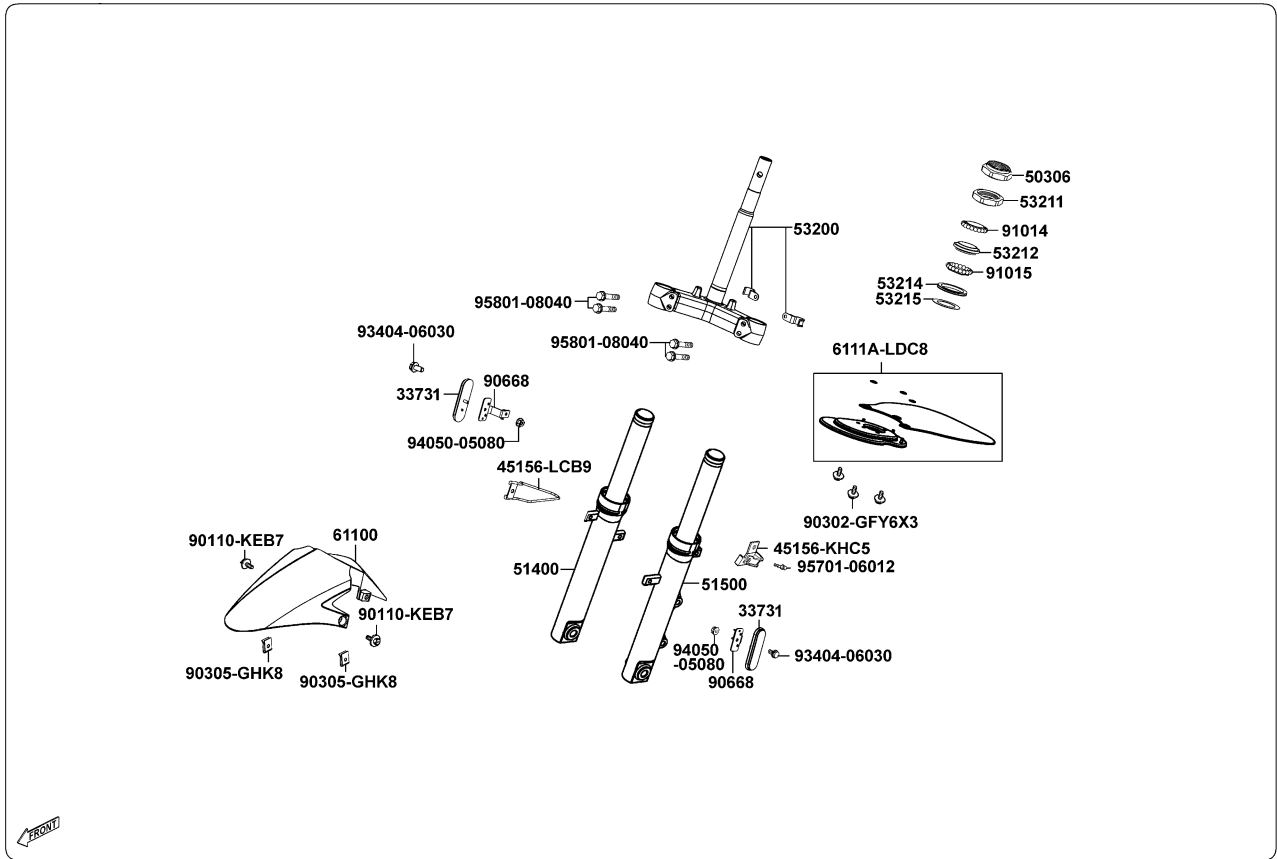



## 2. FRAME COVERS/EXHAUST MUFFLER

**NEW SUPER8 50**

SERVICE INFORMATION .....	2-1	EXHAUST MUFFLER REMOVAL .....	2-5
FRAME COVERS .....	2-2		

### SERVICE INFORMATION

#### GENERAL INSTRUCTIONS

- When removing frame covers, use special care not to pull them by force because the cover joint claws may be damaged.

#### Items Related for Removal

- Handlebar front cover ——— Handlebar rear cover  
Headlight wire connector
- Handlebar rear cover ——— Speedometer cable and instrument light  
wire connectors, etc.
- Frame body cover ——— Met-in box, rear grip, rear turn signal  
lights, floor board
- Floor board ——— Frame body cover  
Battery and wire connectors
- Leg Shield ——— Front cover, floor board

#### TORQUE VALUES

- |                                |              |
|--------------------------------|--------------|
| Exhaust muffler joint lock nut | 1.0~1.4kgf-m |
| Exhaust muffler lock bolt      | 3.0~3.6kgf-m |

## 2. FRAME COVERS/EXHAUST MUFFLER

NEW SUPER8 50

### FRAME COVERS

#### FRONT COVER REMOVAL

Remove the screw on the front cover.  
 Remove the two screws on the back of the front cover.  
 Remove the front cover.  
 Remove the two bolt and ten screws attaching the R/L mole side.  
 Remove the R/L mole side  
 The installation sequence is the reverse of removal.

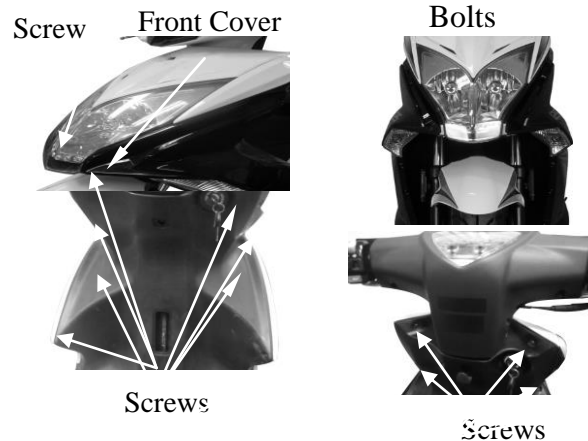

#### HANDLEBAR REAR COVER REMOVAL

Remove the handlebar rear cover screw.  
 Disconnect the speedometer cable, right and left handlebar switch couplers, and the stop switch wire connectors.  
 Remove two screws inside the handlebar rear cover and remove the handlebar rear cover.  
 The installation sequence is the reverse of removal.

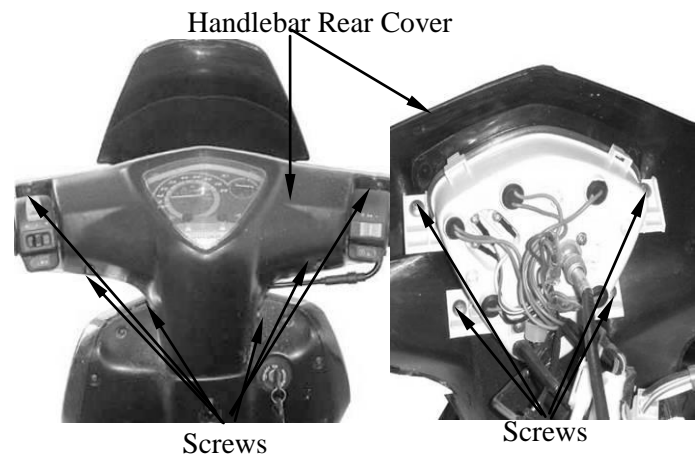

#### HANDLEBAR FRONT COVER REMOVAL

Remove the bolt attaching the handlebar front cover.  
 Remove the handlebar front cover.

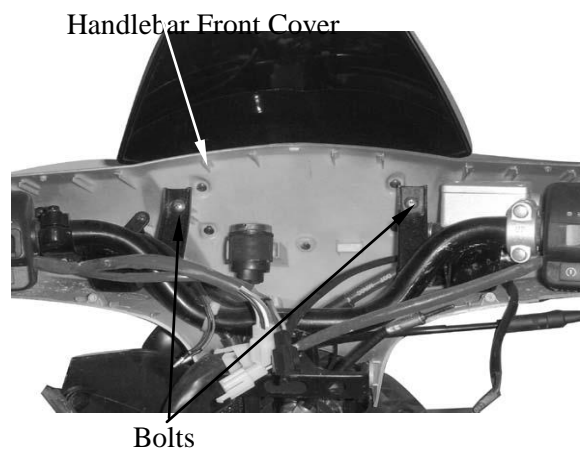

#### MET-IN BOX REMOVAL

Open the seat and remove the four bolt attaching the met-in box.  
 Remove the met-in box .

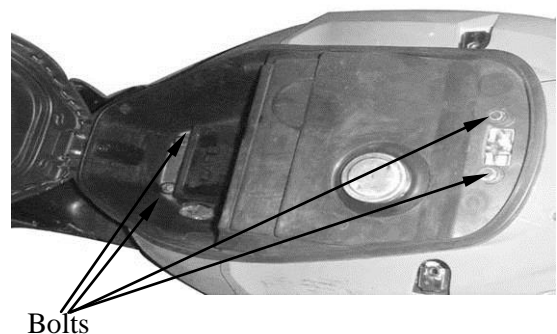

## 2. FRAME COVERS/EXHAUST MUFFLER

NEW SUPER8 50

### FRAME BODY COVER REMOVAL

Remove the two screws on the battery cover.  
Remove the center cover

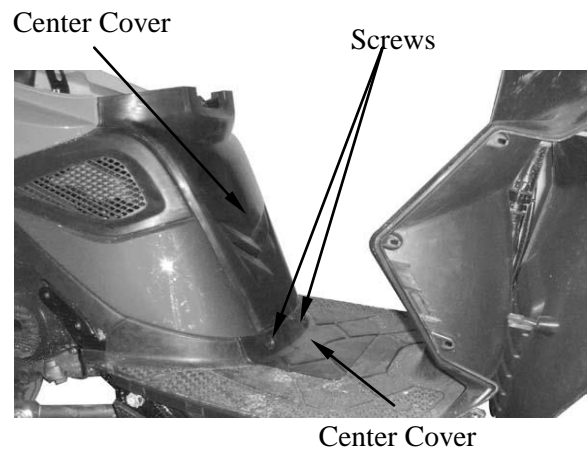

Remove the three bolts attaching the rear carrier.  
Remove the rear carrier.

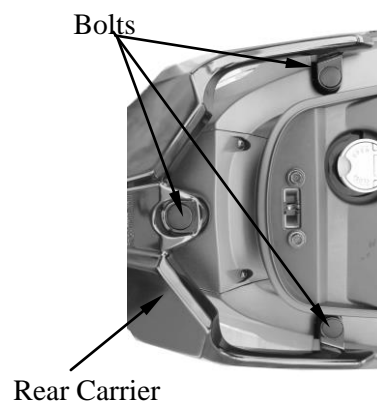

Remove the two bolt attaching the left and right rear step.  
Remove the rear step

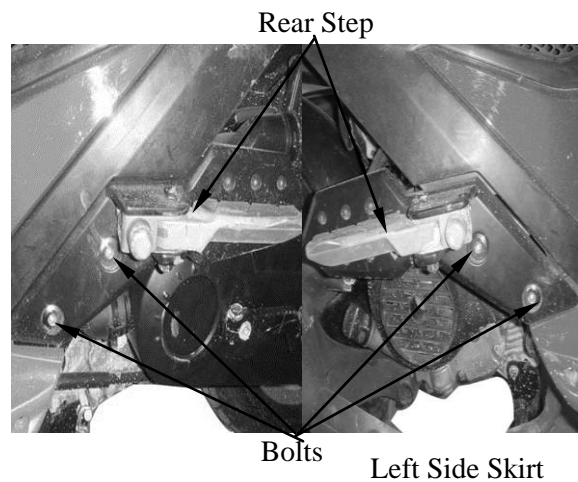

Remove the two screws attaching the left side and right side skirt  
Remove the left side and right side skirt

\* During removal, do not pull the joint claws forcibly to avoid damage.  
When installing, be sure to connect the seat lock wire.

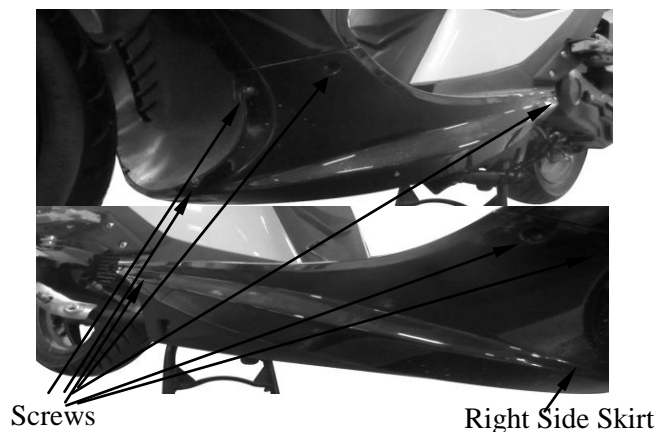

## 2. FRAME COVERS/EXHAUST MUFFLER

NEW SUPER8 50

Remove the two screws on the center rear cover.  
Remove the center rear cover.

Center Rear Cover.

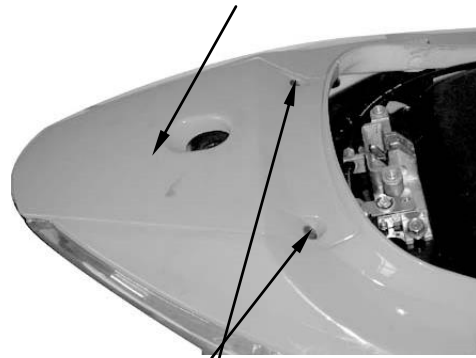

Remove the two bolts attaching the frame  
body cover.

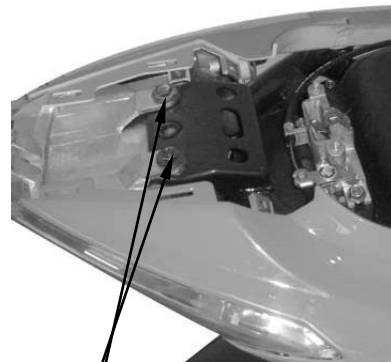

Bolts

Remove the two bolts attaching the rear  
fender.  
Disconnect the taillight wire connector  
Remove the rear fender.

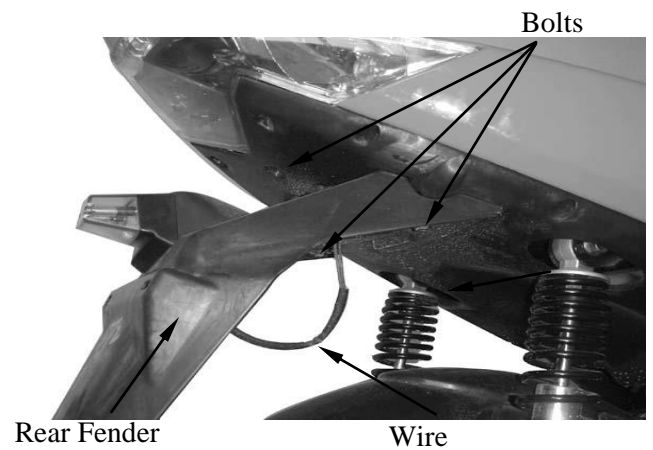

Bolts

Rear Fender

Wire

Remove the six screws attaching the fender  
rear inner.

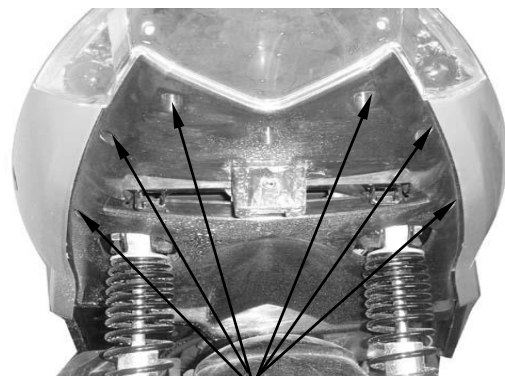

Screws

## 2. FRAME COVERS/EXHAUST MUFFLER

**NEW SUPER8 50**

Discorconnect the seat lock wire.  
 Discorconnect the tail lamp wire connectors  
 Remove the left and right body cover  
 The installation sequence is the reverse of remove

**\*** During removal, do not pull the joint claws forcedly to avoid damage.  
 When installing, be sure to connect the seat lock wire.

Seat Lock Wire



### FLOOR BOARD REMOVAL

Remove the rear carrier. (⇒2-3)  
 Remove the met-in box. (⇒2-3)  
 Remove the frame body cover. (⇒2-4)  
 Remove the four bolts attaching the floor board.  
 Remove the floor board.

Bolts

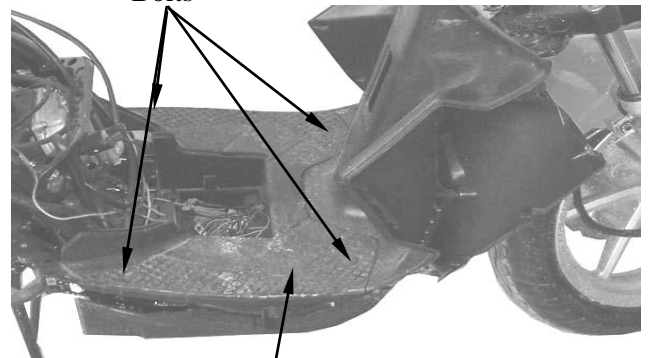

Floor Board.

### FRONT FENDER AND UNDER COWL REMOVAL

Remove the two on the under cowl.  
 Remove the under cowl.  
 Remove the L/R side bolts attaching the front fender and front fender.

Under Cowl

Screws

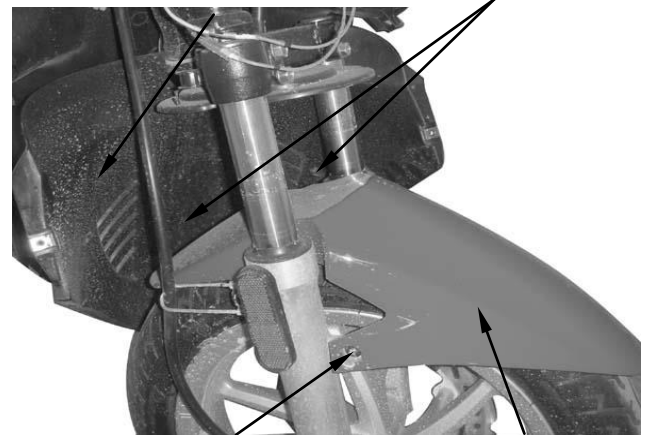

Bolt

Front Fender

### LEG SHIELD REMOVAL

Remove the two clip body on the lid leg shield  
 Remove the lid leg shield.  
 The installation sequence is the reverse of remove

Clip Body.

Lid Leg Shield.

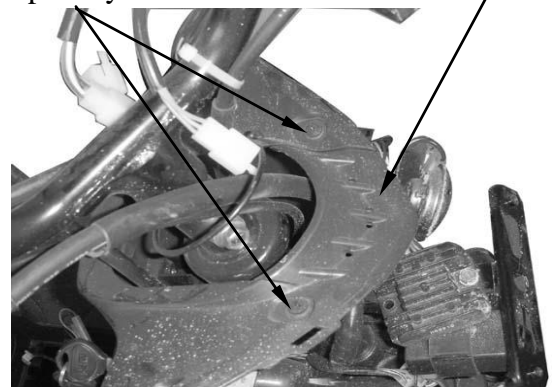



## 2. FRAME COVERS/EXHAUST MUFFLER

NEW SUPER8 50

Remove the decorative ring.  
Remove the leg shield.  
The installation sequence is the reverse of remove

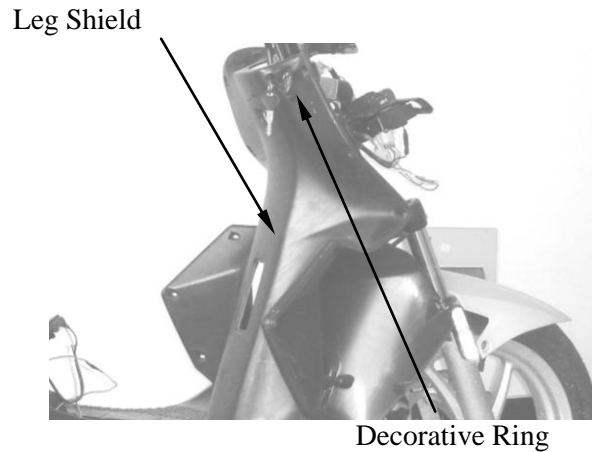

### EXHAUST MUFFLER REMOVAL

Disconnect the O<sub>2</sub> Sensor connector.  
Remove the two exhaust muffler joint lock nuts.  
Remove the two exhaust muffler lock bolts.  
Remove the exhaust muffler.  
Remove the exhaust muffler joint packing collar.



Bolts

When installing, first install the exhaust muffler packing collar and then install the exhaust muffler.  
First install and tighten the exhaust muffler joint lock nuts. Then, install and tighten the exhaust muffler lock bolts.  
Connect the O<sub>2</sub> Sensor connector.

#### Torques:

Exhaust muffler lock bolt: 3.0~3.6kgf-m  
Exhaust muffler joint lock nut: 1.0~1.4kgf-m

\* Be sure to install a new exhaust muffler packing collar.

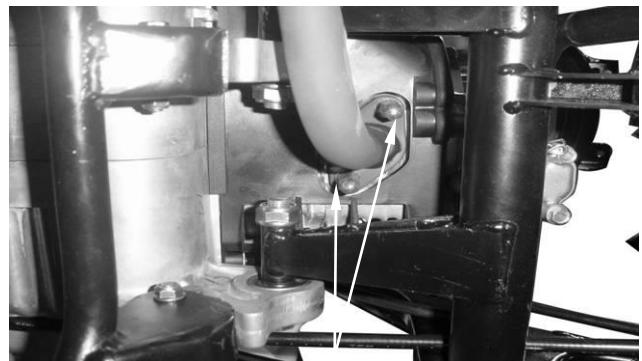

Lock Nut

<b>SERVICE INFORMATION.....3-0</b>	<b>FINAL REDUCTION GEAR OIL.....3- 7</b>
<b>MAINTENANCE SCHEDULE .....3-2</b>	<b>DRIVE BELT.....3- 7</b>
<b>FUEL FILTER.....3-3</b>	<b>HEADLIGHT AIM .....3- 8</b>
<b>THROTTLE OPERATION .....3-3</b>	<b>NUTS/BOLTS/FASTENERS .....3- 9</b>
<b>AIR CLEANER .....3-4</b>	<b>WHEELS/TIRES.....3- 9</b>
<b>SPARK PLUG.....3-4</b>	<b>STEERING HANDLEBAR.....3- 9</b>
<b>VALVE CLEARANCE.....3-5</b>	
<b>CARBURETOR IDLE SPEED .....3-5</b>	
<b>IGNITION TIMING .....3-6</b>	
<b>CYLINDER COMPRESSION .....3-6</b>	

### SERVICE INFORMATION

#### GENERAL

 **WARNING**

- Before running the engine, make sure that the working area is well-ventilated. Never run the engine in a closed area. The exhaust contains poisonous carbon monoxide gas which may cause death to people.
- Gasoline is extremely flammable and is explosive under some conditions. The working area must be well-ventilated and do not smoke or allow flames or sparks near the working area or fuel storage area.

#### SPECIFICATIONS

##### ENGINE

Throttle grip free play : 2~6mm  
 Spark plug gap : 0.6~0.7mm  
 Spark plug : NGK CR7HSA

Valve clearance : IN: 0.04mm  
 : EX: 0.04mm

Idle speed : 2000rpm

##### Engine oil capacity:

At disassembly : 0.85 liter

At change : 0.7 liter

##### Gear oil capacity :

At disassembly : 0.21 liter

At change : 0.18 liter



### 3. INSPECTION/ADJUSTMENT

---

Cylinder compression : 15kg/cm<sup>2</sup>

Ignition timing: 13° ~ 28°

#### CHASSIS

Front brake free play: 10~20mm

Rear brake free play : 10~20mm

#### TIRE PRESSURE

	1 Rider	2 Riders
Front	1.5kg/cm <sup>2</sup>	2.0kg/cm <sup>2</sup>
Rear	1.75kg/cm <sup>2</sup>	2.25kg/cm <sup>2</sup>

#### TIRE SIZE:

Front : 120/70-14

Rear : 120/80-14

#### TORQUE VALUES

Front axle nut 5.0~7.0kgf-m

Rear axle nut 11~13kgf-m

### 3. INSPECTION/ADJUSTMENT

#### MAINTENANCE SCHEDULE

Perform the periodic maintenance at each scheduled maintenance period.

I: Inspect, and Clean, Adjust, Lubricate or Replace if necessary.

A: Adjust C: Clean R: Replace T : Tighten

Item	Frequency	Whichever comes first ⇔ ↓	Regular Service Mileage (km)										
			1000	2000	3000	4000	5000	6000	7000	8000	9000	10000	11000
Engine oil		R New Motorcycle 300km	R		R		R		R		R		R
Engine oil filter screen					C				C				
Fuel filter screen											R		
Gear oil	Note 3	R New motorcycle 300km				R					R		
Valve clearance			A		A				A				A
Air Cleaner	Note 2,3	Replace at every 2000km											
Spark plug		Clean at every 3000km and replace if necessary											
Brake system			I	I	I	I	I	I	I	I	I	I	I
Drive belt									I				
Suspension					I				I				I
Nut, bolt, fastener									I				
Tire					I				I				I
Steering head bearing			I					I					I

- In the interest of safety, we recommend these items should be serviced only by an authorized KYMCO motorcycle dealer.

Note: 1. For higher odometer readings, repeat at the frequency interval established here.  
 2. Service more frequently when riding in dusty or rainy areas.  
 3. Service more frequently when riding in rain or at full throttle.

### 3. INSPECTION/ADJUSTMENT

#### THROTTLE OPERATION

Check the throttle grip for smooth movement.  
Measure the throttle grip free play.

**Free Play:** 2~6mm

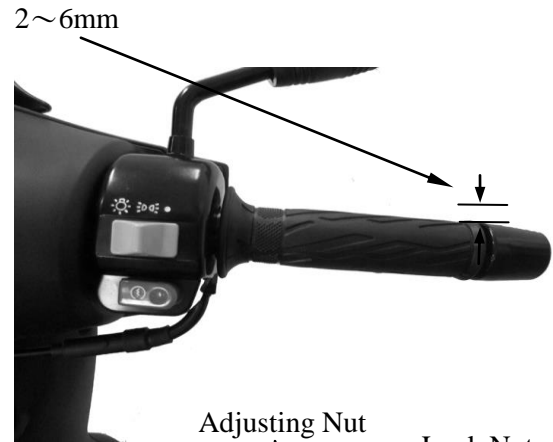

Major adjustment of the throttle grip free play is made at the carburetor side.  
Adjust by loosening the lock nut and turning the adjusting nut.

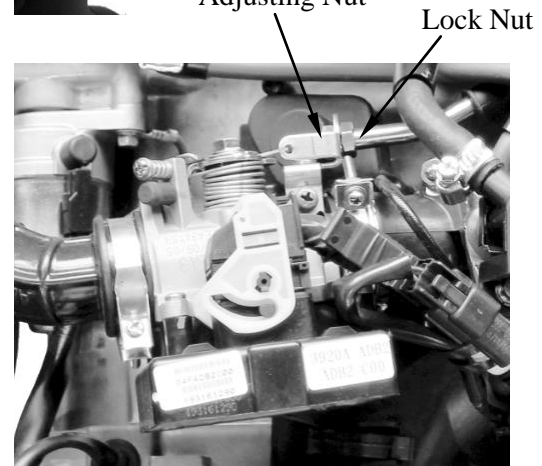

Minor adjustment is made with the adjusting nut at the throttle grip side.  
Slide the rubber cover out and adjust by loosening the lock nut and turning the adjusting nut.

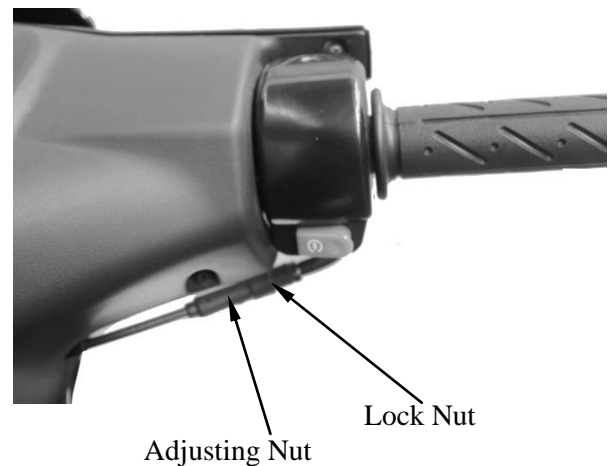

### 3. INSPECTION/ADJUSTMENT

#### AIR CLEANER

##### AIR CLEANER REPLACEMENT

Remove the air cleaner case cover by removing the 7 screws.

Remove the air cleaner element by removing the four screws.

Check the element and replace it if it is excessively dirty or damaged.

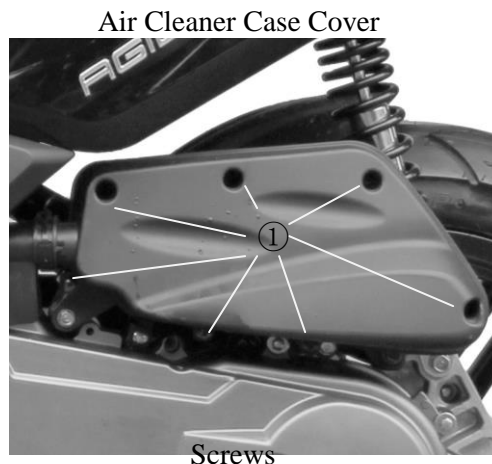

Screws

Air Cleaner Element

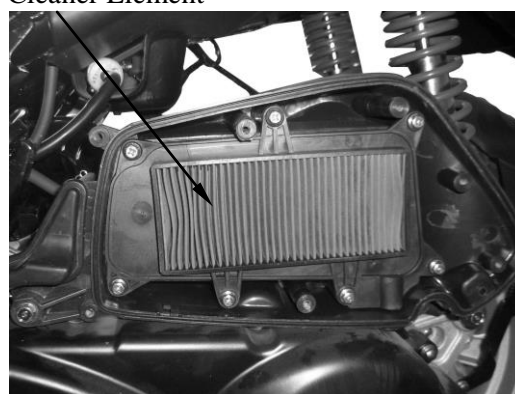

#### CHANGE INTERVAL

More frequent replacement is required when riding in unusually dusty or rainy areas.

- \* The air cleaner element has a viscous type paper element. Do not clean it with any fluid.
- Be sure to install the air cleaner element and cover securely.

#### SPARK PLUG

Remove the spark plug.

Check the spark plug for wear and fouling deposits.

Clean any fouling deposits with a spark plug cleaner or a wire brush.

##### Specified Spark Plug:

NGK CR7HSA

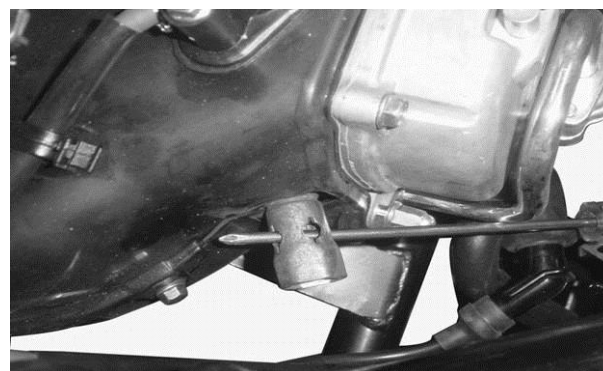

Measure the spark plug gap.

**Spark Plug Gap:** 0.6~0.7mm

- \* When installing, first screw in the spark plug by hand and then tighten it with a spark plug wrench.

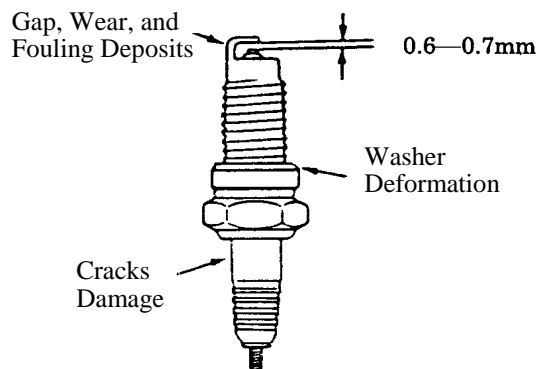

### 3. INSPECTION/ADJUSTMENT

#### VALVE CLEARANCE

\* Inspect and adjust valve clearance while the engine is cold (below 35°C).

- Remove the frame cover. (⇒2-3)
- Remove the six bolts on the cylinder head cover.
- Remove the cylinder head cover. (⇒7-3)
- Remove the cylinder head cover..

Cylinder Head Cover



Bolts

Turn the flywheel counterclockwise so that the “T” mark on the flywheel aligns with the index mark on the crankcase to bring the round hole on the camshaft gear facing up to the top dead center on the compression stroke.

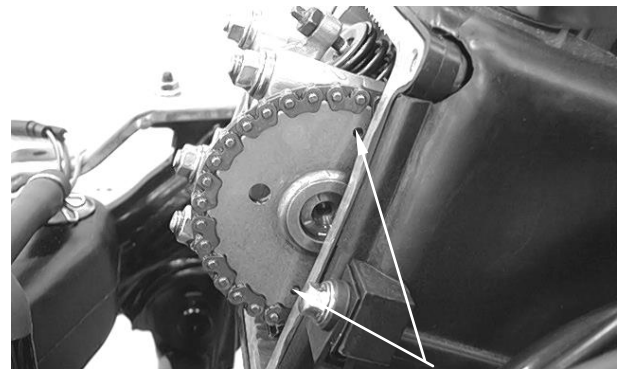

Round Hole

Inspect and adjust the valve clearance.

**Valve Clearance:** IN : 0.1mm  
EX: 0.1mm

Loosen the lock nut and adjust by turning the adjusting nut

Special

Tappet Adjuster

\* • Check the valve clearance again after the lock nut is tightened.

Tappet Adjuster

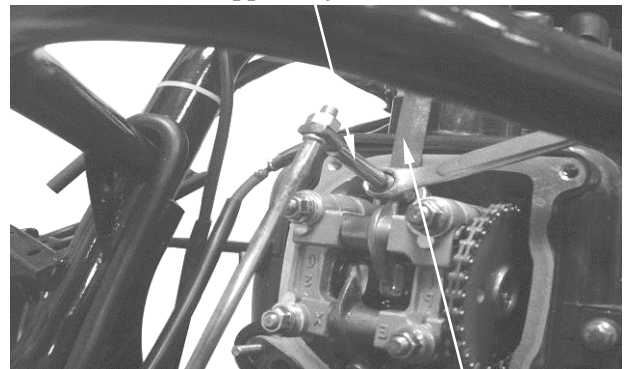

Feeler Gauge

### 3. INSPECTION/ADJUSTMENT

Super 8 50

#### IGNITION TIMING

\* The CDI unit is not adjustable. If the ignition timing is incorrect, check the ignition system. (⇒ 15-5)

Remove the right of the fan cover.

Timing Hole Cap



Check the ignition timing with a timing light. When the engine is running at idle speed, the ignition timing is correct if the "F" mark on the flywheel aligns with the index mark on the crankcase.

Timing Light



Also use a timing light to check the advance. Raise the engine speed to 4,000rpm and the index mark on the crankcase cover should be aligned with the advance mark on the flywheel.

#### CYLINDER COMPRESSION

Warm up the engine before compression test. Remove the met-in box and center cover. (⇒ 2-3)

Remove the spark plug.

Insert a compression gauge.

Open the throttle valve fully and push the starter button to test the compression.

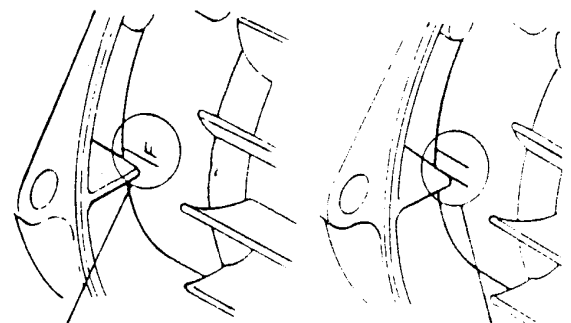

"F" Mark

Advance Mark

**Compression:** 13kg/cm<sup>2</sup>rpm

If the compression is low, check for the following:

- Leaky valves
- Valve clearance too small
- Leaking cylinder head gasket
- Worn piston rings
- Worn piston/cylinder

If the compression is high, it indicates that carbon deposits have accumulated on the combustion chamber and the piston head.

Compression Gauge

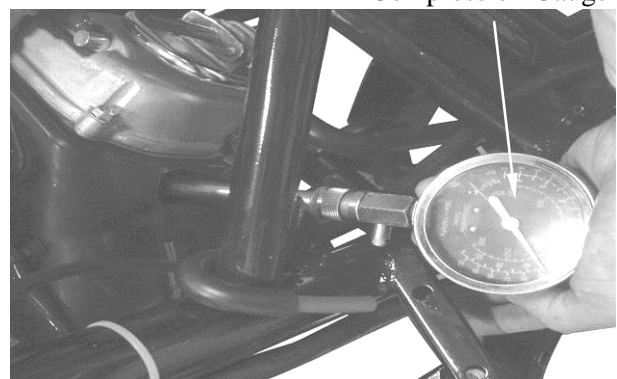



### 3. INSPECTION/ADJUSTMENT

#### FINAL REDUCTION GEAR OIL OIL LEVEL CHECK

- \* Place the motorcycle on its main stand on level ground for oil level check.

Stop the engine and remove the oil check bolt. The oil level shall be at the oil check bolt hole.

If the oil level is low, add the recommended oil to the proper level.

**Recommended Oil: SAE90#**

Install the oil check bolt.

- \* Make sure that the sealing washer is in good condition.

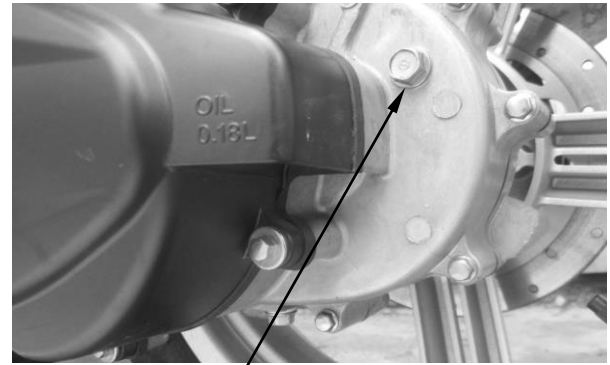

Oil Check Bolt/Sealing Washer

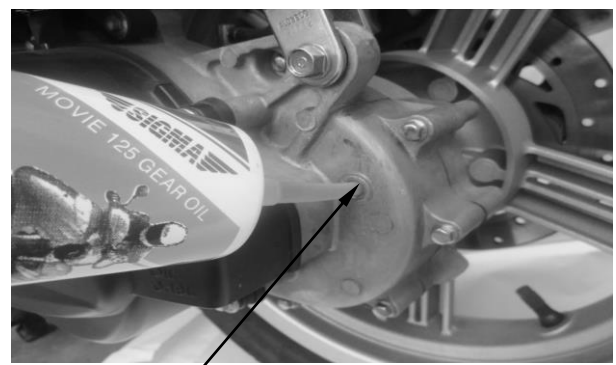

Oil Check Bolt Hole

#### OIL CHANGE

Remove the oil check bolt.

Remove the oil drain bolt and drain the oil thoroughly.

Install the oil drain bolt.

**Torque: 0.8~1.2kgf-m**

- \* Make sure that the sealing washer is in good condition.

Fill with the recommended oil.

**Oil Capacity:** At disassembly : 0.21liter  
At change : 0.18 liter

Reinstall the oil check bolt and check for oil leaks.

**Torque:0.8~1.2kgf-m**



Oil Drain Bolt/ Sealing Washer

#### DRIVE BELT

Remove the left crankcase cover. (⇒9-2)

Inspect the drive belt for cracks or excessive wear.

Replace the drive belt with a new one if necessary and in accordance with the Maintenance Schedule.

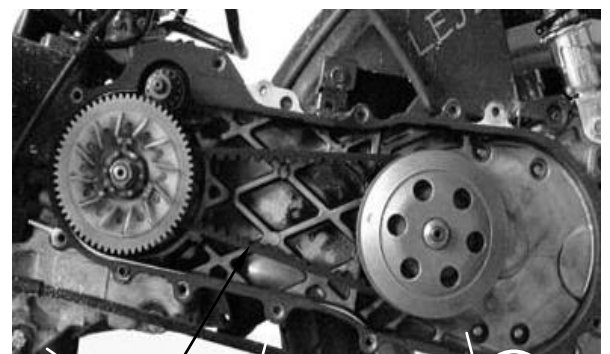

Drive Belt

### 3. INSPECTION/ADJUSTMENT

#### HEADLIGHT AIM

Turn the ignition switch ON and start the engine.  
Turn on the headlight switch.  
Adjust the headlight aim by turning the headlight aim adjusting screw.

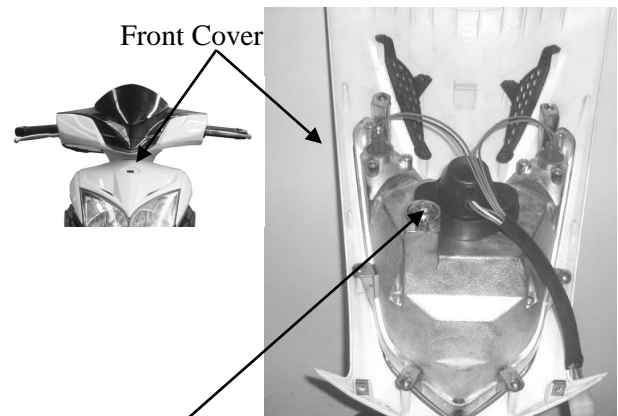

#### CLUTCH SHOE WEAR

Start the engine and check the clutch operation by increasing the engine speed gradually.  
If the motorcycle tends to creep, or the engine stalls, check the clutch shoes for wear and replace if necessary. (⇒9-11)

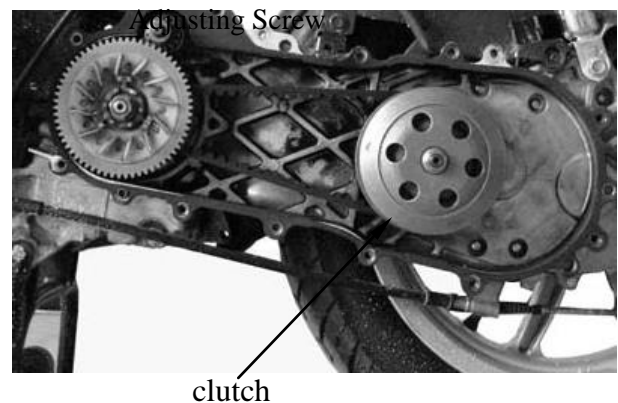

#### SUSPENSION

##### FRONT

Fully apply the front brake lever and check the action of the front shock absorbers by compressing them several times.  
Check the entire shock absorber assembly for oil leaks, looseness or damage.



##### REAR

Check the action of the rear shock absorber by compressing it several times.  
Check the entire shock absorber assembly for oil leaks, looseness or damage.  
Jack the rear wheel off the ground and move the rear wheel sideways with force to see if the engine hanger bushings are worn.



### 3. INSPECTION/ADJUSTMENT

#### NUTS/BOLTS/FASTENERS

Check all important chassis nuts and bolts for looseness.

Tighten them to their specified torque values if any looseness is found. (⇒1-11)

#### WHEELS/TIRES

Check the tires for cuts, imbedded nails or other damages.

Check the tire pressure.

\* Tire pressure should be checked when tires are cold.

#### TIRE PRESSURE

	1 Rider	2 Riders
Front	1.5kg/cm <sup>2</sup>	1.75kg/cm <sup>2</sup>
Rear	2.00kg/cm <sup>2</sup>	2.25kg/cm <sup>2</sup>

#### TIRE SIZE

**Front** : 120/70-14

**Rear** : 120/80-14

Check the front axle nut for looseness.

Check the rear axle nut for looseness.

If the axle nuts are loose, tighten them to the specified torques.

**Torques: Front** : 5.0~7.0kgf-m

**Rear** : 11~13kgf-m



Front Axle

#### STEERING HANDLEBAR

Check that the control cables do not interfere with handlebar rotation.

Raise the front wheel off the ground and check that the steering handlebar rotates freely.

If the handlebar moves unevenly, binds, or has vertical movement, adjust the steering head bearing.



## 4. LUBRICATION SYSTEM

---

# 4

---

---

---

---

---

---

---

---

---

---

# 4

## LUBRICATION SYSTEM

---

SERVICE INFORMATION-----	4- 1
TROUBLESHOOTING-----	4- 1
ENGINE OIL/OIL FILTER -----	4- 2
OIL PUMP-----	4- 2

## 4. LUBRICATION SYSTEM

---

### SERVICE INFORMATION

#### GENERAL INSTRUCTIONS

- The maintenance of lubrication system can be performed with the engine installed in the frame.
- Use care when removing and installing the oil pump not to allow dust and foreign matters to enter the engine and oil line.
- Do not attempt to disassemble the oil pump. The oil pump must be replaced as a set when it reaches its service limit.
- After the oil pump is installed, check each part for oil leaks.

#### SPECIFICATIONS

Item		Standard (mm)	Service Limit (mm)
Oil pump	Inner rotor-to-outer rotor clearance	—	0.12
	Outer rotor-to-pump body clearance	—	0.12
	Rotor end-to-pump body clearance	0.05~0.10	0.2

#### TROUBLESHOOTING

##### Oil level too low

- Natural oil consumption
- Oil leaks
- Worn or poorly installed piston rings
- Worn valve guide or seal

##### Poor lubrication pressure

- Oil level too low
- Clogged oil filter or oil passages
- Not use the specified oil

# 4. LUBRICATION SYSTEM

## ENGINE OIL/OIL FILTER

### OIL LEVEL

- \* Place the motorcycle upright on level ground for engine oil level check.
- \* Run the engine for 2~3 minutes and check the oil level after the engine is stopped for 2~3 minutes.

Remove the oil dipstick and check the oil level with the oil dipstick.  
If the level is near the lower level, fill to the upper level with the specified engine oil.

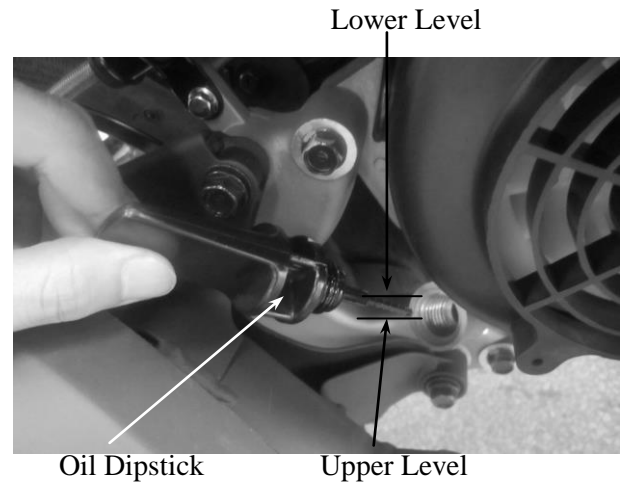

### OIL CHANGE

- \* The engine oil will drain more easily while the engine is warm.

Remove the oil filter screen cap located on the bottom of the engine to drain the engine oil thoroughly.



After the oil has been completely drained, check the filter screen O-ring for damage and replace if necessary.  
Install the oil filter screen, spring and filter screen cap.

**Torque:** 1.5kg-m

Fill with the specified SAE15W40#, API: SG engine oil to the proper level.

Oil Capacity: At disassembly : 0.90 liter

At change : 0.80 liter

Check for oil leaks and then start the engine and let it idle for few minutes.

Recheck the oil level.



O-ring

### OIL PUMP

#### REMOVAL

Remove the A.C. generator flywheel.  
Remove the nine right crankcase cover bolts and the right crankcase cover.

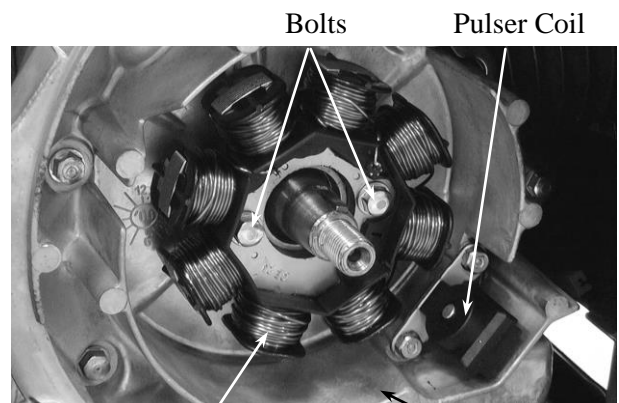

Bolts Pulser Coil  
Stator Right Crankcase Cover

## 4. LUBRICATION SYSTEM

Remove the gasket and dowel pins.  
Remove the starter idle gear and starter clutch.



Gasket

Remove the two bolts and oil separator cover.

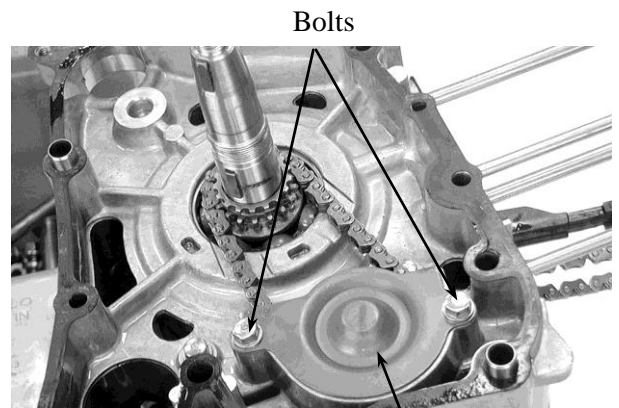

Bolts

Oil Separator Cover

Remove the oil pump driven gear nut to  
remove the oil pump driven gear and drive  
chain.

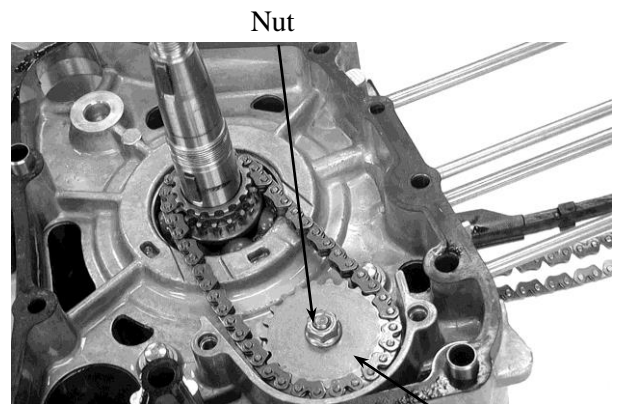

Nut

Oil Pump Driven Gear

Remove the two oil pump mounting bolts  
and the oil pump.

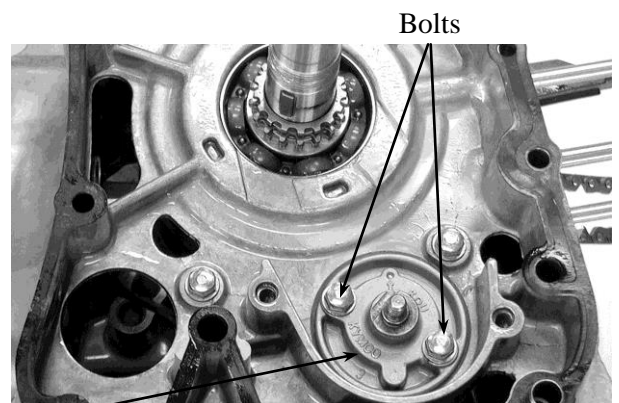

Bolts

Oil Pump

## 4. LUBRICATION SYSTEM

### DISASSEMBLY

Remove the screw and disassemble the oil pump.

Screw

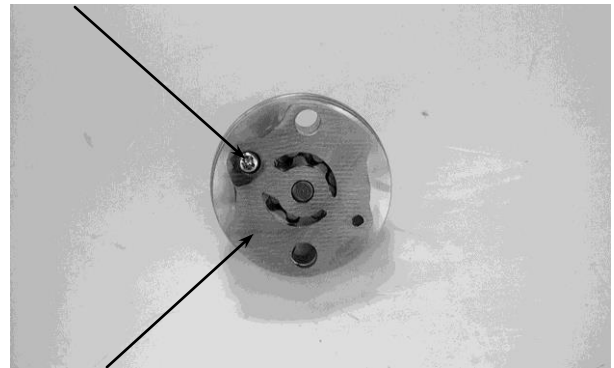

Pump Body

### INSPECTION

Measure the pump body-to-outer rotor clearance.

**Service Limit:** 0.12mm

Outer Rotor

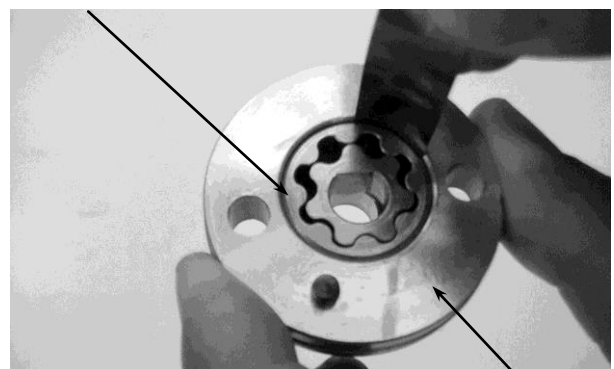

Pump Body

Measure the inner rotor-to-outer rotor clearance.

**Service Limit:** 0.12mm

Outer Rotor

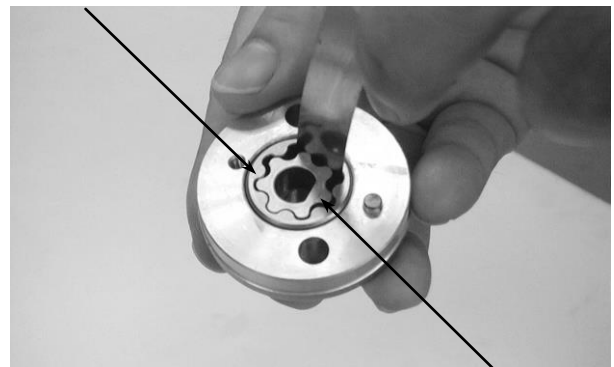

Inner Rotor

Measure the rotor end-to-pump body clearance.

**Service Limit:** 0.2mm

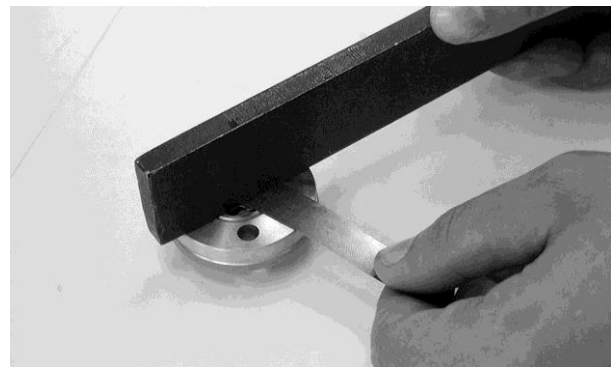



## 4. LUBRICATION SYSTEM

### ASSEMBLY

Install the outer rotor, inner rotor and pump shaft into the pump body.

- \* Insert the pump shaft by aligning the flat on the shaft with the flat in the inner rotor.

Install the dowel pin.  
Install the pump cover by aligning the hole in the cover with the dowel pin.

Tighten the screw to secure the pump cover.  
Make sure that the pump shaft rotates freely without binding.

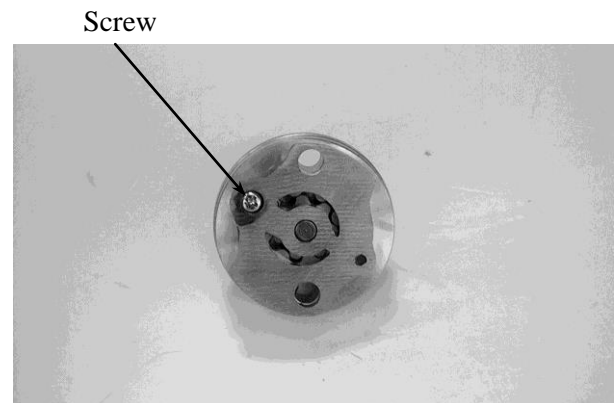
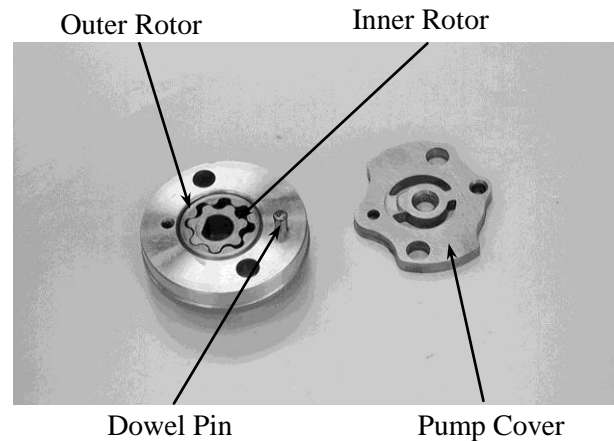

### INSTALLATION

Install the oil pump into the crankcase.

- \* Install the oil pump with the arrow on the pump body facing up and fill the oil pump with engine oil before installation.

After the oil pump is installed, tighten the two mounting bolts.

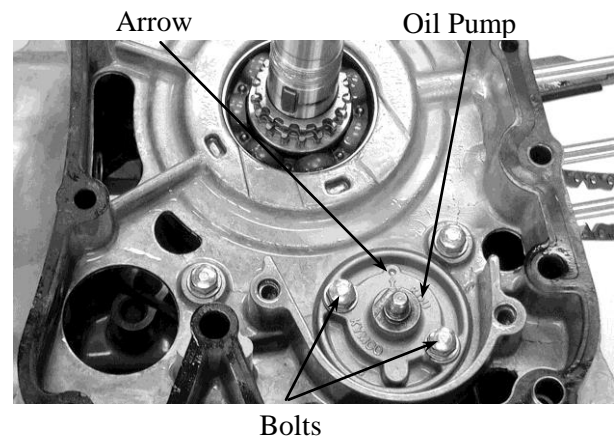

Install the pump driven gear and drive chain by aligning the pump driven gear with the cutout in the pump shaft.  
Install and tighten the pump driven gear nut.

**Torque:** 1.0kg-m

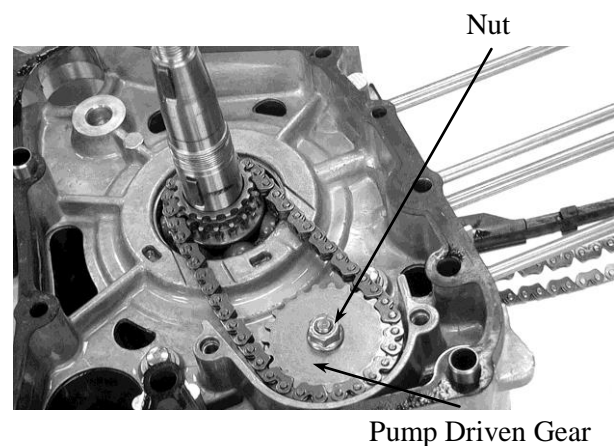

## 4. LUBRICATION SYSTEM

Install the oil separator cover and tighten the bolts.

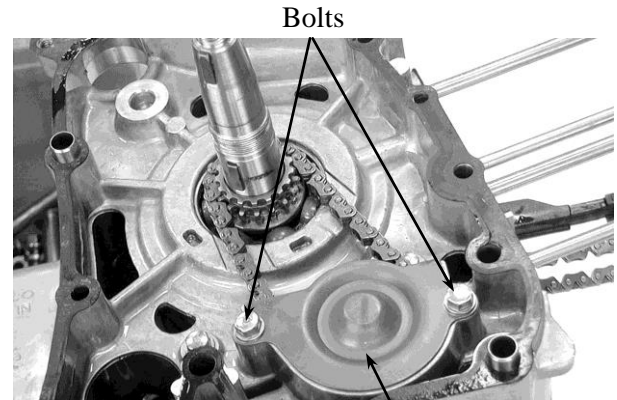

Oil Separator Cover

Install the starter idle gear and starter clutch. Install the gasket and dowel pins.

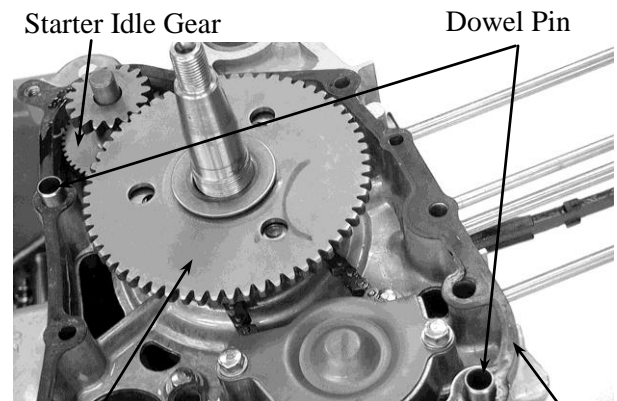

Starter Clutch

Gasket

Install the right crankcase cover and tighten the nine bolts.

**Torque:** 0.9kg-m

\* Diagonally tighten the bolts in 2~3 times.

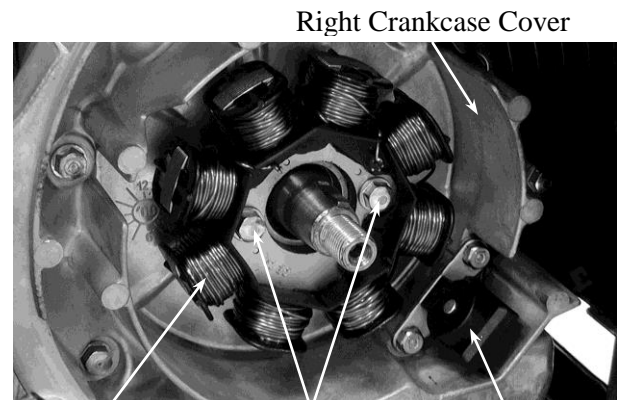

Stator

Bolts

Pulser Coil

**FUEL INJECTION SYSTEM**

SYSTEM DIAGRAM .....	5 - 1
SYSTEM LOCATION.....	5 - 2
SERVICE INFORMATION .....	5 - 3
TROUBLESHOOTING .....	5 - 4
CHECK ENGINE LAMP (CELP).....	5 - 5
HOW TO SHOW THE FAILURE CODE.....	5 - 6
FAILURE CODES CHART .....	5 - 7
ECU .....	5-11
FUEL PUMP .....	5-12
T-MAP & TPS.....	5-13
WTS.....	5-14
INJECTOR .....	5-14
O <sup>2</sup> SENSOR .....	5-15
ROLL SENSOR .....	5-16
TP SCREW.....	5-16
TPI / ABV INITIALIZATION .....	5-17
DIAGNOSTIC REPORT .....	5-18
Fi DIAGNOSTIC TOOL OPERATION INSTRUCTIONS.....	5-19



# 5. FUEL INJECTION SYSTEM

## SYSTEM DIAGRAM

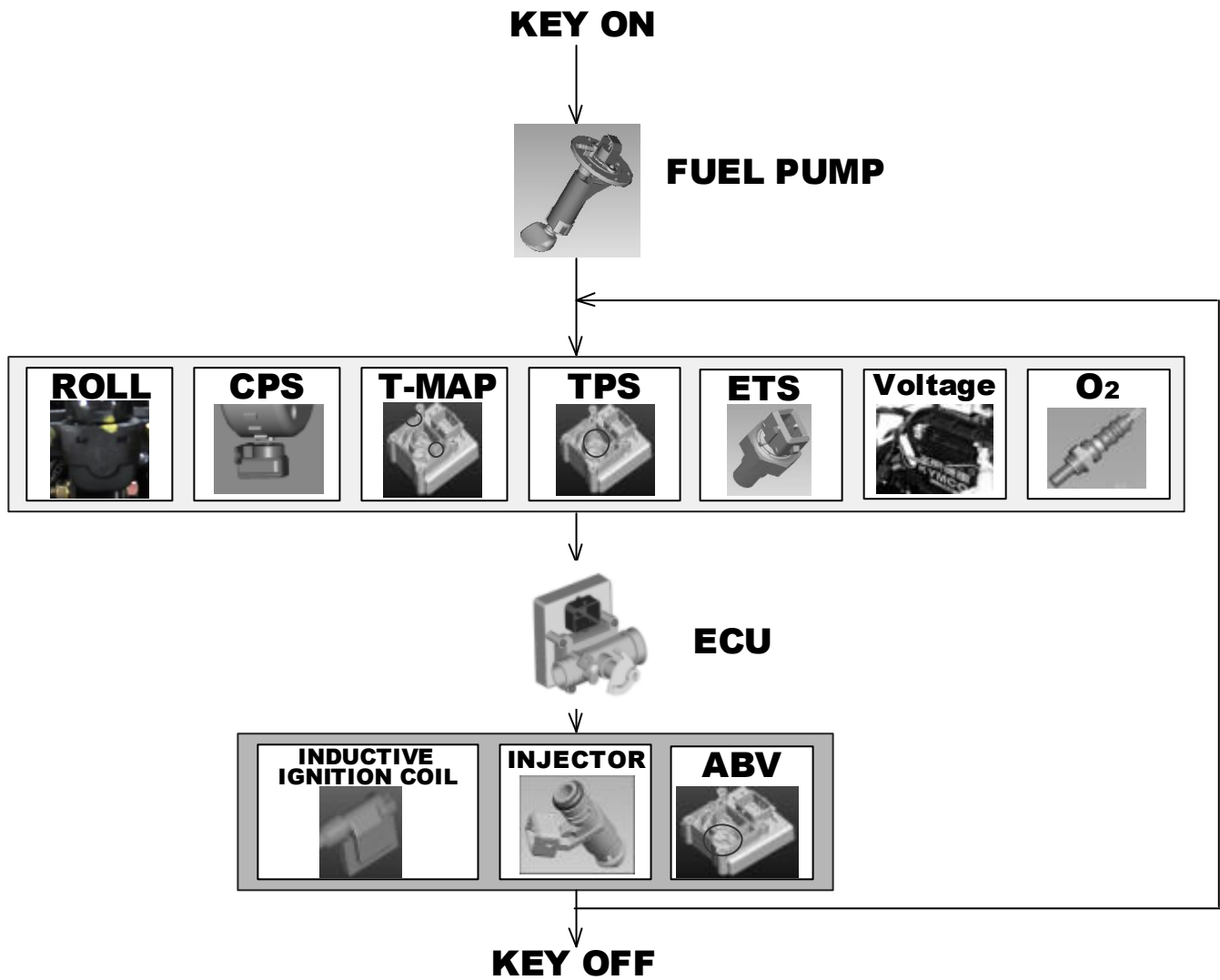

# 5. FUEL INJECTION SYSTEM

## Parts Location

- 01: Inductive ignition coil
- 02: Fuel pump
- 03: ECU
- 04: Fuel injector
- 05: ETS sensor
- 06: T-MAP sensor
- 07: ABV
- 08: TPS
- 09: Roll sensor
- 10: CPS
- 11: O2/O2 HT sensor

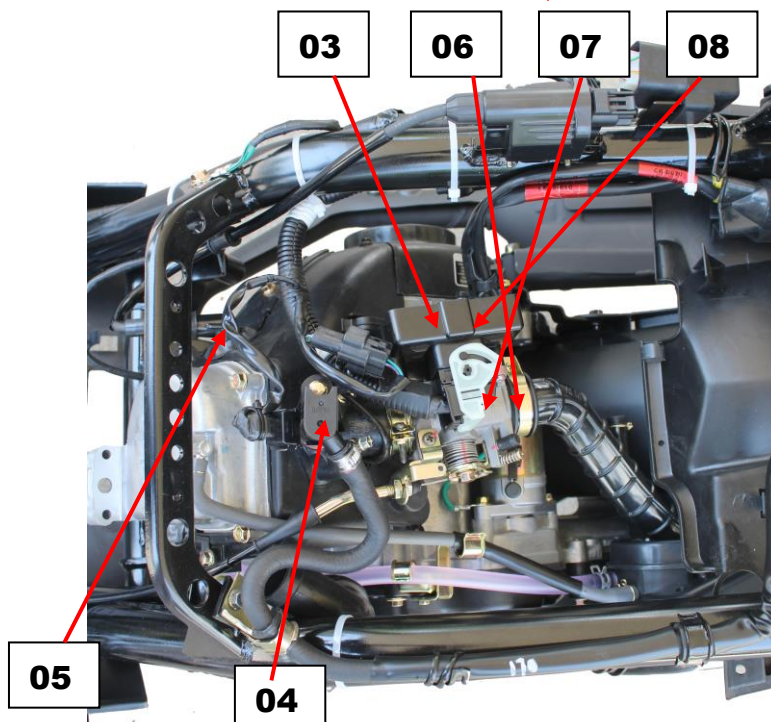
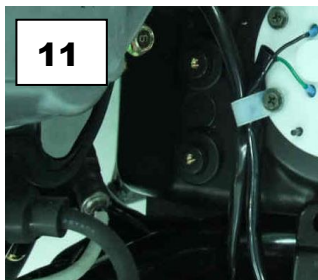
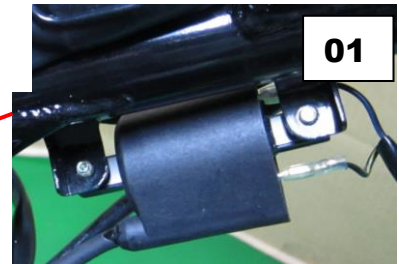
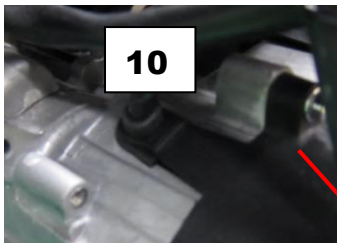
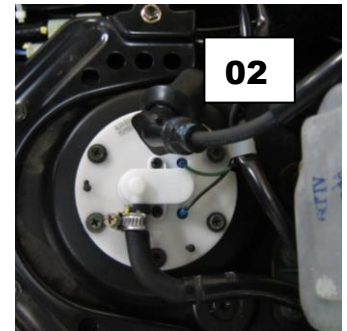

## 5. FUEL INJECTION SYSTEM

### SERVICE INFORMATION

#### GENERAL INSTRUCTIONS

\* Gasoline is very dangerous. When working with gasoline, keep sparks and flames away from the working area.  
Gasoline is extremely flammable and is explosive under certain conditions. Be sure to work in a well-ventilated area.

- Disconnect the cables of the battery when the engine is running, which could lead to ECU damage.
- Connect the harness positive (+) cable to the battery negative (-) terminal or connect the harness negative (-) to the battery positive (+) terminal, which could lead to ECU damage.
- Always keep fuel over 750 cc in fuel tank.

#### SPECIFICATIONS

Item		Standard	
Charging voltage of battery		13.5 ~ 14.5V	
Voltage from the ECU to sensor		5±0.1V	
Fuel injector resistance (20 °C/68 °F)		10.6 ~ 15.9Ω	
Water temperature sensor resistance		2.075±10 KΩ (20~30 °C)	
Throttle position sensor voltage		Idle (0 °) = 0.23±0.05V Throttle fully (90 °/3.27V over)	
Fuel pump resistance (20 °C/68 °F)		F: about 1100Ω E: about 100Ω	
O2 sensor	O2 sensor heater resistance	6.7 ~ 9.5Ω	
	Voltage	Air/Fuel<14.7 (Rich)	>0.7V
		Air/Fuel>14.7 (Lean)	<0.18V
Crank position sensor (Pulser) resistance		95 ~ 144Ω	
Inductive ignition coil resistance (20 °C/68 °F)		0.55 ~ 0.75Ω	
Roll sensor voltage (diagnostics)		Normal: 0.3 ~ 1.4V Fall down (>65 °): 3.5 ~ 4.7V	
Idle speed		1850±100 rpm	

## 5. FUEL INJECTION SYSTEM

---

### TROUBLESHOOTING

#### **Engine won't start**

- Battery voltage too low
- Fuel level too low
- Pinched or clogged fuel hose
- Faulty fuel pump operating system
- Clogged fuel filter (fuel pump)
- Clogged fuel injector
- Faulty spark plug or wrong type
- Cut by ECU due to angle detect sensor or incorrect function

#### **Backfiring or misfiring during acceleration**

- Ignition system malfunction

#### **Poor performance (drive ability) and poor fuel economy**

- Pinched or clogged fuel hose
- Faulty fuel injector

#### **Engine stall, hard to start, rough idling**

- Intake air leak
- Fuel contaminated/deteriorated
- Pinched or clogged fuel hose
- Idle speed misadjusted

## 5. FUEL INJECTION SYSTEM

### CHECK ENGINE LAMP (CELP)

- When turning on the switch, the lamp will be lighted for 2 seconds then off. Let user to know the lamp is available and connect to ECU.
- But after then or during riding, if the CELP start to blink or keep lighting, it means something wrong with this vehicle, you better do the further check to find out the failure code to know which part get trouble
- There are three kinds of priority grade let user to know what kind of trouble was happened.
- Priority grade 1: CELP blinks continuously. This is the most emergent situation like engine over heat. User should be slow down the riding and go to dealer for checking.
- Priority grade 2: CELP lights all the time. It means components gets trouble or circuit something wrong. Do the further check to find out the failure code to know which part get trouble.
- Priority grade 3: CELP just blinks once suddenly and then disappear. It sometimes just warning like the RPM was too high in a short term.

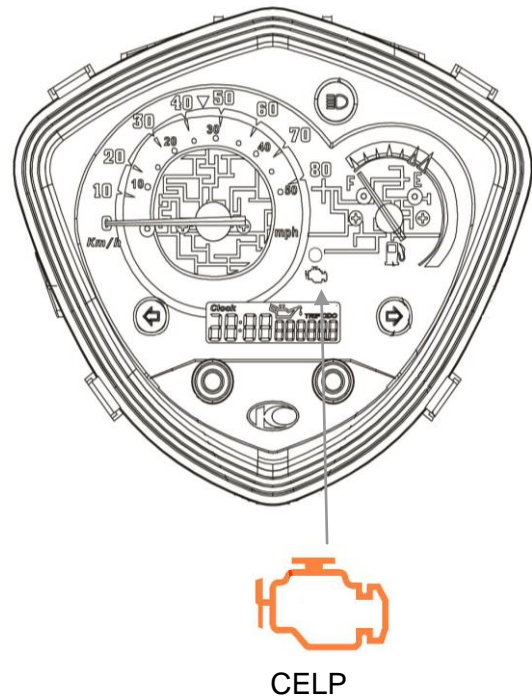

PRIORITY	LAMP ACTION
1	<p>ON OFF</p>
2	<p>ON OFF</p>
3	<p>ON OFF</p>



## 5. FUEL INJECTION SYSTEM

### How To Show Failure Code

- You can read the failure code by as below :
- Turn switch on. The CELP will be lighted for 2 seconds then off. The CELP start to blink to show the failure codes
- (The number of blinks from 1 to 25).
- If vehicle got more than one failure code, the CELP will be shown from lower number failure code and then show the other higher number one after four seconds. All the failure codes would be shown repeatedly.

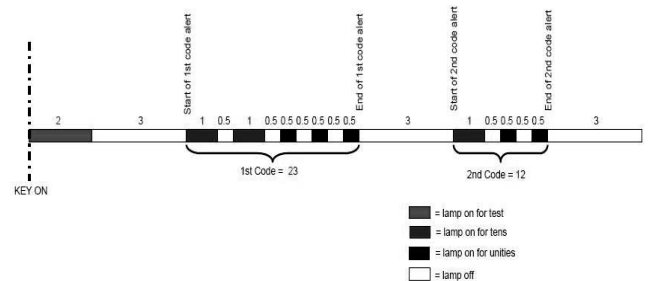

### How To Reset Failure Code

- After repairing the trouble, you should clear the failure code or it will still exist in the ECU memory. When you do a next maintain, it will show again and you get confuse.
- Turn switch on. The CELP will be lighted for two seconds then off.
- The CELP begins to blink to show the failure codes.
- The self-diagnosis memory data will be erased when all the failure codes has showed for four cycles.

## 5. FUEL INJECTION SYSTEM

---

### Failure Code Chart

Blink	Failure Codes	Fault description	Priority	Fault management
1	P0217	Engine temperature overheat	1	1.Slow down the vehicle and go to workshop for checking immediately. 2.Confirm if the engine temperature sensor or electric circuit is abnormality.
2	P0335	Crankshaft position sensor or circuit malfunction	2	1.Check if the connector of crankshaft position sensor is loosen. 2.Check if the Rotor is align with Crankshaft position sensor during the crankshaft running.
3	P1120	Throttle position sensor setting value problem	2	1.Make sure if the connector of Throttle position sensor is connected correctly. 2.Check if the Throttle position sensor is adjusted.
4	P1121	Throttle position sensor output range problem	2	1.Make sure if the connector of Throttle position sensor is connected correctly. 2.Check if the Throttle position sensor is adjusted.

## 5. FUEL INJECTION SYSTEM

### Failure Code

Blink	Failure Codes	Fault description	Priority	Fault management
5	P1122	Throttle position sensor movement speed problem	2	<ol style="list-style-type: none"> <li>1. Make sure if the connector of Throttle position sensor is connected correctly.</li> <li>2. Check if the Throttle position sensor is adjusted.</li> </ol>
6	P0560	Battery voltage malfunction	1	<ol style="list-style-type: none"> <li>1. Check if the battery voltage is lower or higher.</li> <li>2. Check if the charge system is malfunction.</li> </ol>
7	P0110	Inlet air temperature sensor or electric circuit malfunction	2	<ol style="list-style-type: none"> <li>1. Check if the connector of Inlet air temperature sensor loosen.</li> <li>2. Check if the resistance of sensor is normal .</li> </ol>
8	P0410	Idle air valve or electric circuit malfunction	2	<ol style="list-style-type: none"> <li>1. Check if the connector of Idle air valve loosen.</li> <li>2. Check if the resistance of valve is normal.</li> </ol>
9	P0505	Idle speed volume control range	2	<ol style="list-style-type: none"> <li>1. Check if the opening angle is over 180° for Idle air valve.</li> <li>2. Check if the opening angle is malfunction.</li> </ol>
10	P0251	Injector or electric circuit	2	<ol style="list-style-type: none"> <li>1. Check if the connector of Injector is loosen.</li> <li>2. Check if the ECU send signal to Injector.</li> <li>3. Check if the power source and resistance of Injector are malfunction.</li> </ol>

## 5. FUEL INJECTION SYSTEM

### Failure Code

Blink	Failure Codes	Fault description	Priority	Fault management
11	P0350	Ignition coil or electric circuit malfunction	2	<ol style="list-style-type: none"> <li>1. Check if the connector of ignition coil is loosen.</li> <li>2. Check if the ECU send signal to Ignition coil.</li> <li>3. Check if the power source and resistance is malfunction.</li> </ol>
12	P0230	Fuel pump relay or electric circuit malfunction	2	<ol style="list-style-type: none"> <li>1. Check if the connector of relay is loosen.</li> <li>2. Check if the ECU send signal to relay.</li> <li>3. Check the fuel pump relay resistance</li> </ol>
13	P0219	Engine speed is over than top speed	2	Check if the belt of CVT is broken.
14	P1560	Sensor don't receive power source from ECU	2	<ol style="list-style-type: none"> <li>1. Check if ECU output DC5V to sensor.</li> <li>2. Check if the power source of all sensor is DC5V.</li> <li>3. Replace a new ECU if the CELP still blinks even the output power source of ECU is normal.</li> </ol>
15	P0700	Engine starting speed exceed CVT speed limited	2	<ol style="list-style-type: none"> <li>1. Check if the throttle wire locked.</li> <li>2. Check if the position of throttle screw is correct.</li> <li>3. Check if the belt of CVT is broken.</li> </ol>
16	P0115	Engine temperature sensor or electric circuit malfunction	2	<ol style="list-style-type: none"> <li>1. Check if the connector of sensor is loosen.</li> <li>2. Check if ECU pin is broken.</li> <li>3. Check if the resistance of sensor is malfunction.</li> </ol>
17	P1561	Temperature gauge electric circuit malfunction	2	Don't use it at present.

## 5. FUEL INJECTION SYSTEM

### Failure Code

Blink	Failure Codes	Fault description	Priority	Fault management
18	P0650	CELP electric circuit malfunction	3	1. Check if the lamp of CELP is broken. 2. Check if wires of CELP is broken.
21	P0105	Atmospheric Pressure Sensor or electric Circuit Malfunction	2	1. Check if the connector of sensor is loosen. 2. Check if ECU pin is broken. 3. Check if voltage of sensor is fit in specification.
22	P1110	Roll sensor or electric circuit malfunction	2	1. Check if the sensor installation direction is correct. 2. Check if voltage of sensor is fit in specification. 3. Check if ECU pin is broken.
23	P0136	O2 sensor malfunction	1	1. Check if the connector of sensor is loosen. 2. Check if ECU pin is broken.
24	P0141	O2 sensor heater malfunction	1	1. Check if the connector of sensor is loosen. 2. Check if ECU pin is broken. 3. Check if the resistance of sensor is malfunction.
25	P0171	O2 sensor electric circuit malfunction	1	1. Check if the connector of sensor is loosen. 2. Check if O2 sensor is blocked. 3. Don't follow a routine maintenance.

## 5. FUEL INJECTION SYSTEM

---

### ECU

There are 36 pins attaching the ECU.  
Part number: 3920A-LHB6-900

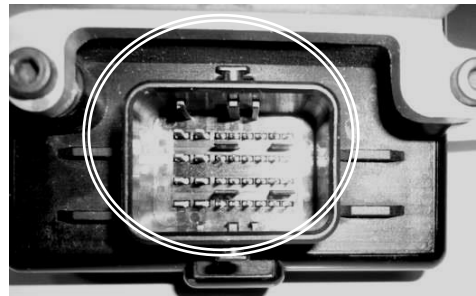

### Voltage inspection

Connect the meter (+) probe to the F4(R/W) wire and the meter (-) probe to the H4(G/B) wire to measure the voltage.



MAP content (edition issue no.)



## 5. FUEL INJECTION SYSTEM

---

### FUEL PUMP

Connect the meter (+) probe to the red/black wire and the meter (-) probe to the green wire to measure the voltage from the ECU input to fuel pump unit.

Standard : 8~16 V (Battery volt)

To measure the resistance of the fuel pump to see if it is short circuit or not.

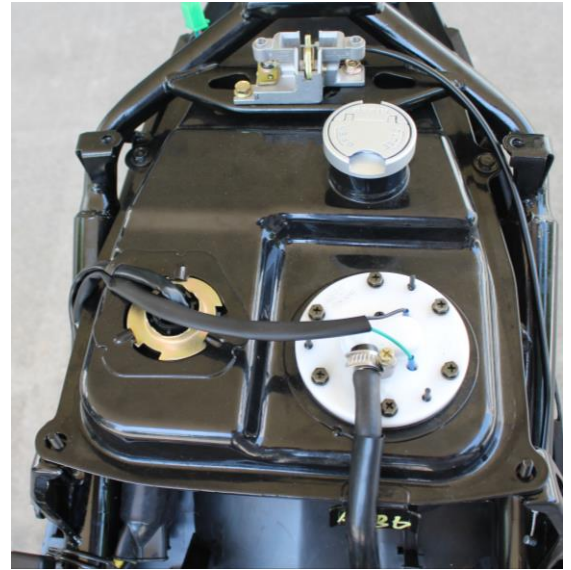

## 5. FUEL INJECTION SYSTEM

### T-MAP(Manifold Air Temperature Pressure) Sensor

Connect the PDA or Fi diagnostic tool.  
 Enter the Data Analyze  
 Check if the manifold pressure data is malfunction.  
 Turn the ignition switch to the "ON" position.  
 If data is incorrect, and the T-map sensor is problem.



**Standard : 101.3 ±3 kpa on sea altitude**

The ambient pressure drop is about **12Kpa** according to the altitude raises.

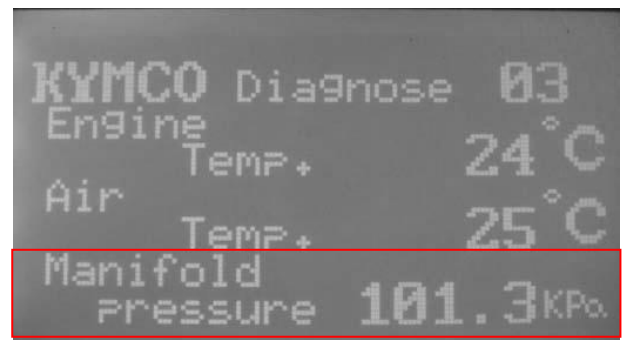

### TPS (Throttle Position Sensor)

Enter the Data Analyze  
 Check if the TPS position data is malfunction.  
 Turn the ignition switch to the "ON" position.  
 If data is incorrect even the Idle and throttle fully, the TPS is problem.



**Standard :**

Idle ~0 °                      0.23V ±0.05  
 Throttle fully ~90 °       > 3.27V

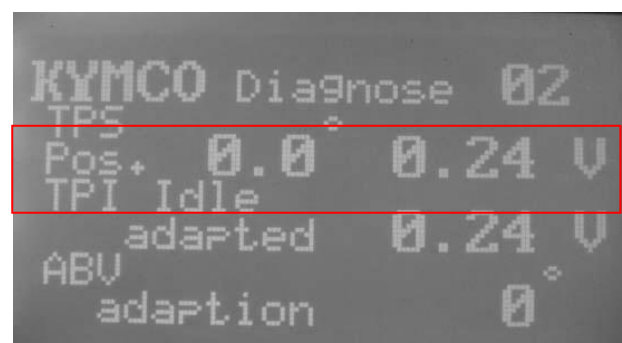



## 5. FUEL INJECTION SYSTEM

### ETS (Engine Temperature Sensor)

Connect the meter (+) probe to the V/G wire and the meter (-) probe to the G/L wire to measure the voltage

**Standard :  $5 \pm 0.25$  V**

Measure the resistance of the WTS

**Standard (20 °C/68 °F):  $2.075 \pm 10\%$  k $\Omega$**



### INJECTOR

Measure the resistance of the Injector  
**Standard (20°C/68°F): 10.6~15.9 $\Omega$**



## 5. FUEL INJECTION SYSTEM

### O2 SENSOR

Measure the resistance of the O2 sensor heater.  
(2 white wire pin)

**Standard (20 °C/68°F): 6.7 ~9.5Ω**



Connect the PDA or KYMCO Fi diagnostic tool.  
Enter the Data Analyze  
Check Page 05  
Turn the ignition switch to the “ON” position.  
Starting engine till the O2 heater activation is ON.  
If data is incorrect, the O2 sensor is problem.



## 5. FUEL INJECTION SYSTEM

### ROLL SENSOR

The engine should be stop when the vehicle incline over 65° for safety. When you place the vehicle back to normal position, you have to key-off and key-on the switch again, then it can be restarted.

**Standard:**

Normal: 0.4~1.4V

Fall down > 65° 3.7~4.4 V

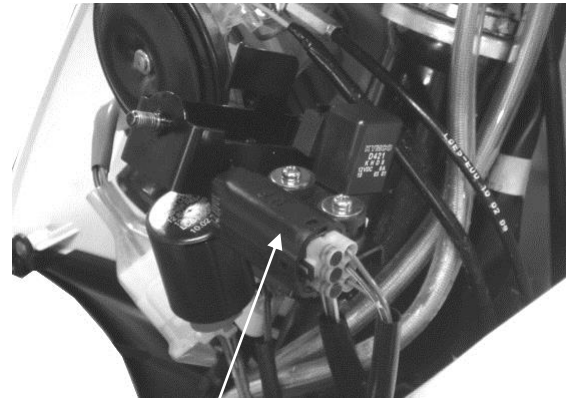

Roll sensor



### TP SCREW

Don't adjust the TP screws, they should be adjusted by KYMCO.

If TP screw lost of the original position, it may cause to unstable problem.

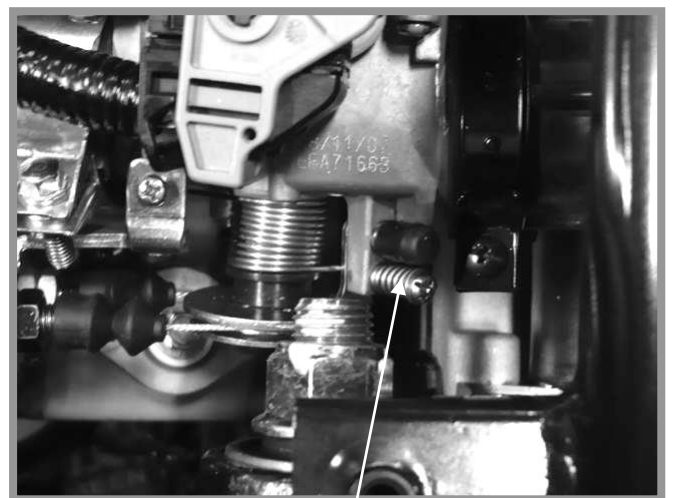

TP screws

## 5. FUEL INJECTION SYSTEM

Connect the PDA or Fi diagnostic tool.

Enter the Data Analyze

Check if the ignition advance data is malfunction.

Turn the ignition switch to the “ON” position.

Starting engine till the temperature up to 80 °C.

If the figure is over **20°**, you should adjust the air bypass screw 1~1.5 turns in counterclockwise.

Don't adjust the air bypass adjustment screw, it may cause to unstable problem.

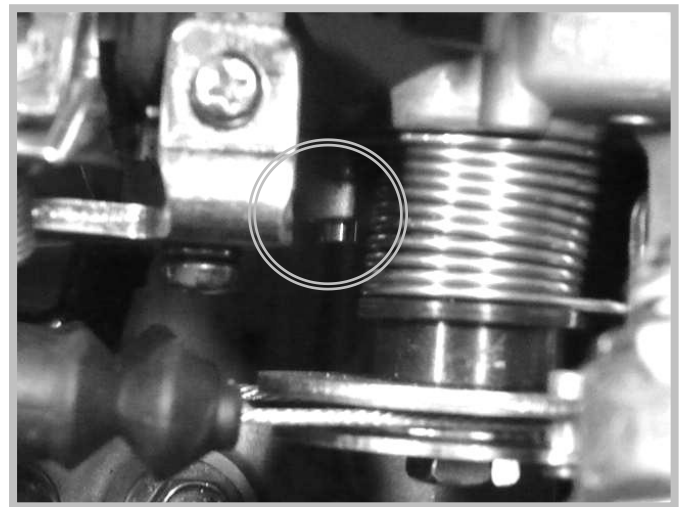
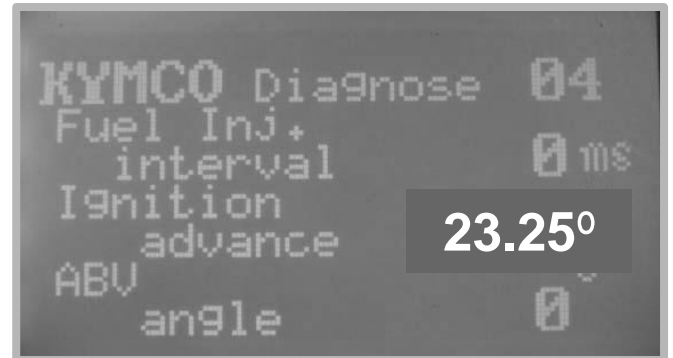

### TPI / ABV Initialization

After replacing throttle body or engine overhauled, it cause to the efficiency of air intake be changed, so should do the TPI/ABV initialization process.

1. When the scooter is working, turn off the ignition switch and turn on again (keep the engine is off).
2. Touch this pink wire to the negative point of battery or the earth of body frame to complete TPI ABV resetting.

### Attention

Disconnect the pink wire immediately after shorting.

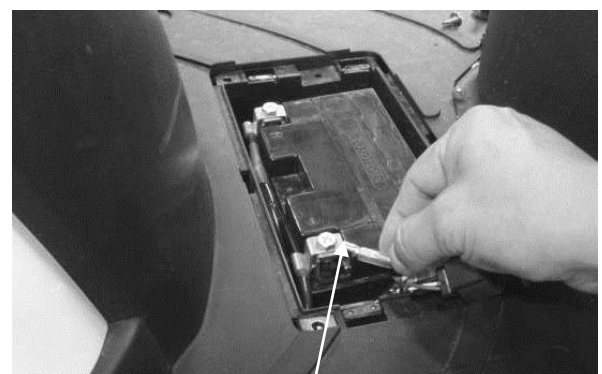

Reset wire (Pink)

## 5. FUEL INJECTION SYSTEM

### DIAGNOSTIC REPORT

Reason of repair: <input type="checkbox"/> Maintenance <input type="checkbox"/> Breakdown			
Item	Data	Reference	Memo
ECU Version	ECU No		
	Hardware Ver		
	Software Ver	QK0A00	
	Calibration Ver	04ALK1E4TB	
	Model Name	ALK1	
DTC	Active		
	Occurred		
	History		
(Cool Engine) Engine Stop	Air Temp.(°C)	environ.temp ± 2 °C	
	Engine Temp.(Cooling)	environ.temp ± 2 °C	
	Atom. Pressure (Kpa.)	101.3 ± 3 kPa	The ambient pressure drop about 12kpa at the altitude every 1000m raised
	Throttle Position (%)	Below0° / below90°	
	Throttle Position (V)	0.23V ± 0.05 / >3.65±1V	IDLE/Throttle fully
	TPI Idle Mean (V)	0.23±0.05	IDLE/Throttle fully
	Battery Volt (V)	>12 V	
	Idle Speed Set point (RPM)	---	
	ISCAdapMean (°)	---	
	Cut Out Switch Volt (V)	0.4 ~ 1.44 V	3.7 ~ 4.7 V(Over 65°)
Accumulated Eng. Run Time (Hr)	---		
(Hot Engine) Before Repair	EngineSpeed IDLE(rpm)	2000 ± 100 rpm	
	MAPSample (kPa)	52 ~ 68 kpa	
	Injection duration (ms)	1.9 ~ 3 ms	
	Ign. Advance (°)	4 ~ 17 BTDC	
	Ign.Dwell duration (ms)	----	
	Air Temp.(°C)	environ.temp ±2 °C	
	Engine Temp. (°C)	>95 °C	
	O <sup>2</sup> sensor voltage (V)	0 ~ 1 V	
	O <sup>2</sup> sensor heater (Yes/no)	YES	
	O <sup>2</sup> sensor correct	±15%	
	IDLE CO(%)	0.4 ~ 2 %	Engine warm up to 80~90 °C
ABVAngDurMech (°)	< 140 °	>140 ° The scooter with exchange engine oil and clean throttlly body >180 ° The scooter must clean throttlly body	
(Hot Engine) After Repair	EngineSpeed IDLE(rpm)	2000 ± 100 rpm	80~90°C
	MAPSample (kPa)	52 ~ 68 kpa	80~90°C
	Injection duration (ms)	1.9 ~ 3 ms	80~90°C
	Ign. Advance (°)	4 ~ 17 BTDC	80~90°C
	Ign.Dwell duration (ms)	1.8~2.5 ms	Battery Volt (V) 14V-1.9~2.1ms, 12V-2.5~2.6ms
	Air Temp.(°C)	environ.temp ±2 °C	
	Engine Temp. (°C)	>95 °C	
	O <sup>2</sup> sensor voltage (V)	0 ~ 1 V	
	O <sup>2</sup> sensor heater (Yes/no)	YES	
	O <sup>2</sup> sensor correct	±20	
	IDLE CO(%)	0.4 ~ 2 %	Engine warm up to 80~90 °C
ABVAngDurMech (°)	< 140 °	>140 ° The scooter with exchange engine oil and clean throttlly body >180 ° The scooter must clean throttlly body	
Repair description	Repair Process		

# Fi Diagnostic Tool Operation Instructions Part No. 3620A-LEB2-E00



- |                                       |                |
|---------------------------------------|----------------|
| 1 Model No.                           | 8 DATA Analyze |
| 2 Down Button                         | 9 DTC Inspect  |
| 3 DTC indicator (Failure codes)       | 10 ECU Version |
| 4 Enter or Exit                       |                |
| 5 Power indicator                     |                |
| 6 UP Button                           |                |
| 7 Adjust (TPI and ABV reset function) |                |

## DTC INSPECTION

Connect Fi diagnostic tool with the connector of harness wire located beside the Battery.

Press the "Enter" button



Check the software version

Press the "Enter" button and then turn to the first page.



Press the "Down" button to enter the DTC Inspect.



## 5. FUEL INJECTION SYSTEM

Press the "Enter" button to check the DTC number



Press the "Enter" button

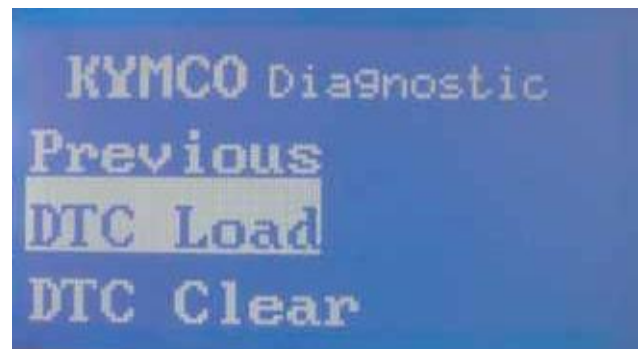

Press the "Enter" button

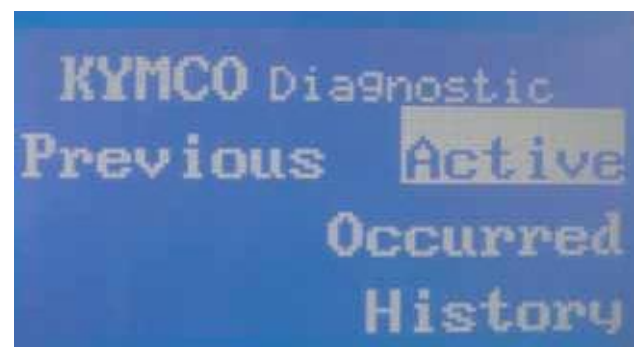

Display the DTC number of the DTC-List. Refer to DTC summary list.

Press the "Enter" button and then turn to the previous page





Press the "UP" button

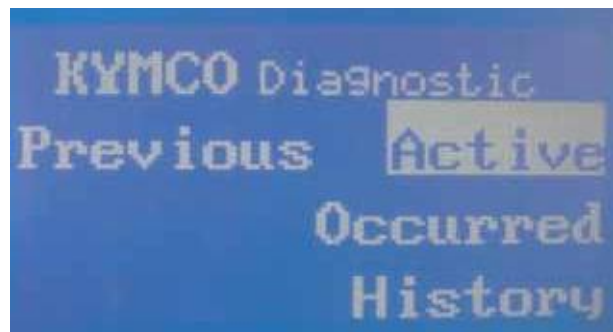

Press the "Enter" button and then turn to the previous page.

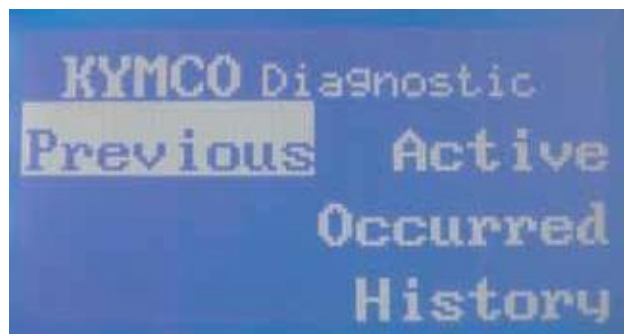

Press the "UP" button

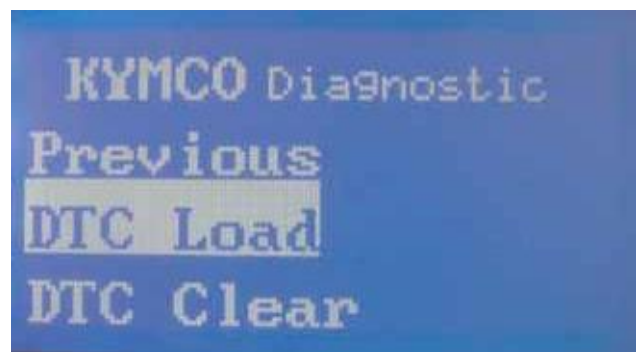

Press the "Enter" button and then turn to the first page.



## DTC CLEAR PROCEDURE

Choose "Load DTC"

Press the "Down" button

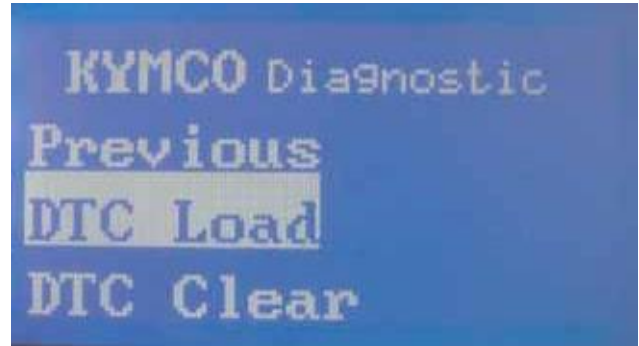

Press the "Enter" button

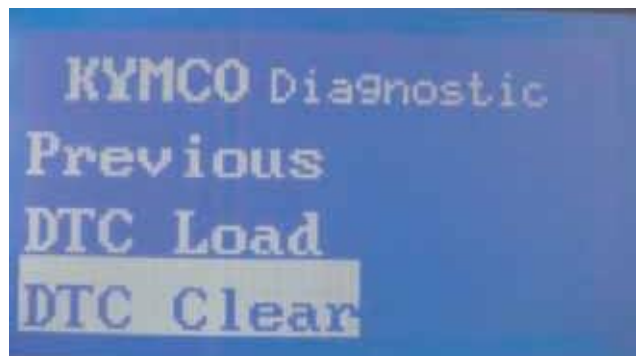

The DTC indicator is lighting at that time.



Clearing DTC until the DTC indicator is off.

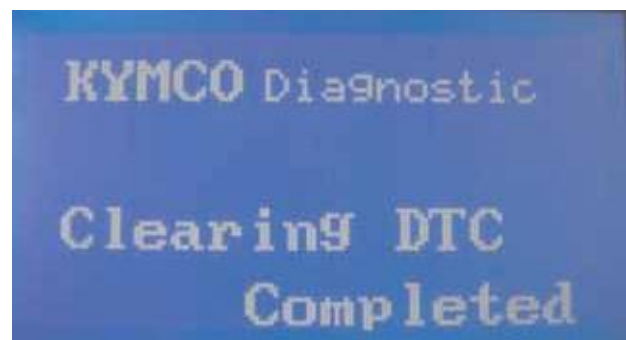

## DATA ANALYSIS

Choose "Data Analyze"

Press the "Enter" button to enter page 01.



The figure includes the engine speed, idle speed and the battery voltage.

Refer to standard specification.

Press the "Down" button to enter page 02.

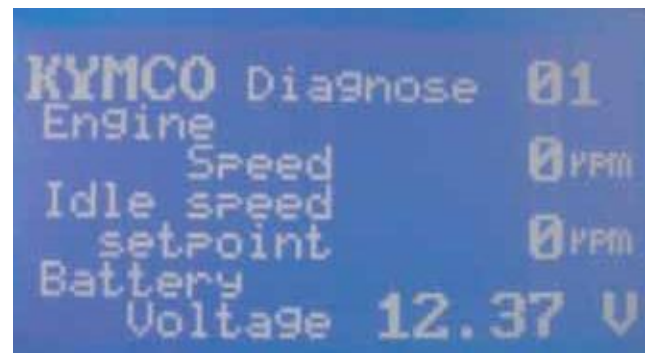

The figure includes TPS position, TPI idle adapted voltage and TPI WOT adapted (Throttle grip fully opened).

Refer to standard specification.

Press the "Down" button to enter page 03.

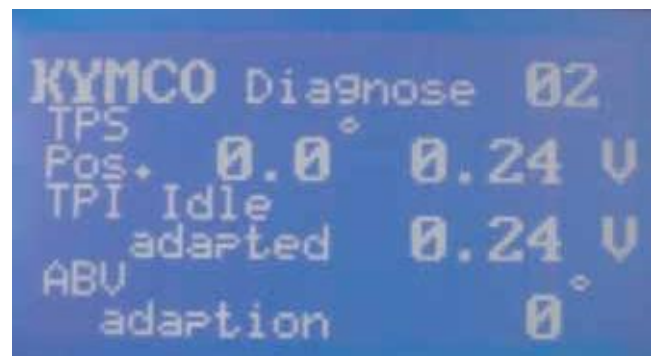

The figure includes engine working temperature, atmosphere pressure and Manifold pressure.

Refer to standard specifications on page 18-9.

Press the "Down" button to enter page 04.



## 5. FUEL INJECTION SYSTEM

The figure includes fuel injector interval, ignition advance angle and ABV angle. Refer to standard specification. Press the "Down" button to enter page 05.

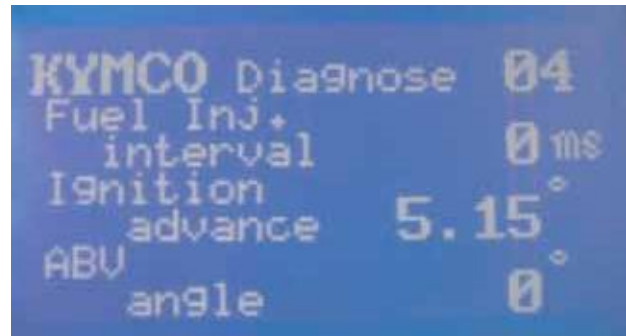

The figure includes O2 sensor voltage, O2 heater working condition and O2 correction.

Refer to standard specification.

Press the "Down" button to enter page 06.



The figure includes rollover voltage.

Refer to standard specification.

Press the "Down" button to enter page 07.



The figure includes ECU counter hours.

Press the "UP" button to the first page.

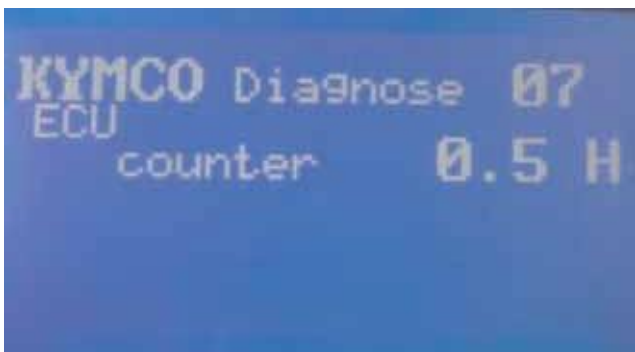

## 5. FUEL INJECTION SYSTEM

### ADJUST

Need to process the TPI/ABV reset after replacing a new ECU or clean Throttle Body.  
To make ECU set up and set up initially  
Choose "Adjust"

Press the "Enter" button to TPI/ABV Reset



Press the "Enter" button

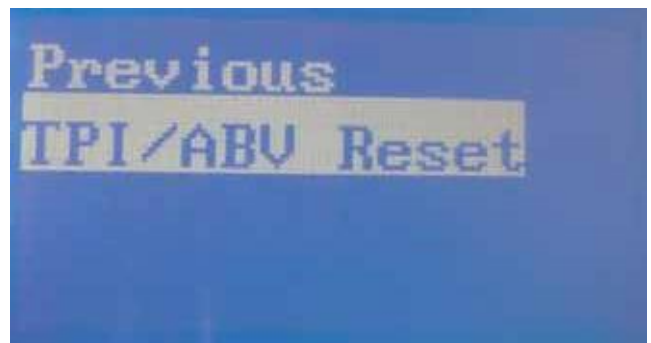

Please turn the ignition switch to the "OFF" position and then switch ON.

TPI/ABV reset is completed.

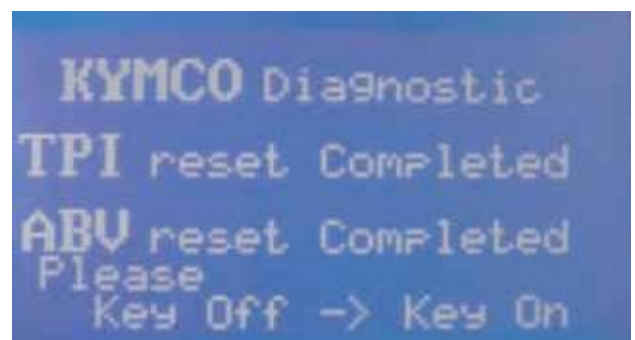

# 6. ENGINE REMOVAL/INSTALLATION

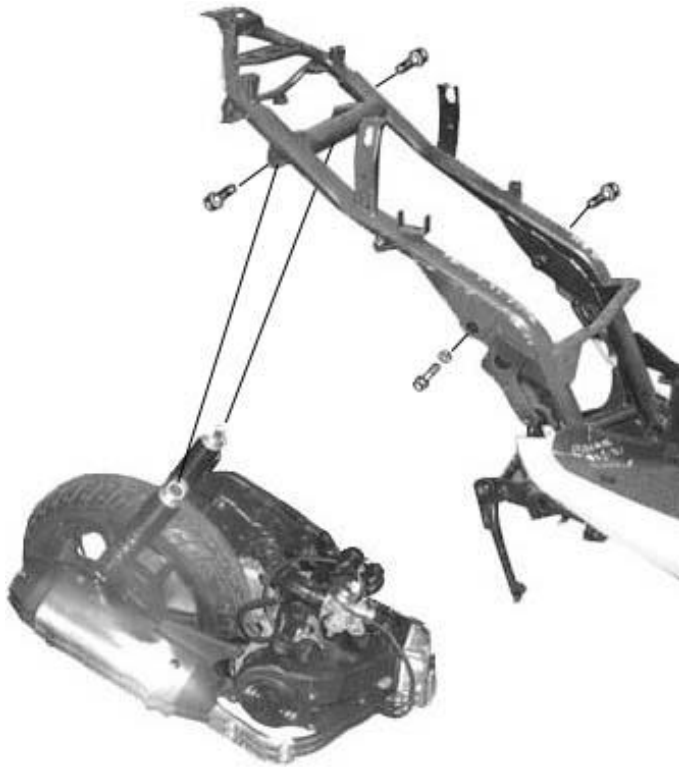

6

KP10AA(IT) F21

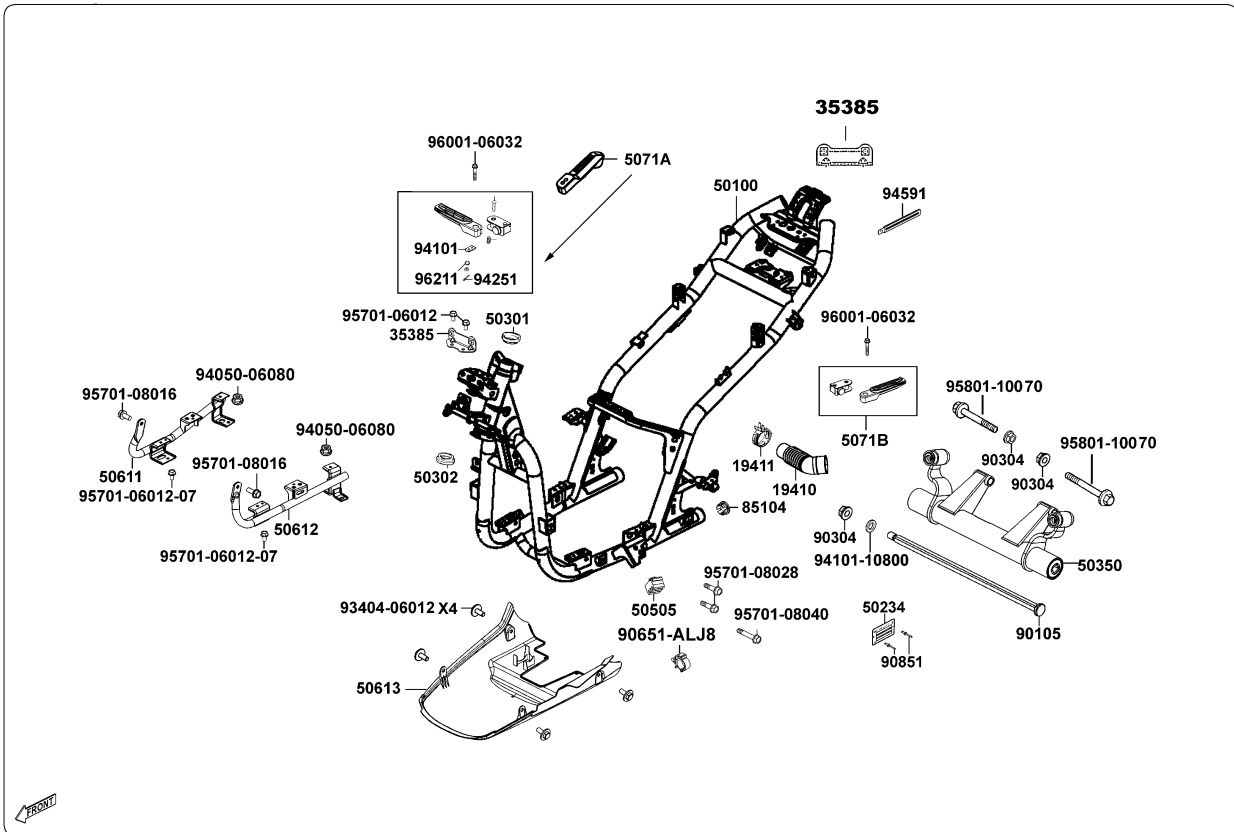

## 6. ENGINE REMOVAL/INSTALLATION

---

SERVICE INFORMATION .....	6-1	ENGINE INSTALLATION .....	6-4
ENGINE REMOVAL .....	6-2		

### SERVICE INFORMATION

#### GENERAL INSTRUCTIONS

- A floor jack or other adjustable support is required to support and maneuver the engine. Be careful not to damage the motorcycle body, cables and wires during engine removal.
- Use shop towels to protect the motorcycle body during engine removal.
- Parts requiring engine removal for servicing:
  - Crankcase
  - Crankshaft

## 6. ENGINE REMOVAL/INSTALLATION

### ENGINE REMOVAL

Disconnect the battery negative cable.  
Remove the frame body cover.  
Disconnect the engine negative cable.  
Disconnect the spark plug high tension wire.  
Disconnect the auto bystarter wire connector.



Auto Bystarter Wire Connector

Disconnect the starter motor cable from the starter relay.  
Remove the spark plug cap and disconnect the ignition coil wire from the set plate.

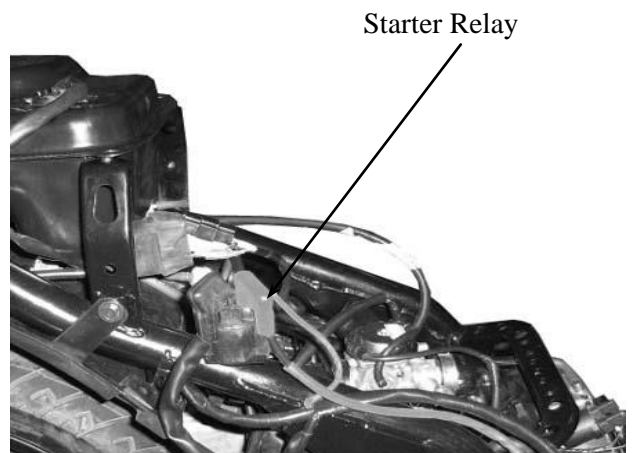

Starter Relay

Disconnect the fuel tube from the throttle body.  
Disconnect the throttle cable from the throttle body.

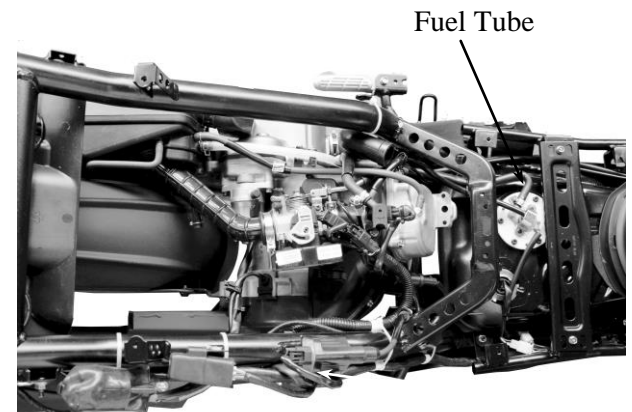

Fuel Tube

Loosen the belt of air cleaner connecting tube band screw and remove the connecting tube.

Connecting Tube

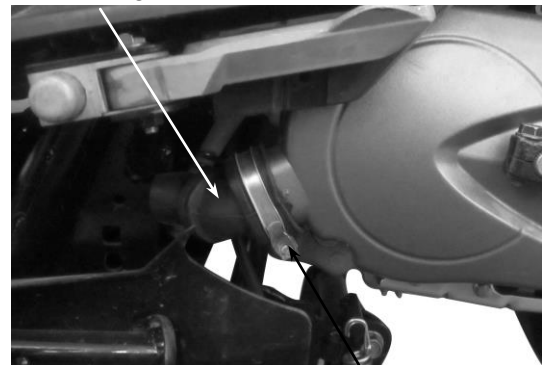

Screw



## 6. ENGINE REMOVAL/INSTALLATION

Remove the rear shock absorber lower mount bolt.

Rear Shock Absorber Lower Mount Bolt

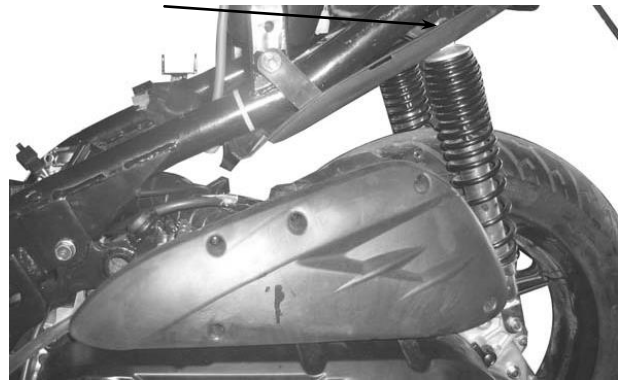

Remove the four bolts of A.C. generator cooling fan cover and cooling fan cover. Remove the engine mounting bolt and pull out the engine with the engine hanger bracket backward.

Engine Mounting Bolt

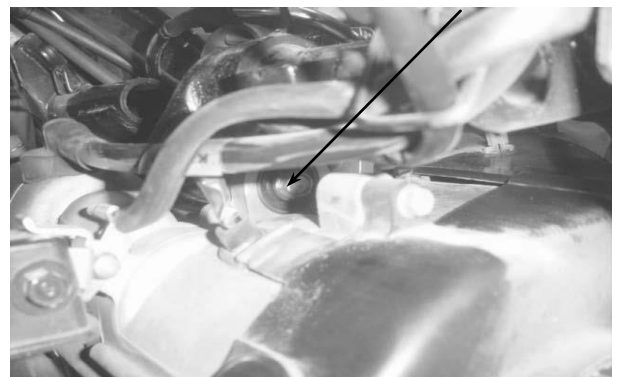

### ENGINE HANGER BRACKET REMOVAL

Remove the ignition coil from the engine hanger.  
Remove the engine hanger bracket bolt and nut.  
Remove the engine hanger bracket.

Engine Hanger Bracket

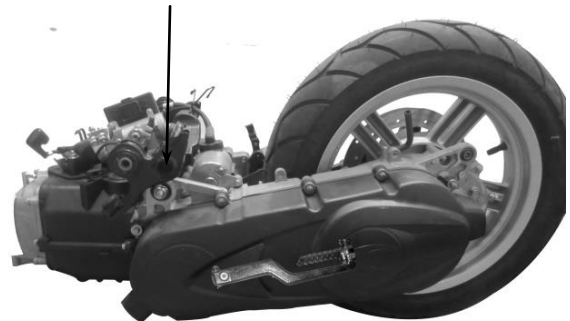

Inspect the engine hanger bushings and stopper rubbers for wear or damage.

Bushings

Stopper Rubbers

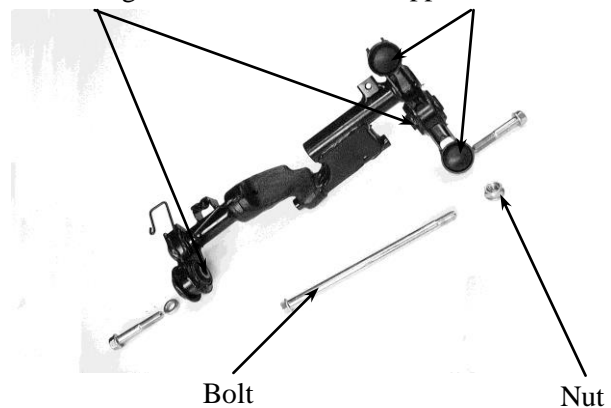

## 6. ENGINE REMOVAL/INSTALLATION

### ENGINE HANGER BRACKET INSTALLATION

Install the engine hanger bracket to the engine.  
Install the engine hanger bracket bolt and tighten the nut.

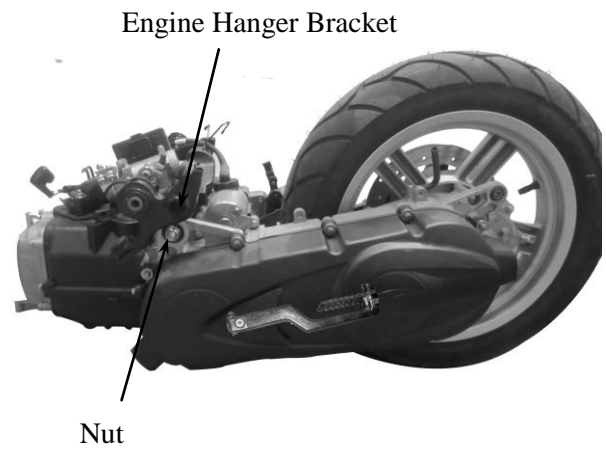

### ENGINE INSTALLATION

Install the engine and tighten the engine mounting bolt.

**Torque:** 7.0kg-m

Tighten the rear shock absorber upper mount bolt.

**Torque:** 4.0kg-m

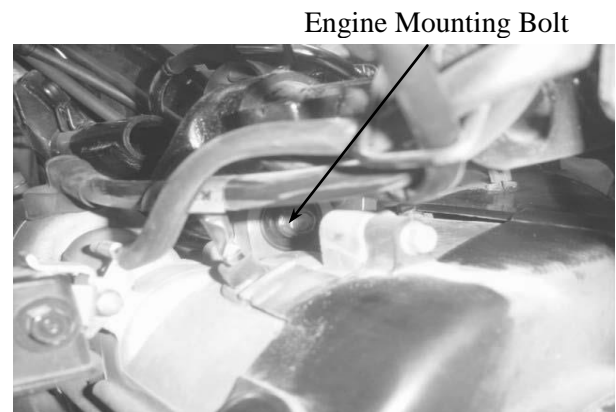

Install the removed parts in the reverse order of removal.

\* Route the wires and cables properly.

After installation, inspect and adjust the following:

- Throttle grip free play.
- Rear brake adjustment.

Rear Shock Absorber Lower Mount Bolt

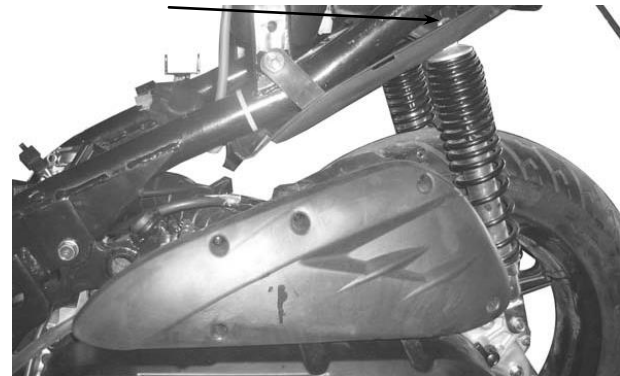

# 7. CYLINDER HEAD/VALVES

10AA(CN) E02

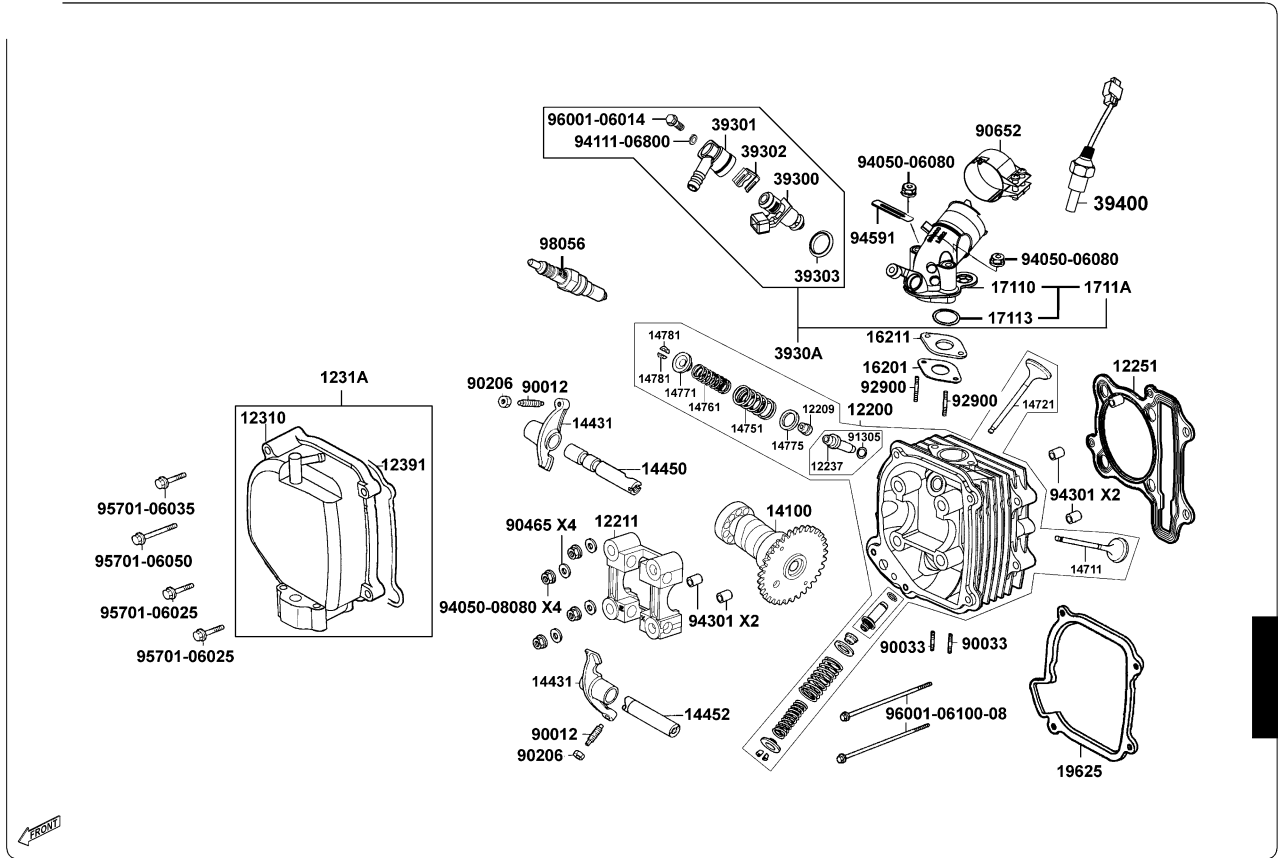

7

KL10CA(IT) E03

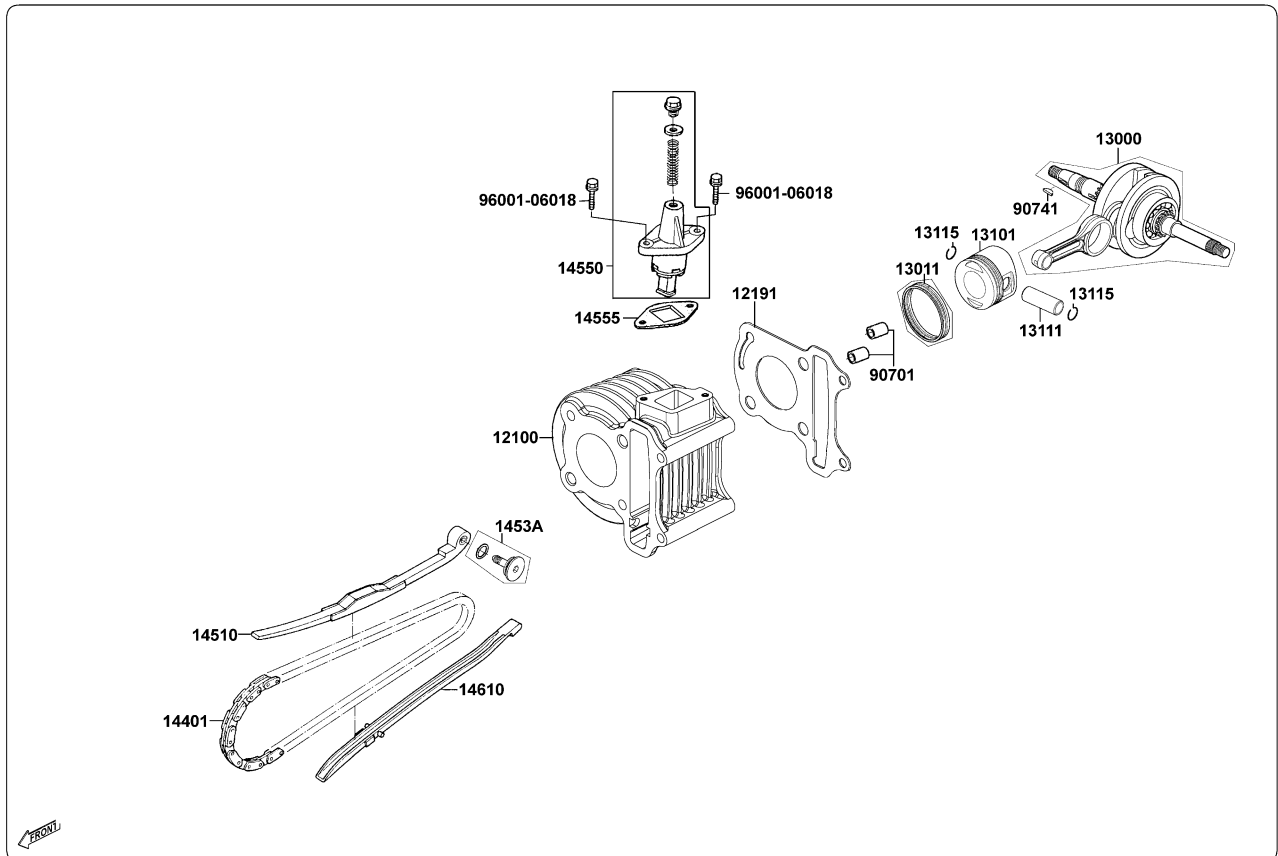

## 7. CYLINDER HEAD/VALVES

SERVICE INFORMATION.....	7-1	CYLINDER HEAD DISASSEMBLY .....	7-7
TROUBLESHOOTING.....	7-2	CYLINDER HEAD ASSEMBLY .....	7-8
CAMSHAFT REMOVAL.....	7-3	CYLINDER HEAD INSTALLATION.....	7-8
CYLINDER HEAD REMOVAL .....	7-5	CAMSHAFT INSTALLATION .....	7-9

### SERVICE INFORMATION

#### GENERAL INSTRUCTIONS

- The cylinder head can be serviced with the engine installed in the frame.
- When assembling, apply molybdenum disulfide grease or engine oil to the valve guide movable parts, valve arm and camshaft sliding surfaces for initial lubrication.
- The camshaft is lubricated by engine oil through the cylinder head engine oil passages. Clean and unclog the oil passages before assembling the cylinder head.
- After disassembly, clean the removed parts and dry them with compressed air before inspection.
- After removal, mark and arrange the removed parts in order. When assembling, install them in the reverse order of removal.

#### SPECIFICATIONS

Item		Standard (mm)	Service Limit (mm)
Valve clearance (cold)	IN	0.04	—
	EX	0.04	—
Cylinder head compression pressure		14kg/cm <sup>2</sup>	
Cylinder head warpage		—	0.05
Camshaft cam height	IN	25.706	25.306
	EX	25.564	25.164
Valve rocker arm I.D.	IN	10.000~10.015	10.10
	EX	10.000~10.015	10.10
Valve rocker arm shaft O.D.	IN	9.972~9.987	9.91
	EX	9.972~9.987	9.91
Valve seat width	IN	1.0	1.8
	EX	1.0	1.8
Valve stem O.D.	IN	4.975~4.990	4.90
	EX	4.955~4.970	4.90
Valve guide I.D.	IN	5.000~5.012	5.03
	EX	5.000~5.012	5.03
Valve stem-to-guide clearance	IN	0.010~0.037	0.08
	EX	0.030~0.057	0.10

## 7. CYLINDER HEAD/VALVES

---

### TORQUE VALUES

Cylinder head nut	1.8~2.2kgf-m	Apply engine oil to threads
Valve clearance adjusting nut	0.7~1.1kgf-m	Apply engine oil to threads

### SPECIAL TOOLS

Valve spring compressor

### TROUBLESHOOTING

- The poor cylinder head operation can be diagnosed by a compression test or by tracing engine top-end noises.

#### Poor performance at idle speed

- Compression too low

#### Compression too low

- Incorrect valve clearance adjustment
- Burned or bend valves
- Incorrect valve timing
- Broken valve spring
- Poor valve and seat contact
- Leaking cylinder head gasket
- Warped or cracked cylinder head
- Poorly installed spark plug

#### Compression too high

- Excessive carbon build-up in combustion chamber

#### White smoke from exhaust muffler

- Worn valve stem or valve guide
- Damaged valve stem seal

#### Abnormal noise

- Incorrect valve clearance adjustment
- Sticking valve or broken valve spring
- Damaged or worn camshaft
- Worn cam chain guide
- Worn camshaft and rocker arm

## 7. CYLINDER HEAD/VALVES

### CAMSHAFT REMOVAL

Remove the center cover.  
Remove the four cylinder head cover bolts to remove the cylinder head cover.  
Remove the two nuts attaching the secondary air inlet tube.

Remove the cam chain tensioner cap screw and the O-ring.

Turn the cam chain tensioner screw clockwise to tighten it.

Turn the flywheel counterclockwise so that the "T" mark on the flywheel aligns with the index mark on the crankcase to bring the round hole on the camshaft gear facing up to the top dead center on the compression stroke.

Cylinder Head Cover

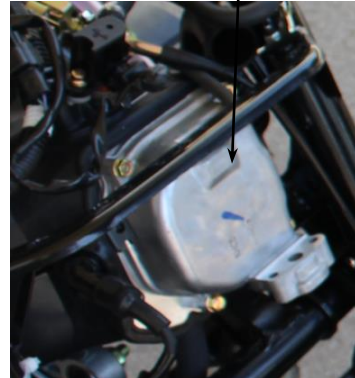

O-ring

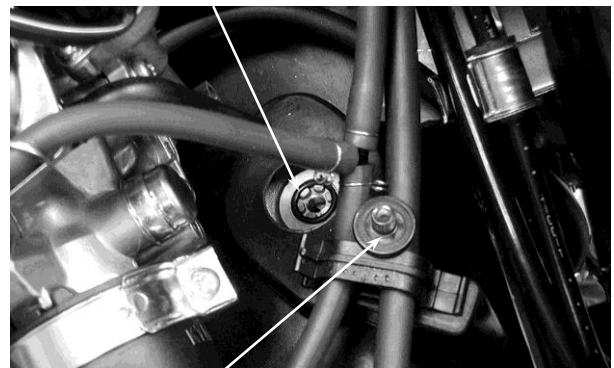

Screw

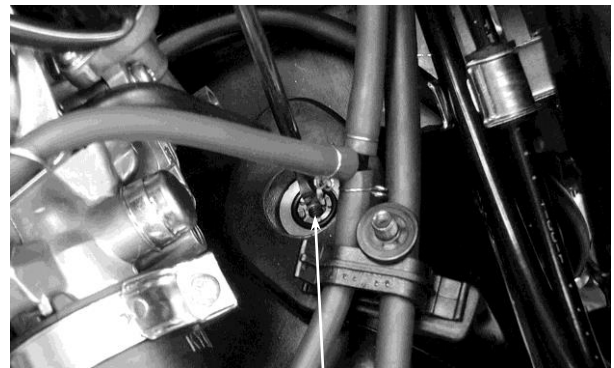

Tensioner Screw

Camshaft Gear

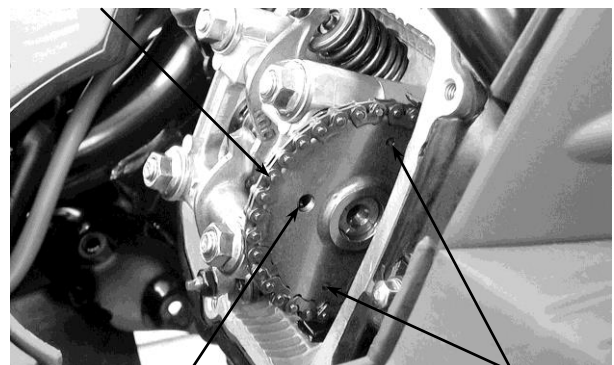

Round Hole

Punch Marks

## 7. CYLINDER HEAD/VALVES

Remove the two cylinder head bolts.  
Remove the four cylinder head nuts and washers.

\* Diagonally loosen the cylinder head nuts in 2 or 3 times.

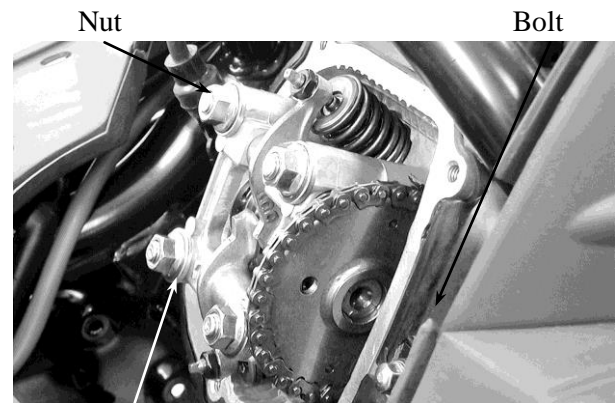

Washer

Remove the camshaft holder and dowel pins.

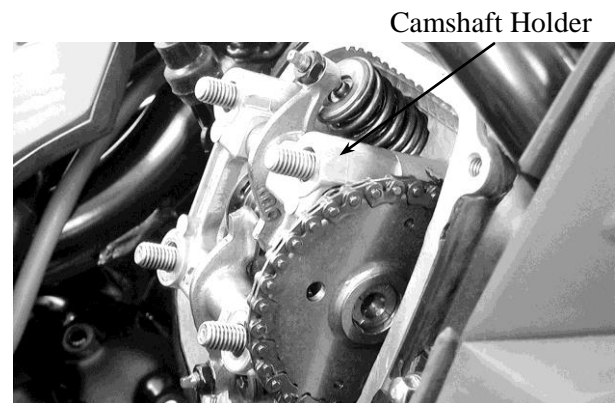

Remove the camshaft gear from the cam chain and remove the camshaft.

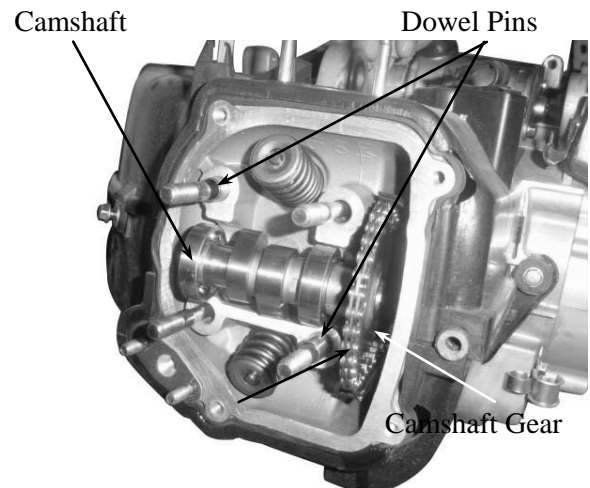

### CAMSHAFT INSPECTION

Check each cam lobe for wear or damage.  
Measure the cam lobe height.

#### Service Limits:

IN : 26.038mm replace if below

EX: 25.407mm replace if below



## 7. CYLINDER HEAD/VALVES

Check each camshaft bearing for play or damage. Replace the camshaft assembly with a new one if the bearings are noisy or have excessive play.

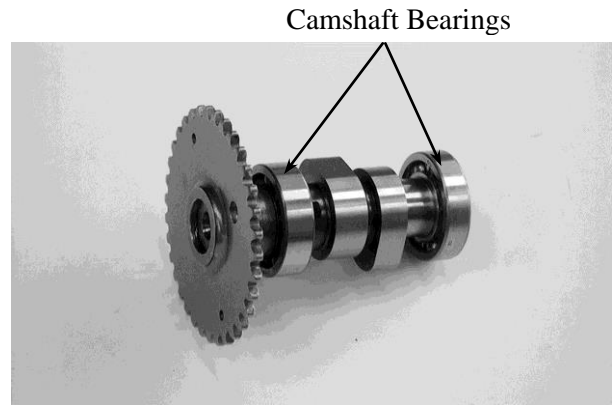

### CAMSHAFT HOLDER DISASSEMBLY

Take out the valve rocker arm shafts using a 5mm bolt.  
Remove the valve rocker arms.

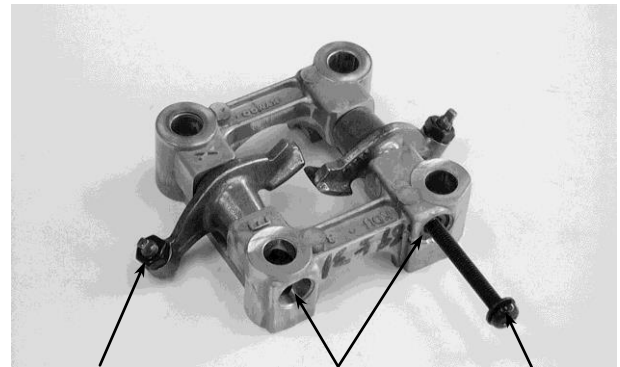

Rocker Arm    Rocker Arm Shaft    5mm Bolt

### CAMSHAFT HOLDER INSPECTION

Inspect the camshaft holder, valve rocker arms and rocker arm shafts for wear or damage.

\* If the valve rocker arm contact surface is worn, check each cam lobe for wear or damage.

Camshaft Holder

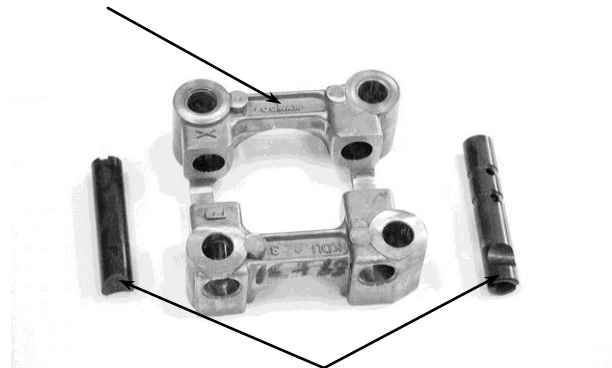

Rocker Arm Shafts

Measure the I.D. of each valve rocker arm.

#### Service Limits:

IN: 10.10mm replace if over

EX: 10.10mm replace if over

Measure each rocker arm shaft O.D.

#### Service Limits:

IN: 9.91mm replace if over

EX: 9.91mm replace if over





## 7. CYLINDER HEAD/VALVES

### CYLINDER HEAD REMOVE

Remove the camshaft.  
Remove the carburetor.  
Remove the exhaust muffler.  
Remove the carburetor intake manifold.  
Remove the cooling fan cover.  
Remove the engine cover bolts and screws.  
Separate the engine cover joint claws.

Intake Manifold

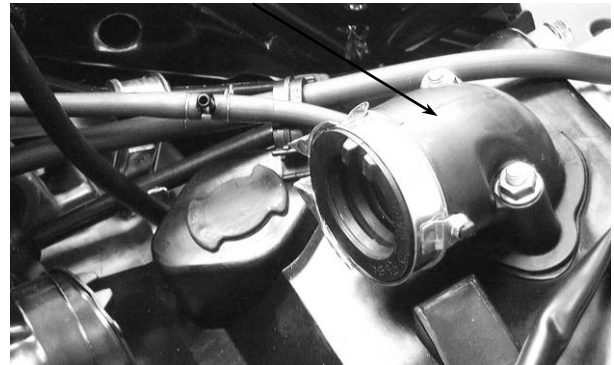

Remove the cylinder head.

Cylinder Head

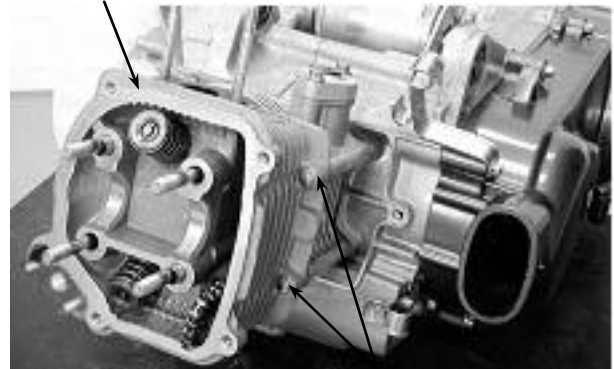

Bolts

Remove the dowel pins and cylinder head gasket.  
Remove the cam chain guide.

Dowel Pins

Cylinder Head Gasket

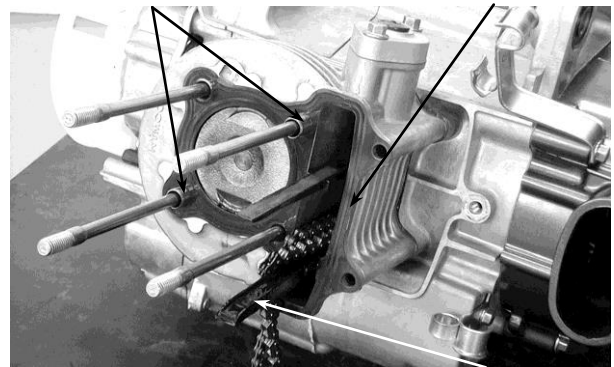

Cam Chain Guide

Remove all gasket material from the cylinder mating surface.

- \* Avoid damaging the cylinder mating surface.
- \* Be careful not to drop any gasket material into the engine.

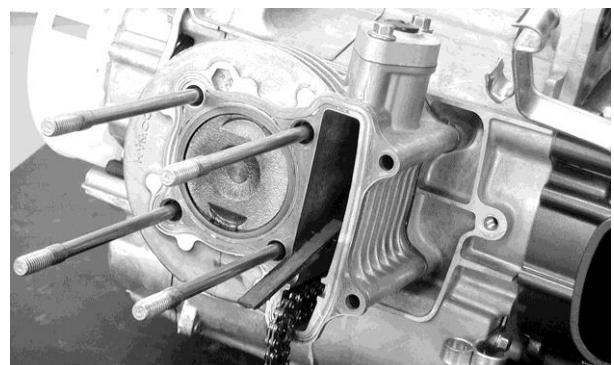

## 7. CYLINDER HEAD/VALVES

### CYLINDER HEAD DISASSEMBLY

Remove the valve spring cotters, retainers, springs, spring seats and valve stem seals using a valve spring compressor.

- \* Special
- Be sure to compress the valve springs with a valve spring compressor.
  - Mark all disassembled parts to ensure correct reassembly.

Special

Valve Spring Compressor

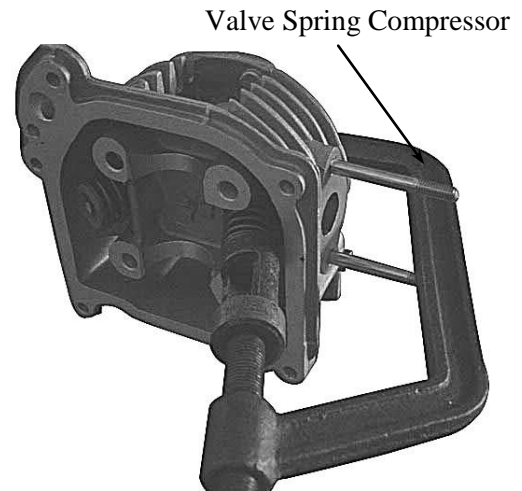

Remove carbon deposits from the combustion chamber.

Clean off any gasket material from the cylinder head mating surface.

- \* Special
- Be careful not to damage the cylinder head mating surface.

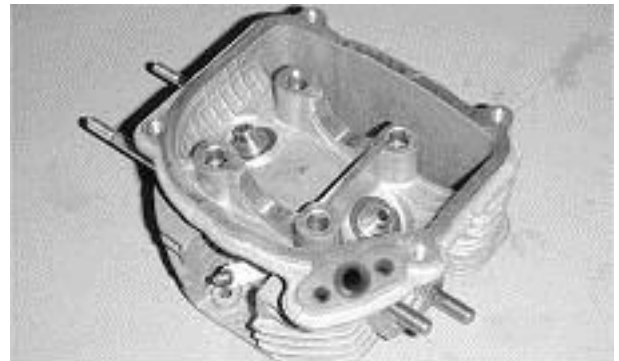

### INSPECTION

#### CYLINDER HEAD

Check the spark plug hole and valve areas for cracks.

Check the cylinder head for warpage with a straight edge and feeler gauge.

**Service Limit:** 0.05mm repair or replace if over

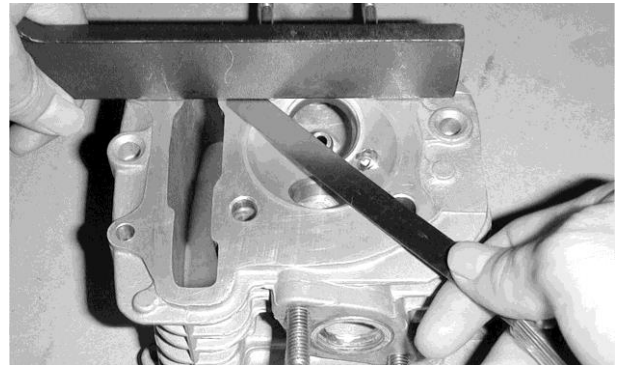

#### VALVE SPRING FREE LENGTH

Measure the free length of the inner and outer valve springs.

**Service Limits:**

Inner : 30.1mm replace if below

Outer : 33.3mm replace if below

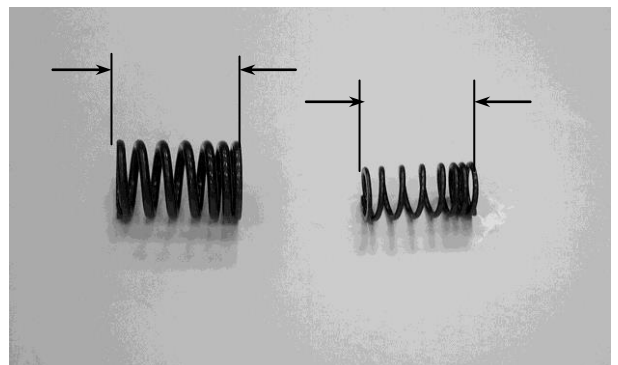

## 7. CYLINDER HEAD/VALVES

### VALVE /VALVE GUIDE

Inspect each valve for bending, burning, scratches or abnormal stem wear.

Check valve movement in the guide.

Measure each valve stem O.D.

#### Service Limits:

IN : 4.90mm replace if below

EX: 4.90mm replace if below

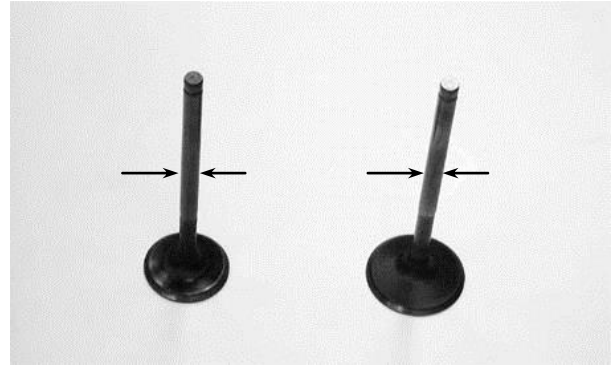

Measure each valve guide I.D.

**Service Limits:** IN : 5.03mm replace if over

EX: 5.03mm replace if over

Subtract each valve stem O.D. from the corresponding guide I.D. to obtain the stem-to-guide clearance.

**Service Limits:** IN : 0.08mm replace if over

EX: 0.10mm replace if over

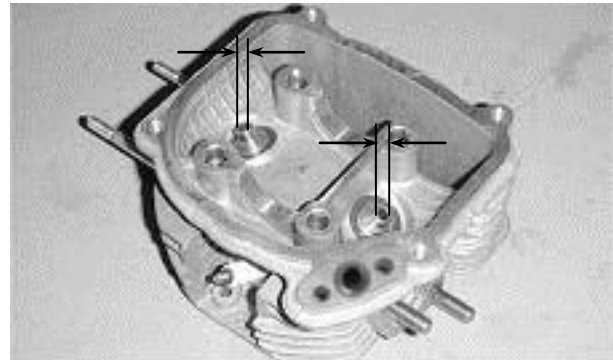

\* If the stem-to-guide clearance exceeds the service limits, replace the cylinder head as necessary.

### CYLINDER HEAD ASSEMBLY

Install the valve spring seats and valve stem seals.

\* Be sure to install new valve stem seals.

Lubricate each valve stem with engine oil and insert the valves into the valve guides. Install the valve springs and retainers.

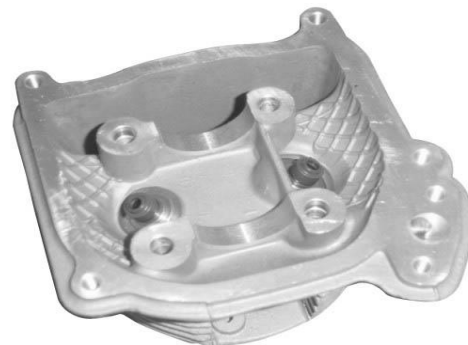

Compress the valve springs using the valve spring compressor, then install the valve cotters.

\* • When assembling, a valve spring compressor must be used.  
• Install the cotters with the pointed ends facing down from the upper side of the cylinder head.

Special

Valve Spring Compressor

Valve Spring Compressor

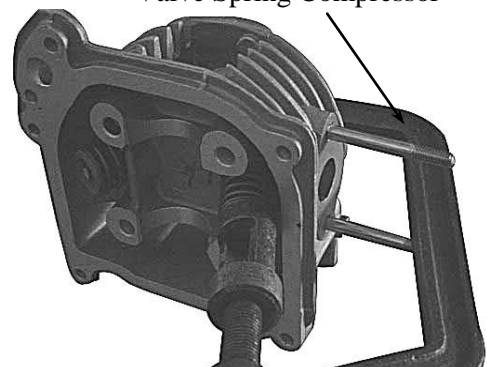

## 7. CYLINDER HEAD/VALVES

Tap the valve stems gently with a plastic hammer for 2~3 times to firmly seat the cotters.

\* Be careful not to damage the valves.

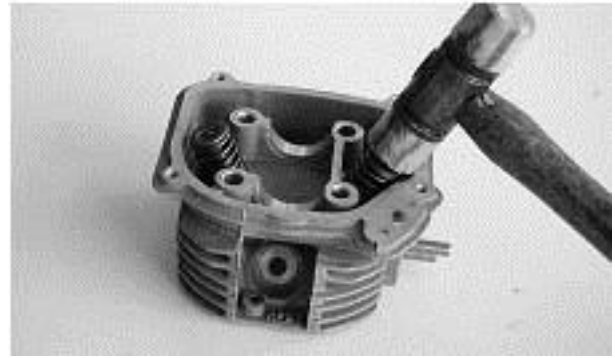

### CYLINDER HEAD INSTALLATION

Tighten the four stud bolts.

Install the dowel pins and a new cylinder head gasket.

Install the cam chain guide.

**Torque:** Stud Bolts :0.7~1.1kg-m

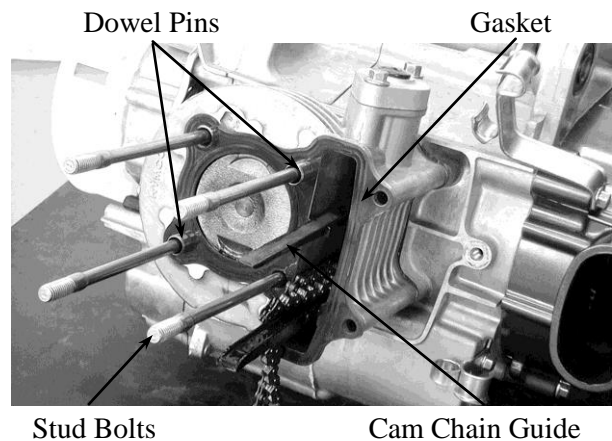

Install the cylinder head.

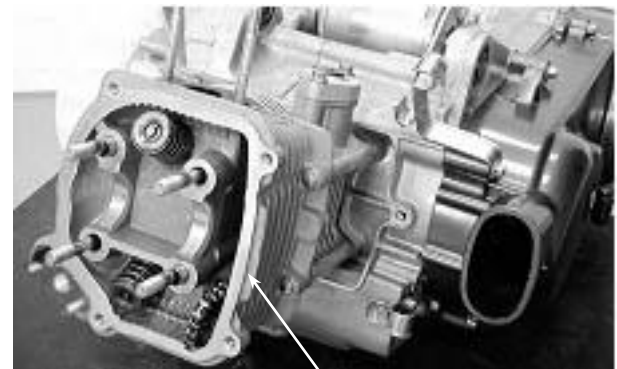

Cylinder Head

### CAMSHAFT HOLDER ASSEMBLY

Install the exhaust valve rocker arm to the "EX" mark side of the camshaft holder.

Install the intake valve rocker arm and the rocker arm shafts.

- \*
- Align the cutout on the front end of the intake valve rocker arm shaft with the bolt of the camshaft holder.
  - Align the cross cutout on the exhaust valve rocker arm shaft with the bolt of the camshaft holder.

Camshaft Holder

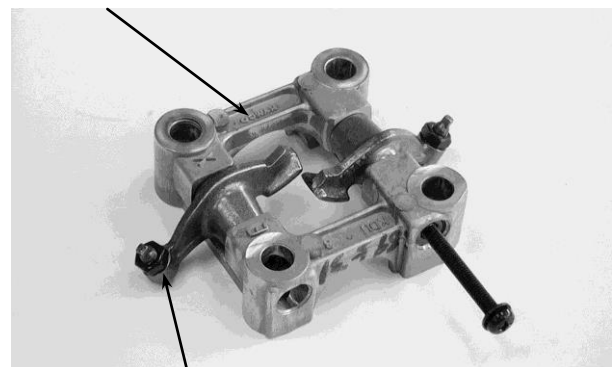

Valve Rocker Arm

## 7. CYLINDER HEAD/VALVES

### CAMSHAFT INSTALLATION

Turn the flywheel so that the “T” mark on the flywheel aligns with the index mark on the crankcase.

Keep the round hole on the camshaft gear facing up and align the punch marks on the camshaft gear with the cylinder head surface (Position the intake and exhaust cam lobes down.) and install the camshaft onto the cylinder head.

Install the cam chain over the camshaft gear.

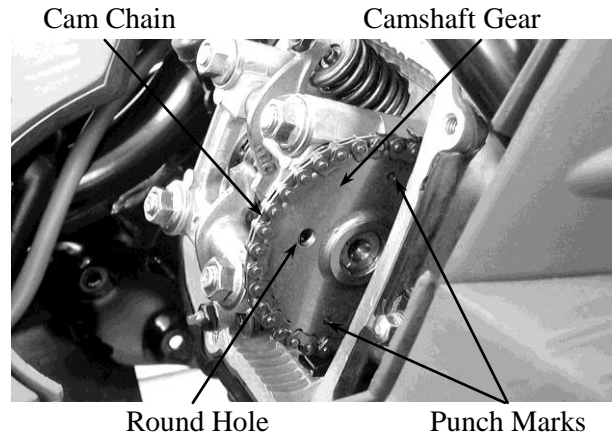

Install the dowel pins.

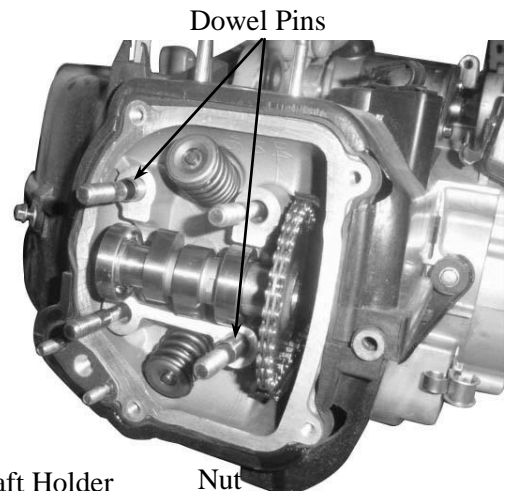

Install the camshaft holder, washers and nuts on the cylinder head.

Tighten the four cylinder head nuts and two bolts.

**Torque:** Cylinder head nut: 2.0kg-m

- \*
- Apply engine oil to the threads of the cylinder head nuts.
  - Diagonally tighten the cylinder head nuts in 2~3 times.

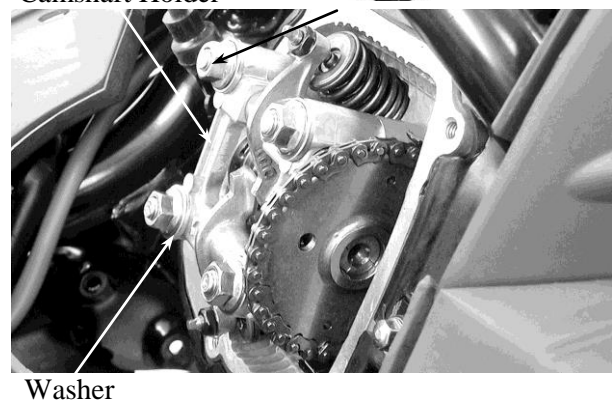

Adjust the valve clearance.

Turn the cam chain tensioner screw counter-clockwise to release it.

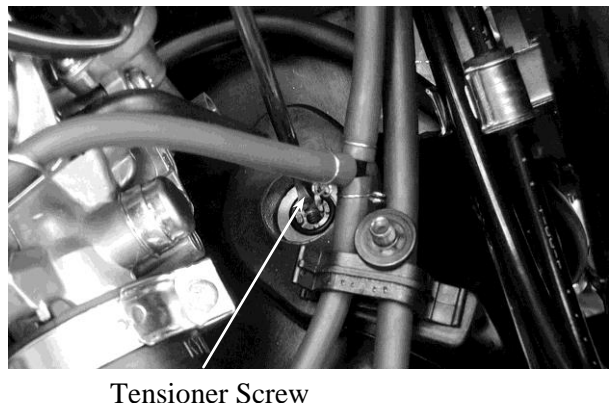

## 7. CYLINDER HEAD/VALVES

Apply engine oil to a new O-ring and install it.

Tighten the cam chain tensioner cap screw.

- \* Be sure to install the O-ring into the groove properly.

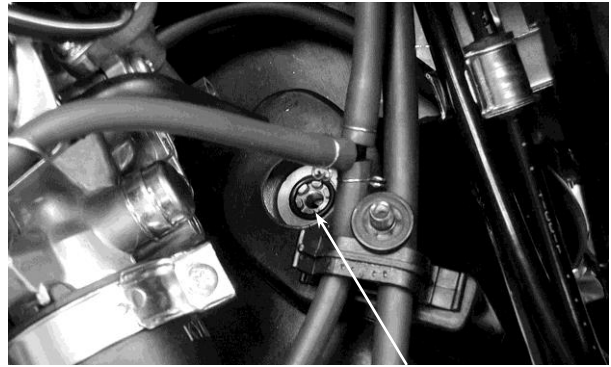

O-ring

Install a new cylinder head cover O-ring and install the cylinder head cover.  
Install and tighten the cylinder head cover bolts.

- \* Be sure to install the O-ring into the groove properly.

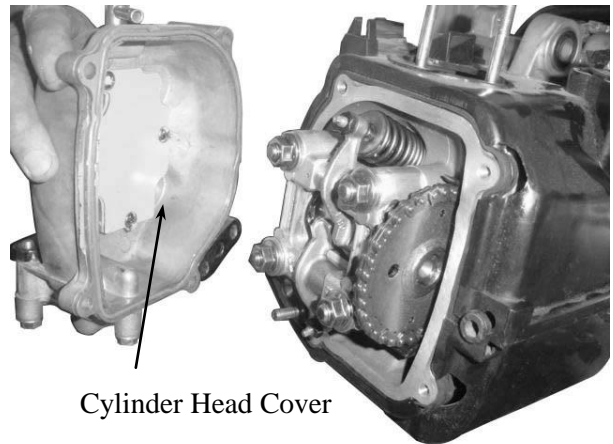

Cylinder Head Cover

# 8. CYLINDER/PISTON

Super 8 50

KL10CA(IT) E03

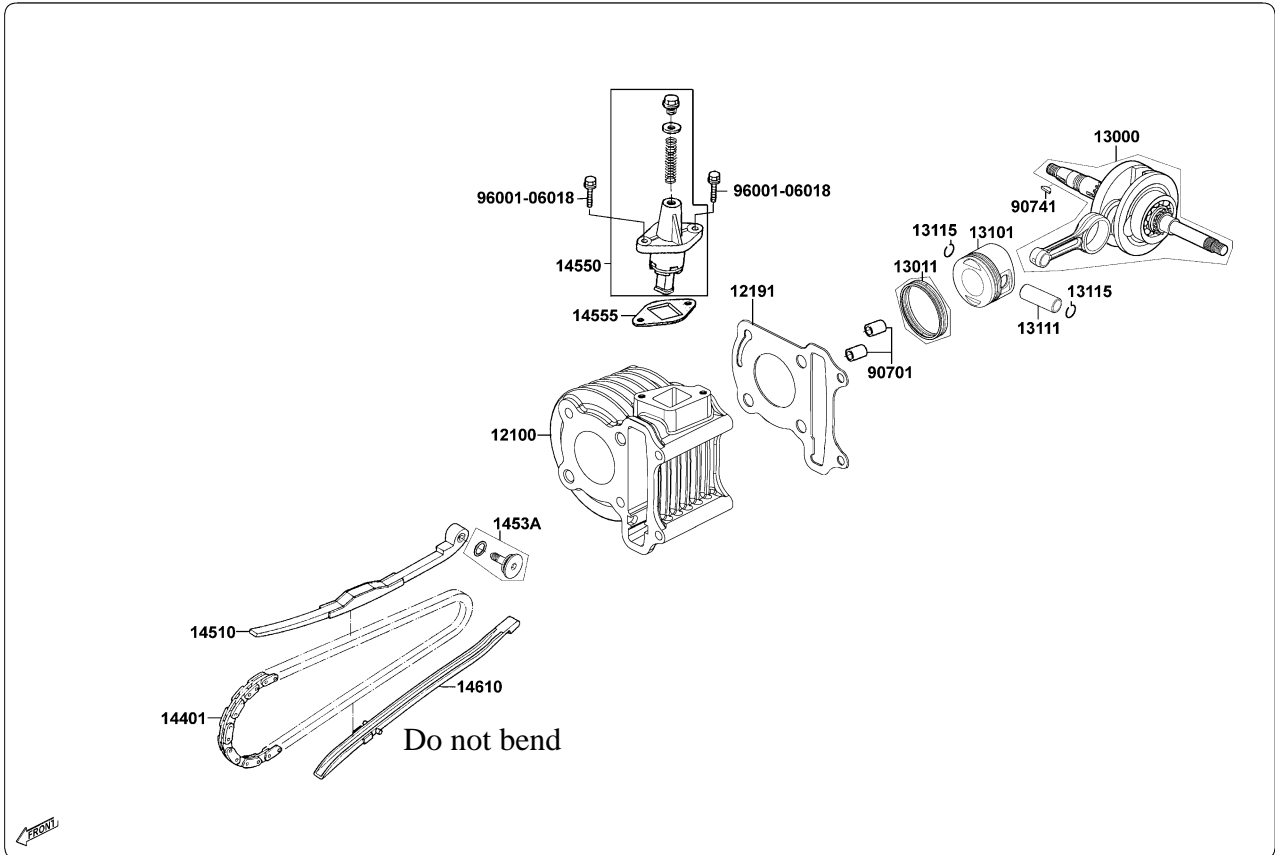

8

## 8. CYLINDER/PISTON

**Super 8 50**

SERVICE INFORMATION.....8-1	PISTON REMOVAL.....8-2
TROUBLESHOOTING.....8-1	PISTON INSTALLATION.....8-6
CYLINDER REMOVAL.....8-2	CYLINDER INSTALLATION.....8-6

### SERVICE INFORMATION

#### GENERAL INSTRUCTIONS

- The cylinder and piston can be serviced with the engine installed in the frame.
- After disassembly, clean the removed parts and dry them with compressed air before inspection.

#### SPECIFICATIONS

Item		Standard (mm)	Service Limit (mm)	
Cylinder	I.D.	39.00-39.01	39.1	
	Warpage	—	0.05	
	Cylindricity	—	0.05	
	True roundness	—	0.05	
Piston, piston ring	Ring-to-groove clearance	Top	0.015-0.050	0.09
		Second	0.015-0.050	0.09
	Ring end gap	Top	0.06-0.16	0.45
		Second	0.13-0.28	0.45
		Oil side rail	0.20-0.70	—
	Piston O.D.		38.855-38.875	38.8
	Piston O.D. measuring position		8mm from bottom of skirt	—
	Piston-to-cylinder clearance		0.010-0.040	0.1
Piston pin hole I.D.		13.002-13.008	13.04	
Piston pin O.D		12.994-13.000	12.96	
Piston-to-piston pin clearance		0.002-0.014	—	
Connecting rod small end I.D. bore		13.016-13.034	13.06	

### TROUBLESHOOTING

- When hard starting or poor performance at low speed occurs, check the crankcase breather for white smoke. If white smoke is found, it means that the piston rings are worn, stuck or broken.

#### Compression too low or uneven compression

- Worn, stuck or broken piston rings
- Worn or damaged cylinder and piston

#### Compression too high

- Excessive carbon build-up in combustion chamber or on piston head

#### Excessive smoke from exhaust muffler

- Worn or damaged piston rings
- Worn or damaged cylinder and piston

#### Abnormal noisy piston

- Worn cylinder, piston and piston rings
- Worn piston pin hole and piston pin



## 8. CYLINDER/PISTON

Super 8 50

### CYLINDER REMOVAL

Remove the cylinder head.  
Remove the cam chain guide.  
Remove the cylinder base bolts.  
Remove the cylinder.

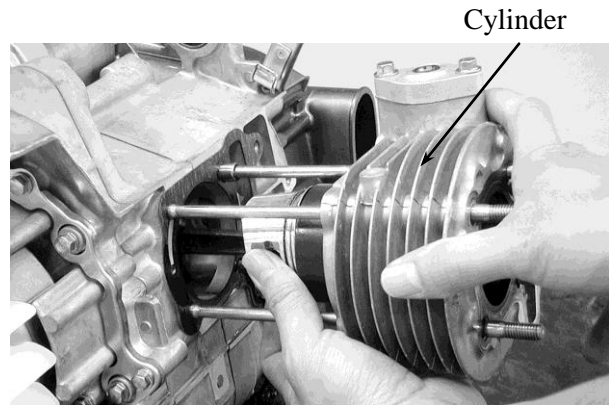

Remove the cylinder gasket and dowel pins.  
Clean any gasket material from the cylinder surface.

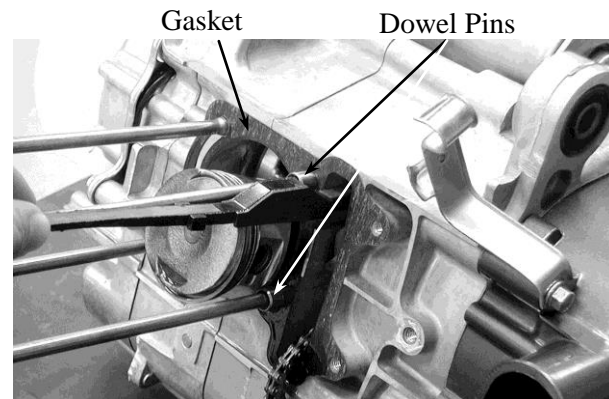

### PISTON REMOVAL

Remove the piston pin clip.

\* Place a clean shop towel in the crankcase to keep the piston pin clip from falling into the crankcase.

Press the piston pin out of the piston and remove the piston.



Piston Rings      Piston

## 8. CYLINDER/PISTON

Inspect the piston, piston pin and piston rings.  
Remove the piston rings.

- \* Take care not to damage or break the piston rings during removal.

Clean carbon deposits from the piston ring grooves.



Install the piston rings onto the piston and measure the piston ring-to-groove clearance.

**Service Limits:**

**Top:** 0.09mm replace if over

**2nd:** 0.09mm replace if over



Remove the piston rings and insert each piston ring into the cylinder bottom.

- \* Use the piston head to push each piston ring into the cylinder.

Measure the piston ring end gap.

**Service Limit:** 0.45mm replace if over

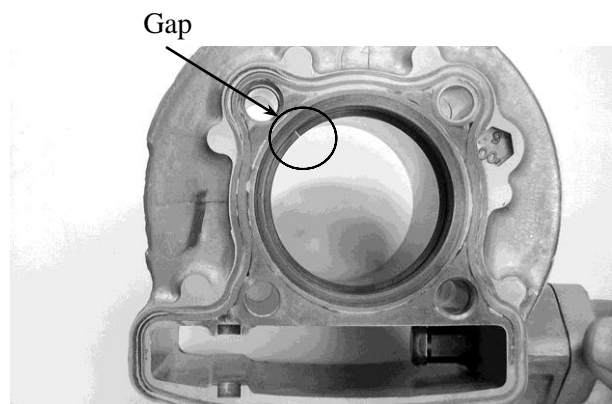

Measure the piston pin hole I.D.

**Service Limit:** 13.04mm replace if over

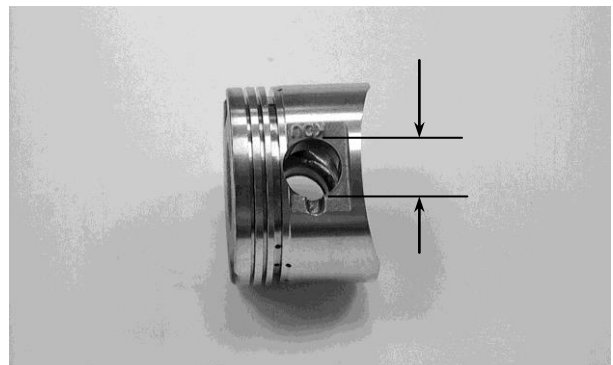

## 8. CYLINDER/PISTON

Measure the piston pin O.D.

**Service Limit:** 12.96mm replace if below

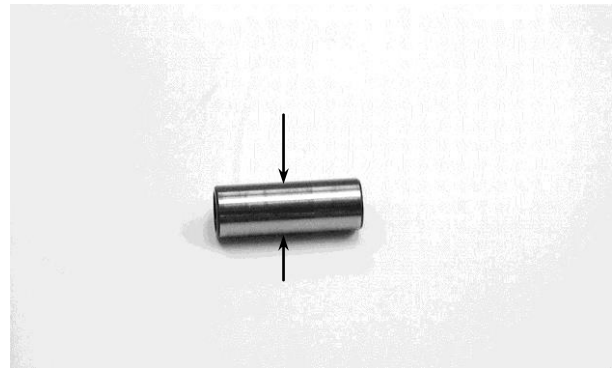

Measure the piston O.D.

\* Take measurement at 9mm from the bottom and 90° to the piston pin hole.

**Service Limit:** 38.9mm replace if below

Measure the piston-to-piston pin clearance.

**Service Limit:** 0.02mm replace if over

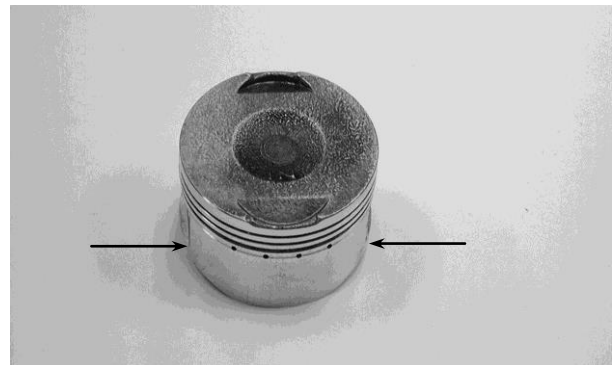

### CYLINDER INSPECTION

Inspect the cylinder bore for wear or damage. Measure the cylinder I.D. at three levels of top, middle and bottom at 90° to the piston pin (in both X and Y directions).

**Service Limit:** 39.10mm repair or replace if over

Measure the cylinder-to-piston clearance.

**Service Limit:** 0.1mm repair or replace if over



The true roundness is the difference between the values measured in X and Y directions. The cylindricity (difference between the values measured at the three levels) is subject to the maximum value calculated.

**Service Limits:**

**True Roundness:** 0.05mm repair or replace if over

**Cylindricity:** 0.05mm repair or replace if over

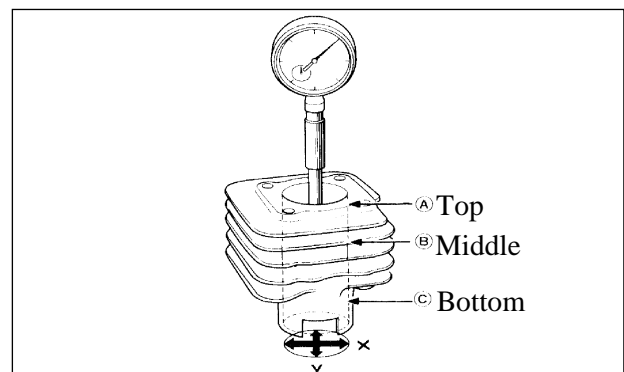

## 8. CYLINDER/PISTON

Inspect the top of the cylinder for warpage.

**Service Limit:**

0.05mm repair or replace if over

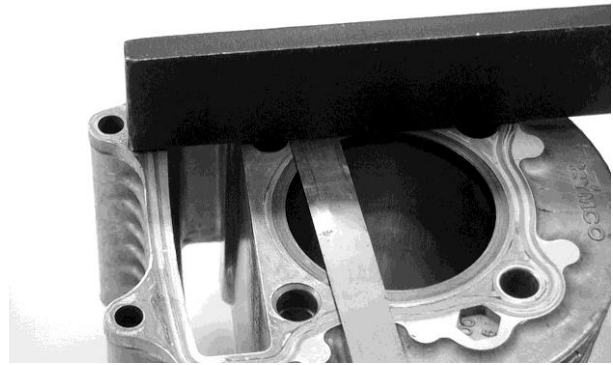

Measure the connecting rod small end I.D.

**Service Limit:** 13.06mm replace if over

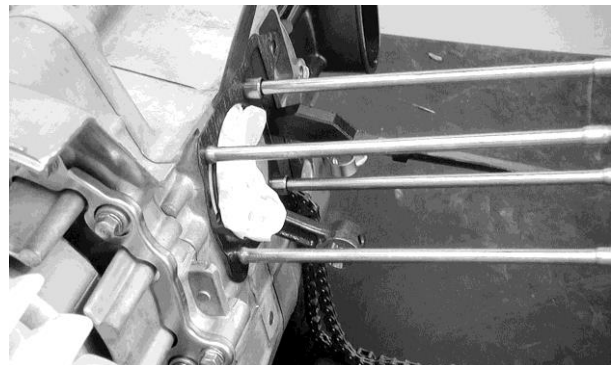

### PISTON RING INSTALLATION

Install the piston rings onto the piston.  
Apply engine oil to each piston ring.

- \*
- Be careful not to damage or break the piston and piston rings.
  - All rings should be installed with the markings facing up.
  - After installing the rings, they should rotate freely without sticking.

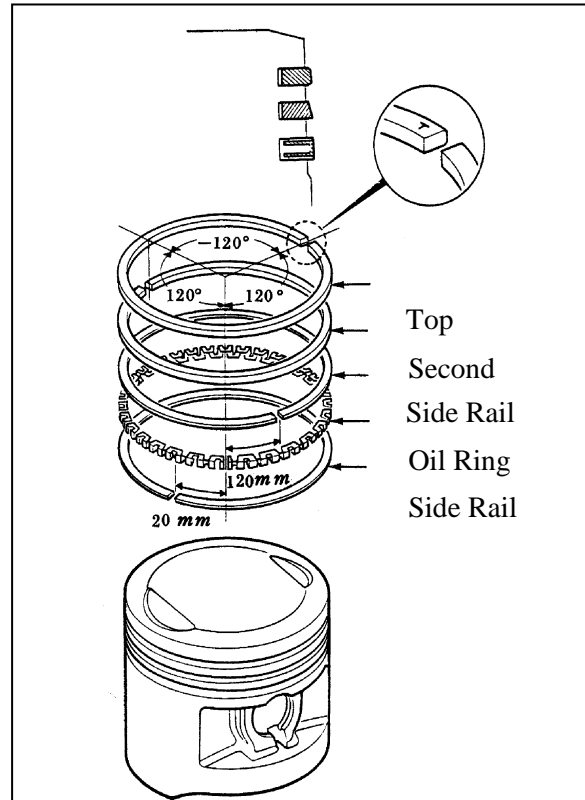

## 8. CYLINDER/PISTON

### PISTON INSTALLATION

Remove any gasket material from the crankcase surface.

- \* Be careful not to drop foreign matters into the crankcase.

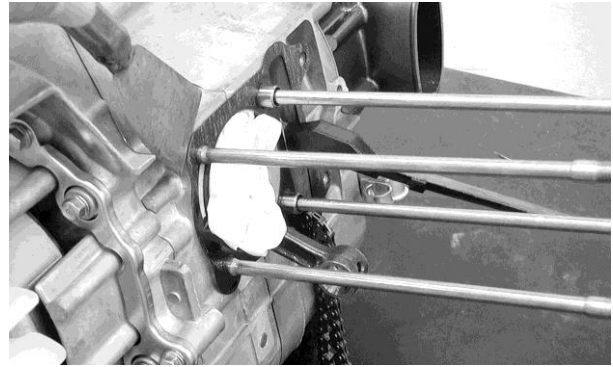

Install the piston, piston pin and a new piston pin clip.

- \*
  - Position the piston "IN" mark on the intake valve side.
  - Place a clean shop towel in the crankcase to keep the piston pin clip from falling into the crankcase.

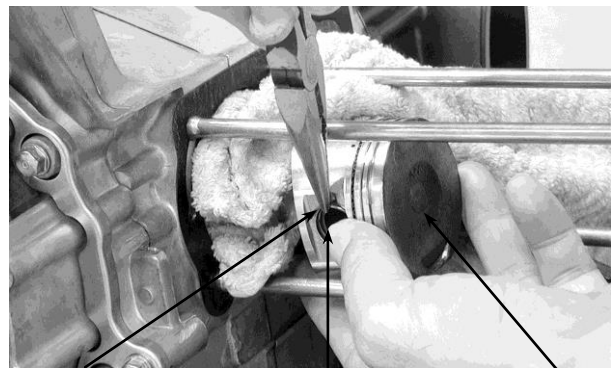

Piston Pin Clip

Piston Pin

Piston

### CYLINDER INSTALLATION

Install the dowel pins and a new cylinder gasket on the crankcase.



Gasket

Coat the cylinder bore, piston and piston rings with clean engine oil. Carefully lower the cylinder over the piston by compressing the piston rings.

- \*
  - Be careful not to damage or break the piston rings.
  - Stagger the ring end gaps at 120° to the piston pin.

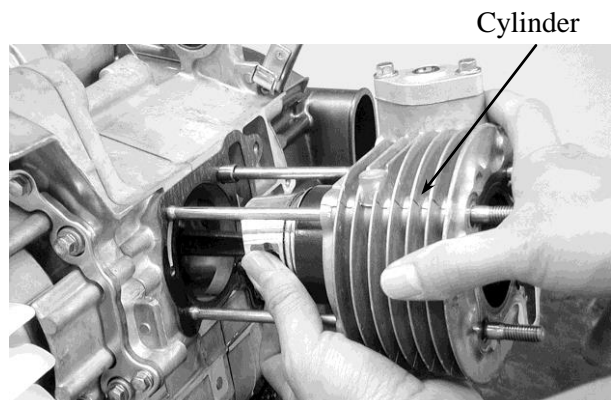

Cylinder

## 8. CYLINDER/PISTON

Loosely install the cylinder base bolts.

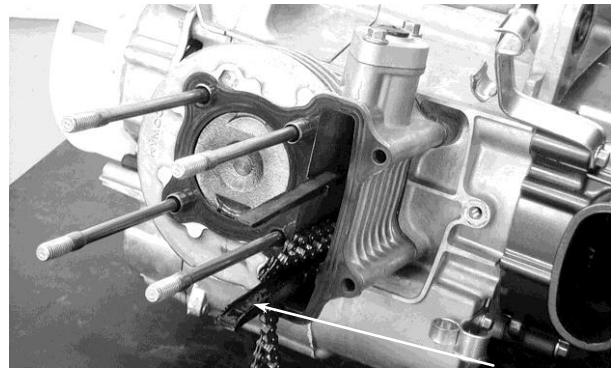

Cam Chain Guide

Install the cam chain guide.

- \* Insert the tab on the cam chain guide into the cylinder groove.

Install the cylinder head.  
Tighten the cylinder base bolts.



Cylinder Base Bolt

# 9. DRIVE AND DRIVEN PULLEYS

JAA(CN) E01

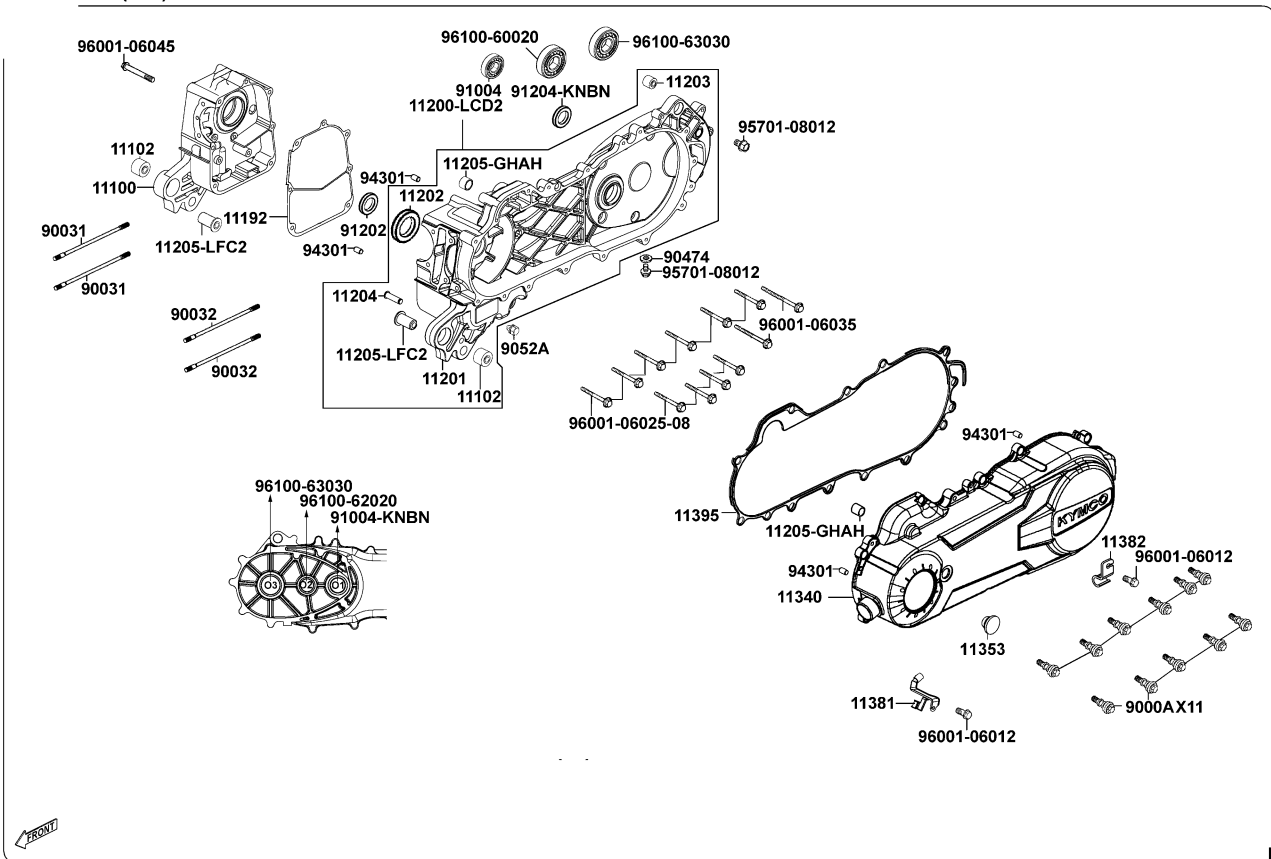

KP10AA(CN) E07

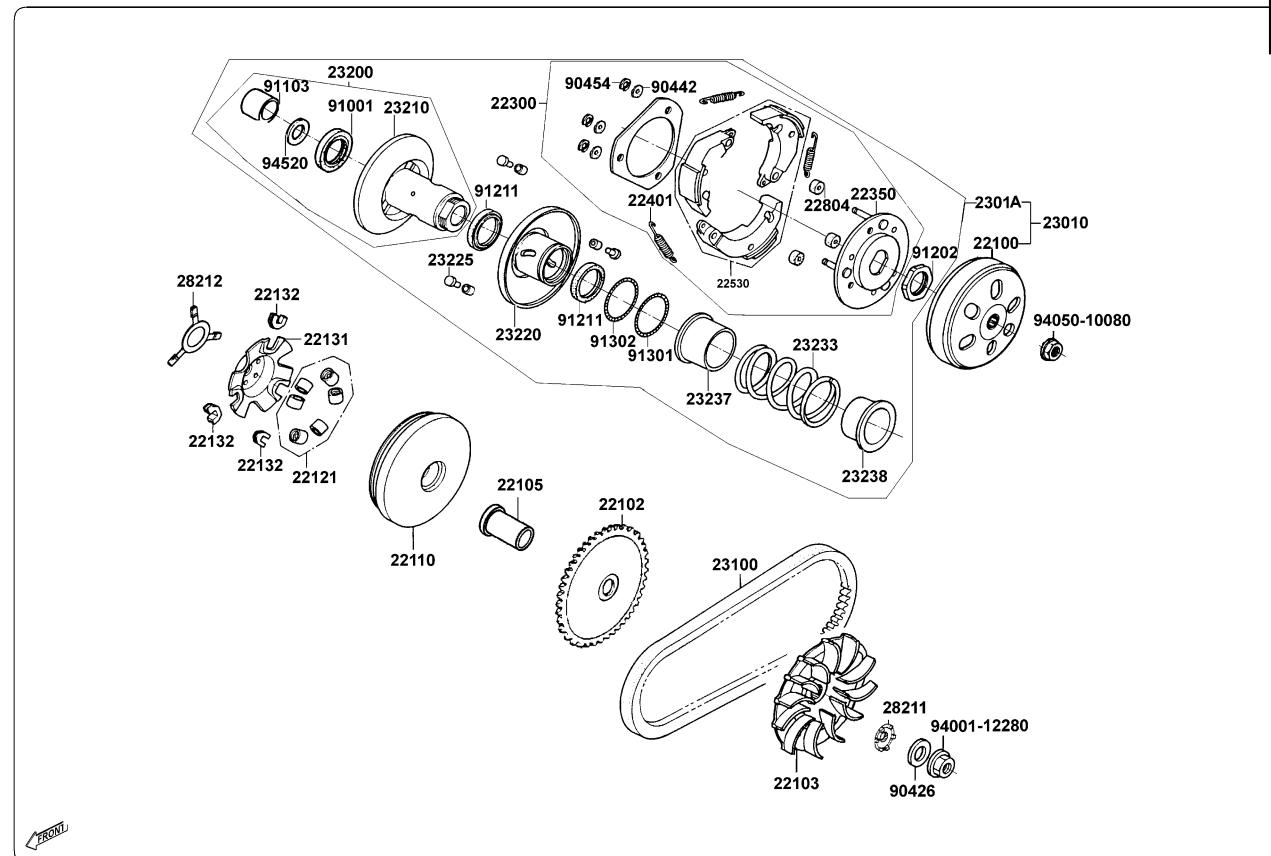

SERVICE INFORMATION .....9-1	DRIVE BELT ..... 9-5
TROUBLESHOOTING .....9-1	DRIVE PULLEY ..... 9-6
LEFT CRANKCASE COVER .....9-2	CLUTCH/DRIVEN PULLEY ..... 9-9
KICK STARTER .....9-2	

### SERVICE INFORMATION

#### GENERAL INSTRUCTIONS

- The drive pulley, clutch and driven pulley can be serviced with the engine installed.
- Avoid getting grease and oil on the drive belt and pulley faces. Remove any oil or grease from them to minimize the slipping of drive belt and drive pulley.

#### SPECIFICATIONS

Item	Standard (mm)	Service Limit (mm)
Movable drive face bushing I.D.	23.989~24.025	24.06
Drive face collar O.D.	23.960~23.974	23.94
Drive belt width	17.5	16.5
Clutch lining thickness	—	1.5
Clutch outer I.D.	107.0-107.2	107.5
Driven face spring free length	—	97
Driven face O.D.	33.965-33.485	33.94
Movable driven face I.D.	34.0-34.025	34.06
Weight roller O.D.	15.920~16.080	15.4

#### TORQUE VALUES

Drive face nut	5.5~6.5kgf-m
Clutch outer nut	3.5~4.5kgf-m
Clutch drive plate nut	5.0-6.0kg-m

#### SPECIAL TOOLS

Universal holder	Clutch spring compressor
------------------	--------------------------

#### TROUBLESHOOTING

##### Engine starts but motorcycle won't move

- Worn drive belt
- Broken ramp plate
- Worn or damaged clutch lining
- Broken driven face spring

##### Engine stalls or motorcycle creeps

- Broken clutch weight spring

##### Lack of power

- Worn drive belt
- Weak driven face spring
- Worn weight roller
- Fouled drive face



### LEFT CRANKCASE COVER

#### REMOVAL

Loosen the drive belt air tube band screw.

Air Tube Band



Remove the left crankcase cover bolts.  
Remove the seal rubber and dowel pins.

Left Crankcase Cover

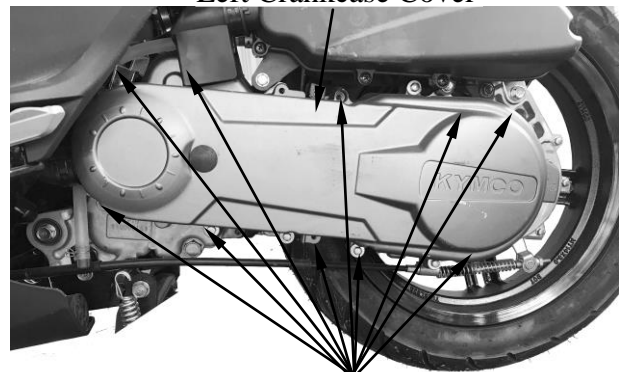

Bolts

Dowel Pins

#### INSTALLATION

Install the dowel pins and gasket.

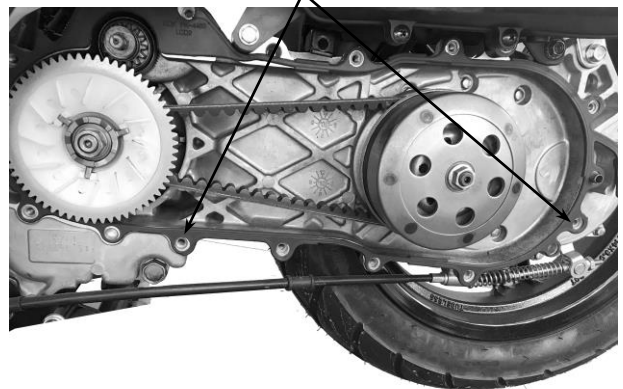

Install the left crankcase cover and tighten the left crankcase cover bolts.  
Install the cable clamp to the specified location and tighten the bolt.

Left Crankcase Cover

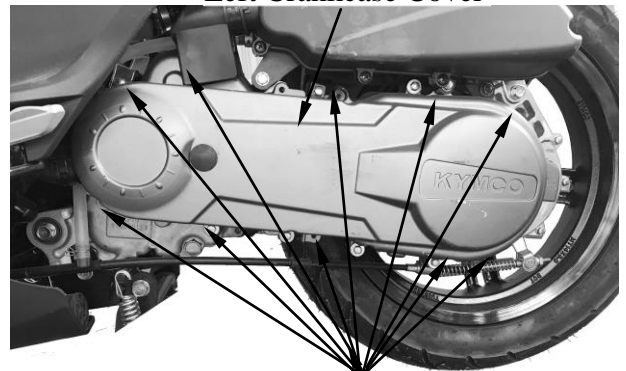

Bolts

Install the drive belt air tube and tighten the tube band screw.

### DRIVE PULLEY

#### REMOVAL

Remove the left crankcase cover.  
 Hold the drive pulley using an universal holder and remove the drive face nut and starting ratchet.  
 Remove the drive pulley face.

Special  
 Flywheel Holder

Hold the clutch outer with the universal holder and remove the clutch outer nut.  
 Remove the clutch/driven pulley and drive belt.

#### INSPECTION

Check the drive belt for cracks, separation or abnormal or excessive wear.  
 Measure the drive belt width.

**Service Limit:** 17.0mm replace if below

\* Use specified genuine parts for replace-ment.

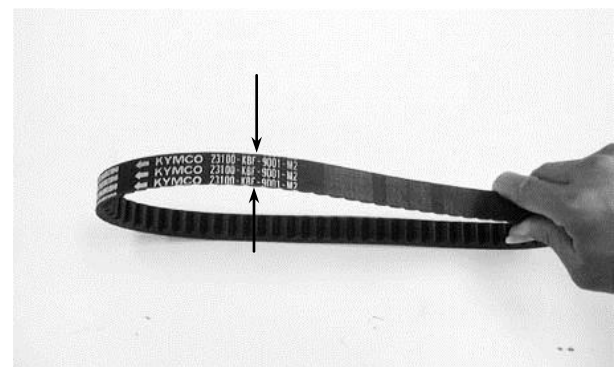
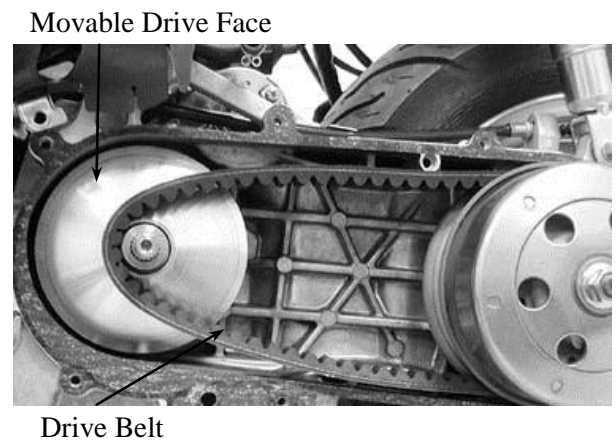
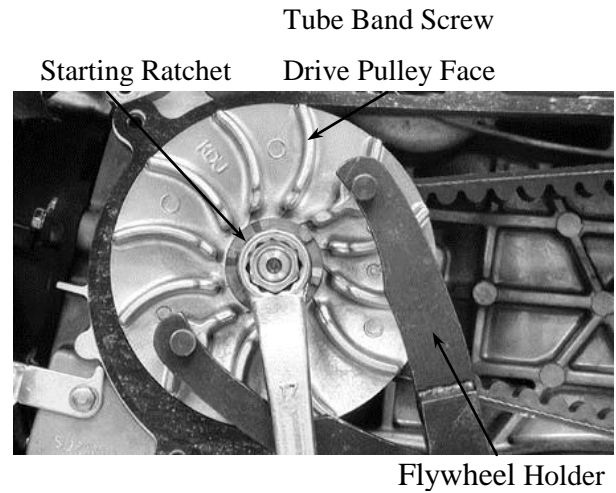

Intake Cover

Remove the movable drive face assembly.  
 Remove the drive pulley collar.

### DISASSEMBLY

Remove the ramp plate.

Drive Pulley Collar

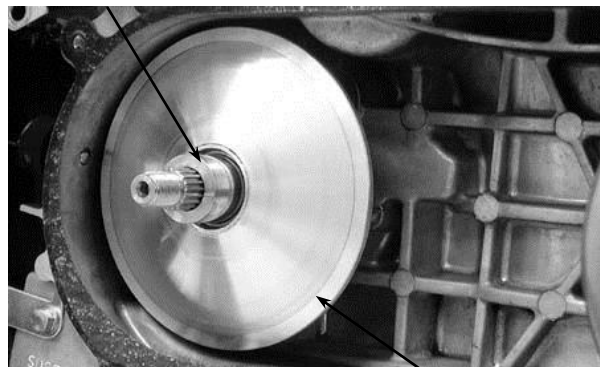

Movable Drive Face Assembly

Remove the weight rollers.

Ramp Plate

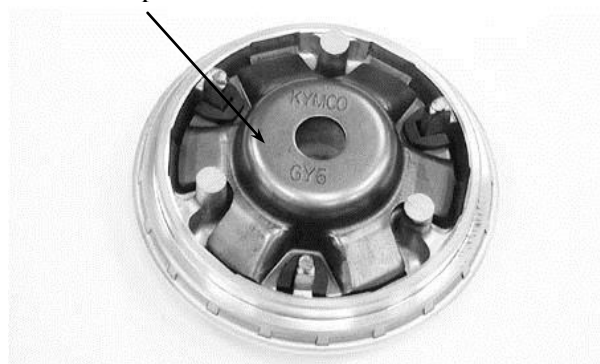

### INSPECTION

Check each weight roller for wear or damage.

Measure each weight roller O.D.

**Service Limit:** 15.4mm replace if below

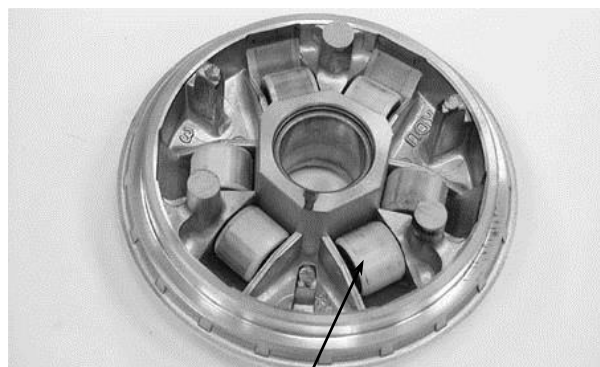

Weight Roller

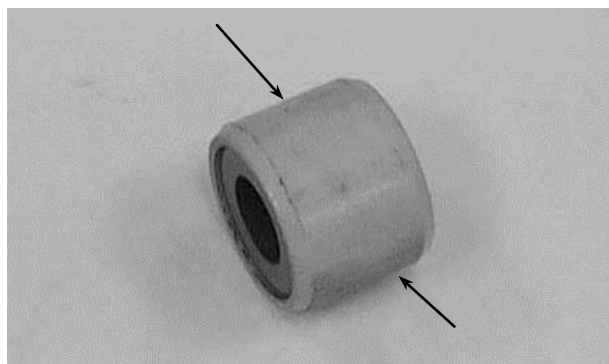

## 9. DRIVE AND DRIVEN PULLEYS

Measure the movable drive face bushing I.D.

**Service Limit:** 24.06mm replace if over



Check the drive pulley collar for wear or damage.  
Measure the O.D. of the drive pulley collar sliding surface.

**Service Limit:** 19.97mm replace if below

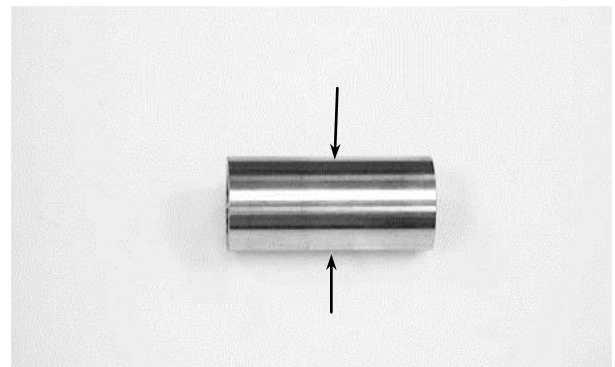

### ASSEMBLY

Install the weight rollers into the movable drive face.

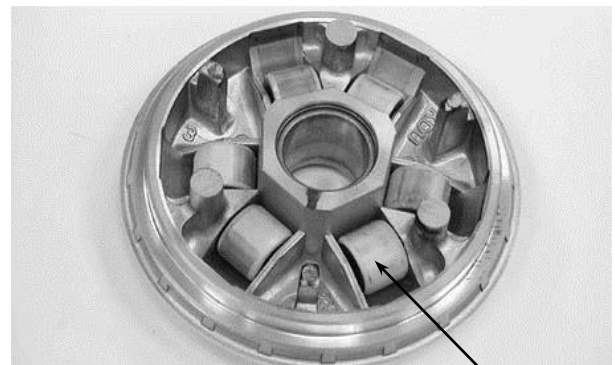

Weight Roller

Install the ramp plate.

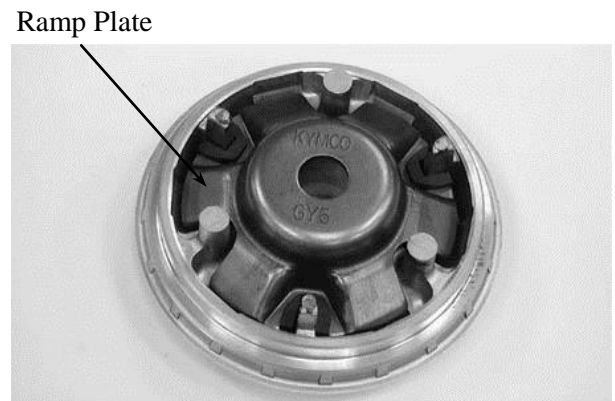

Ramp Plate

Insert the drive pulley collar into the movable drive face.

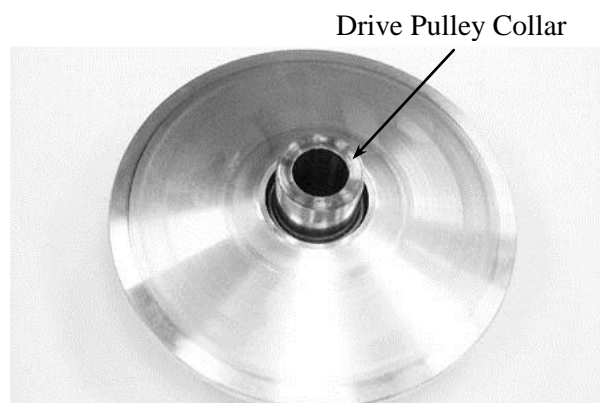

### INSTALLATION

Install the movable drive face onto the crankshaft.

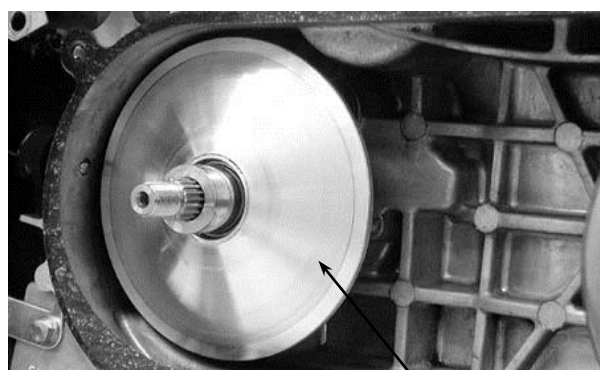

Lay the drive belt on the driven pulley.  
Set the drive belt on the drive pulley collar.

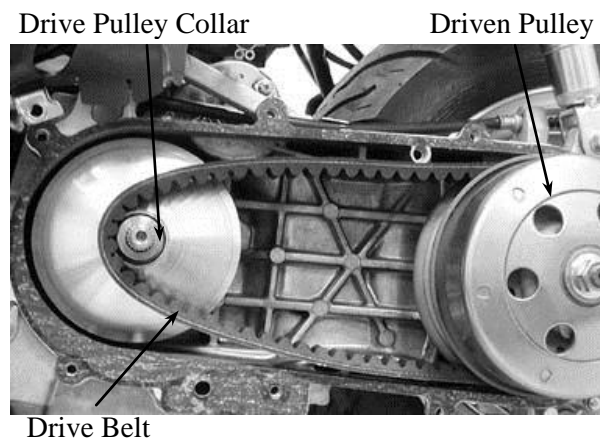

Install the drive pulley face, starting ratchet and drive face nut.

- \* When installing the drive pulley face, compress it to let the drive belt move downward to the lowest position so that the drive pulley can be tightened.
- Install the starting ratchet by aligning the starting ratchet teeth with the crankshaft teeth.

Drive Pulley Face

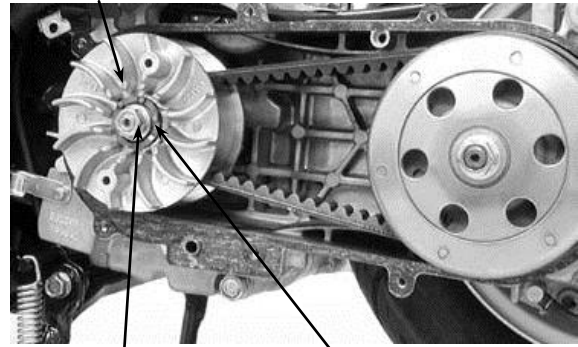

Drive Face Nut Starting Ratchet

Hold the drive pulley with the universal holder and tighten the drive face nut.

**Torque:** 5.5kg-m

Special

Flywheel Holder

- \* Do not get oil or grease on the drive belt or pulley faces.

Drive Pulley

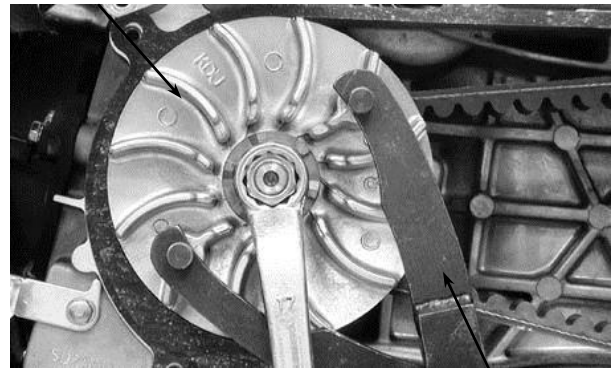

Flywheel Holder

### CLUTCH/DRIVEN PULLEY

Remove the left crankcase cover.  
Remove the drive pulley and drive belt.  
Hold the clutch outer with the universal holder and remove the clutch outer nut.

Special

Flywheel Holder

Clutch Outer

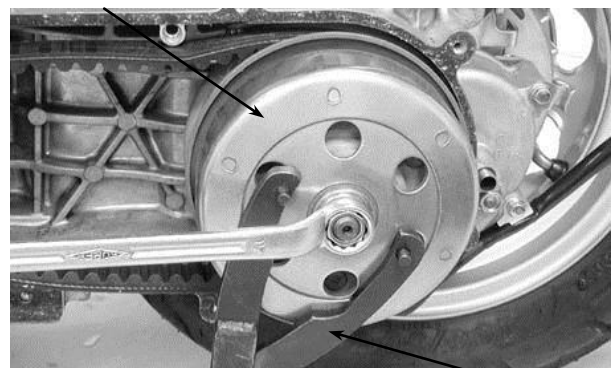

Flywheel Holder

### INSPECTION

Inspect the clutch outer for wear or damage.  
Measure the clutch outer I.D.

**Service Limit:** 125.5mm replace if over

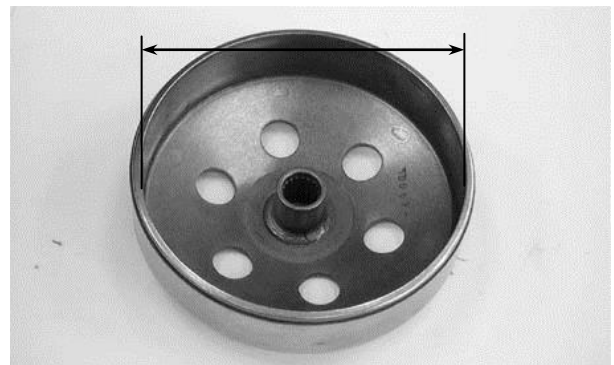

Check the clutch shoes for wear or damage.

## 9. DRIVE AND DRIVEN PULLEYS

Measure the clutch lining thickness.

**Service Limit:** 1.5mm replace if below

### CLUTCH/DRIVEN PULLEY DISASSEMBLY

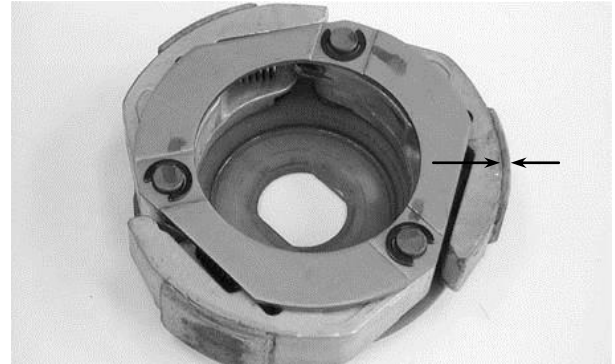

Clutch/Driven Pulley

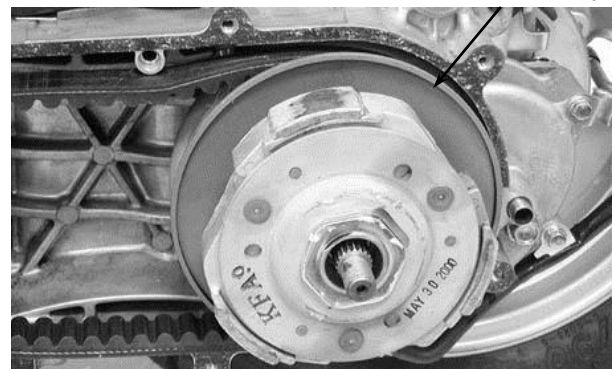

Hold the clutch/driven pulley assembly with the clutch spring compressor.

\* Be sure to use a clutch spring compressor to avoid spring damage.

Special

Clutch Spring Compressor

Clutch Spring Compressor

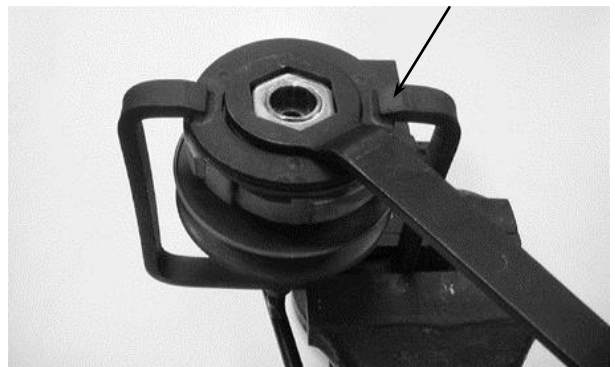

Set the clutch spring compressor in a vise and remove the clutch drive plate nut.

Loosen the clutch spring compressor and disassemble the clutch/driven pulley assembly.  
Remove the seal collar.



## 9. DRIVE AND DRIVEN PULLEYS

Pull out the guide roller pins and guide rollers. Remove the movable driven face from the driven face.

Remove the oil seal from the movable driven face.

Guide Roller      Guide Roller Pin

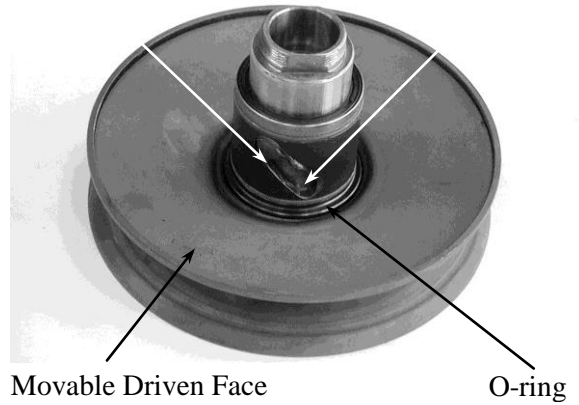

Oil Seal

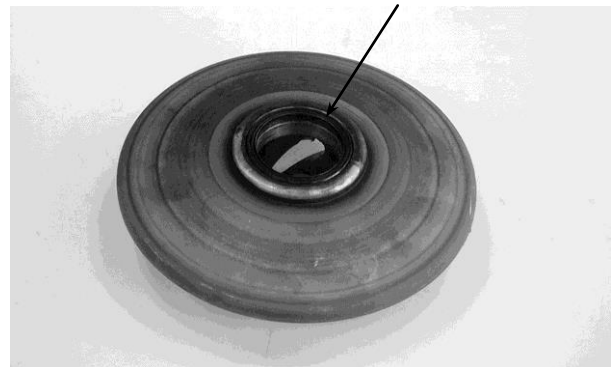

### INSPECTION

Measure the driven face spring free length.

**Service Limit:** 97mm replace if below

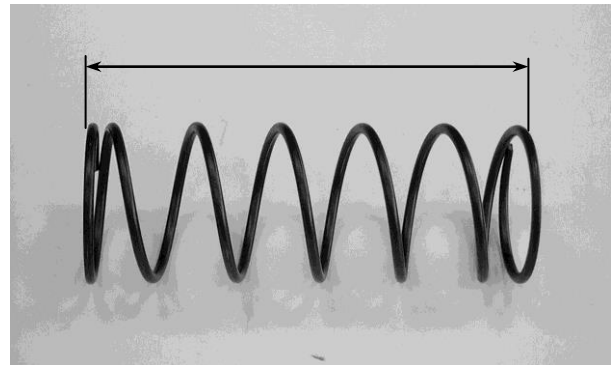

Check the driven face for wear or damage.  
Measure the driven face O.D.

**Service Limit:** 33.94mm replace if below

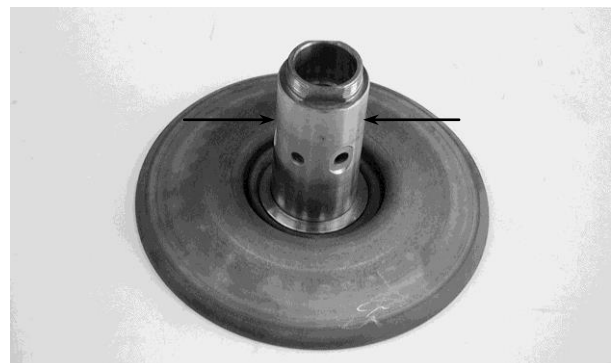



Check the movable driven face for wear or damage.

Measure the movable driven face I.D.

**Service Limit:** 34.06mm replace if over

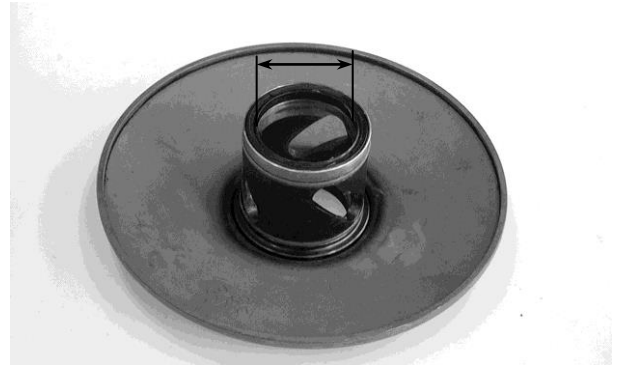

### DRIVEN PULLEY FACE BEARING REPLACEMENT

Drive the inner needle bearing out of the driven pulley face.

- \* Discard the removed bearing and replace with a new one.

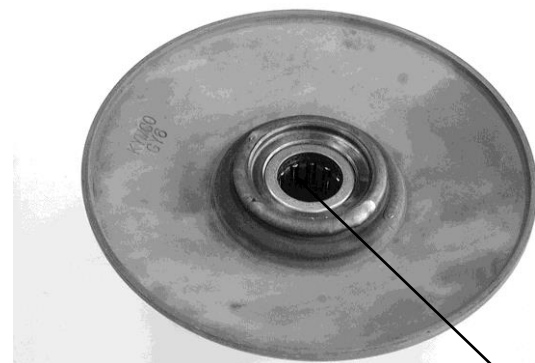

Inner Bearing

Remove the drive the outer bearing out of the driven face.

- \* Discard the removed bearing and replace with a new one.

Apply grease to the outer bearing.  
Drive a new outer bearing into the driven face with the sealed end facing up.

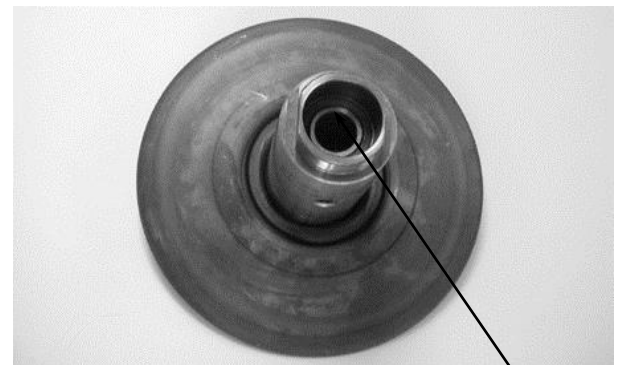

Outer Bearing

Apply grease to the driven face bore areas.

- \* Pack all bearing cavities with 5.0~5.6g grease.  
Specified grease: Heat resistance 230°C



Press a new needle bearing into the driven face.



### CLUTCH DISASSEMBLY

Remove the circlips and retainer plate to disassemble the clutch.

\* Keep grease off the clutch linings.

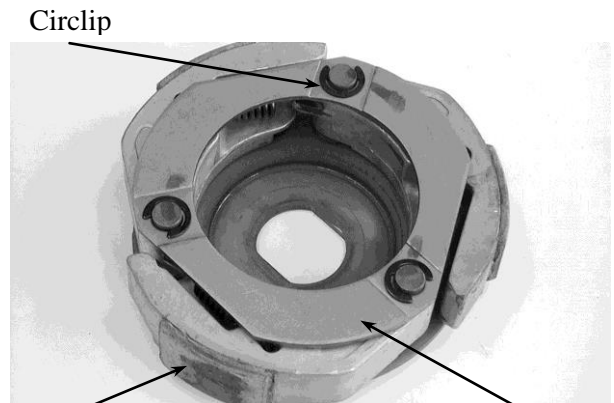

Clutch Lining                      Retainer Plate

### CLUTCH ASSEMBLY

Install the damper rubbers on the drive plate pins.  
 Install the clutch weights/shoes and clutch springs onto the drive plate.  
 Install the retainer plate and secure with the circlips.

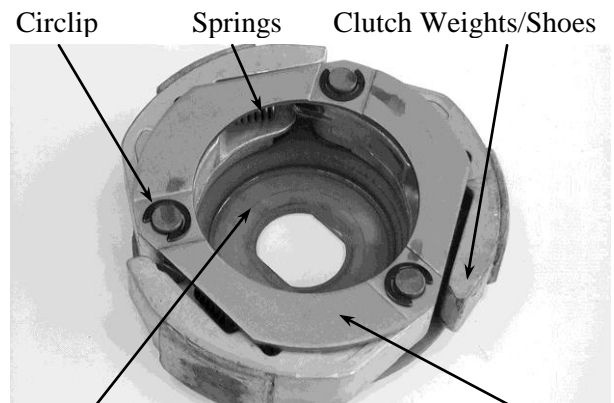

Drive Plate                      Retainer Plate

### CLUTCH/DRIVEN PULLEY ASSEMBLY

Clean the driven pulley faces and remove any grease from them.  
 Install the oil seal onto the moveable driven face.  
 Apply grease to the O-rings and install them onto the moveable driven face.

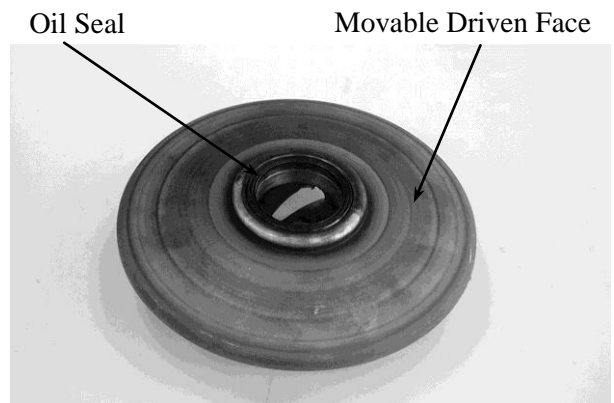

Install the movable driven face onto the driven face.  
 Apply grease to the guide rollers and guide roller pins and then install them into the holes of the driven face.  
 Install the seal collar.  
 Remove any excessive grease.

\* Be sure to clean the driven face off any grease.

Set the driven pulley assembly, driven face spring and clutch assembly onto the clutch spring compressor.

\* Align the flat surface of the driven face with the flat on the clutch drive plate.

Compress the clutch spring compressor and install the drive plate nut.  
 Set the clutch spring compressor in a vise and tighten the drive plate nut to the specified torque.

**Torque:** 5.5kg-m

\* Be sure to use a clutch spring compressor to avoid spring damage.

Special

Clutch Spring Compressor

### INSTALLATION

Install the clutch/driven pulley onto the drive shaft.

\* Keep grease off the drive shaft.

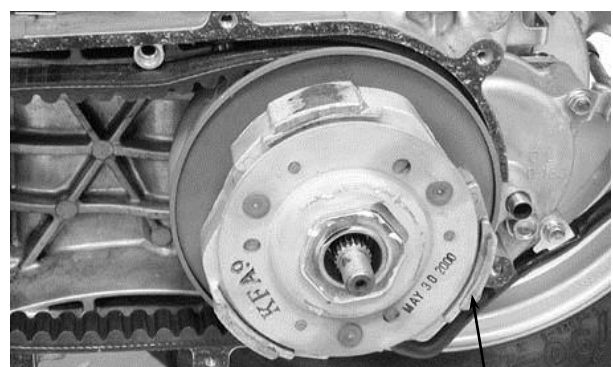
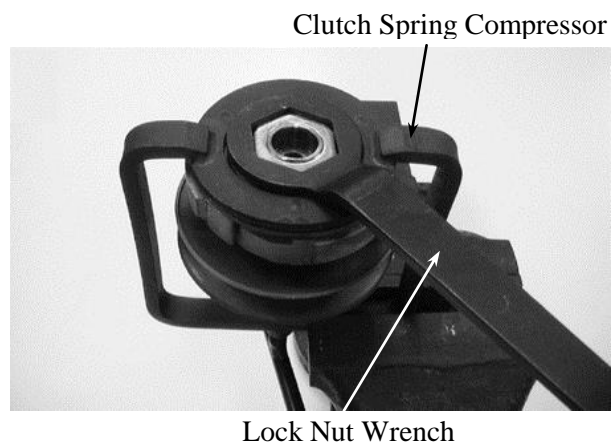
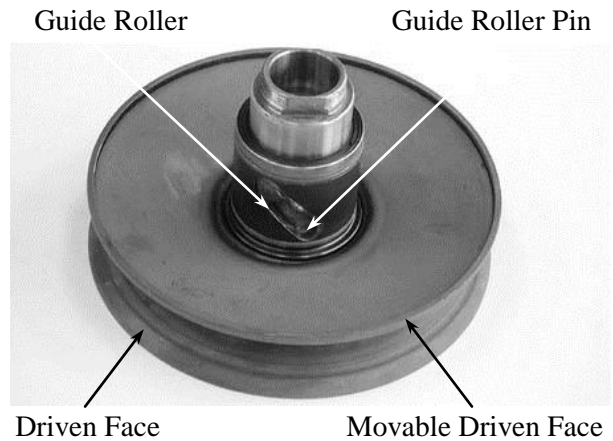

---

Clutch/Driven Pulley

Install the clutch outer.  
Hold the clutch outer with the universal  
holder.

Install and tighten the clutch outer nut.

**Torque:** 5.5kg-m

Special

Flywheel Holder

Install the drive belt.

Install the left crankcase cover.

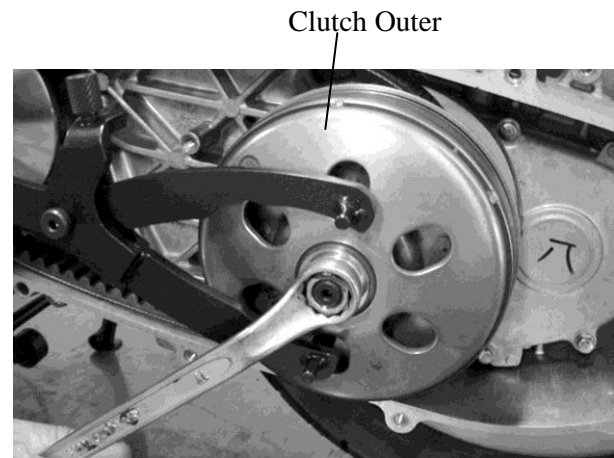

# 10. FINAL REDUCTION

KP10AA(CN) E10

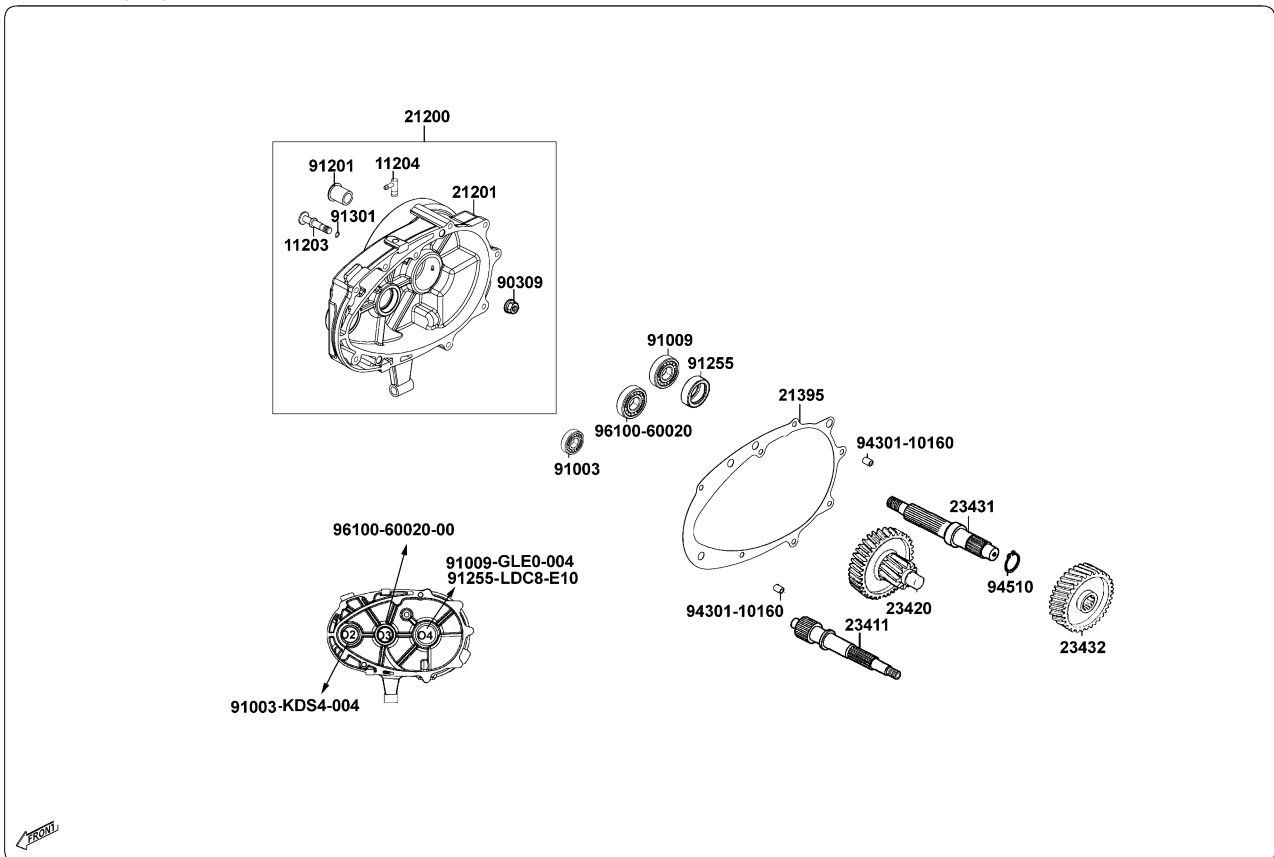

# 10. FINAL REDUCTION

---

SERVICE INFORMATION .....10-1	FINAL REDUCTION INSPECTION ..... 10-2
TROUBLESHOOTING.....10-1	BEARING REPLACEMENT ..... 10-3
FINAL REDUCTION DISASSEMBLY ....10-2	FINAL REDUCTION ASSEMBLY ..... 10-4

## SERVICE INFORMATION

### SPECIFICATIONS

Specified Oil: GEAR OIL SAE 90#

Oil Capacity:       At disassembly : 0.21 liter  
                          At change         : 0.18 liter

### SPECIAL TOOLS

Bearing puller, 10,12,15,18mm

## TROUBLESHOOTING

### Engine starts but motorcycle won't move

- Damaged transmission
- Seized or burnt transmission
- Faulty drive belt
- Faulty clutch

### Abnormal noise

- Worn, seized or chipped gears
- Worn bearing

### Oil leaks

- Oil level too high
- Worn or damaged oil seal

# 10. FINAL REDUCTION

## FINAL REDUCTION DISASSEMBLY

- Remove the rear brake cable. (⇒13-3)
- Remove the rear wheel. (⇒13-2)
- Remove the left crankcase cover. (⇒9-2)
- Remove the clutch/driven pulley. (⇒9-10)
- Drain the transmission gear oil into a clean container.
- Remove the transmission case cover attaching bolts.
- Remove the transmission case cover.
- Remove the gasket and dowel pins.

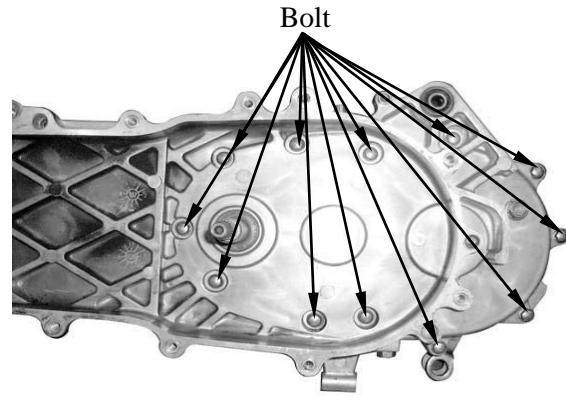

Remove the final gear and countershaft.

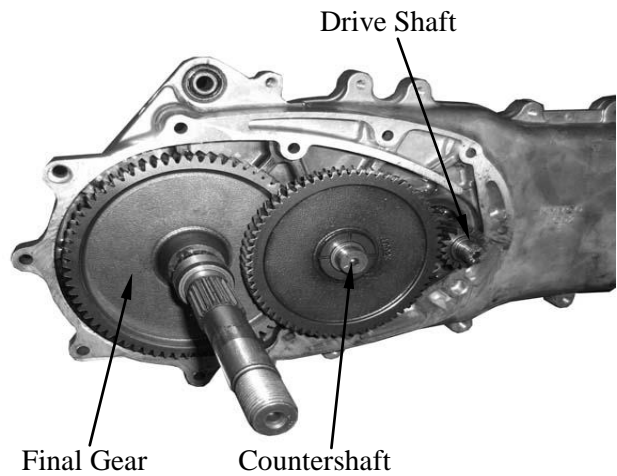

## FINAL REDUCTION INSPECTION

Inspect the countershaft and gear for wear or damage.

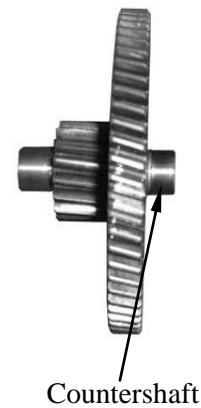

Inspect the final gear and final shaft for wear, damage or seizure.

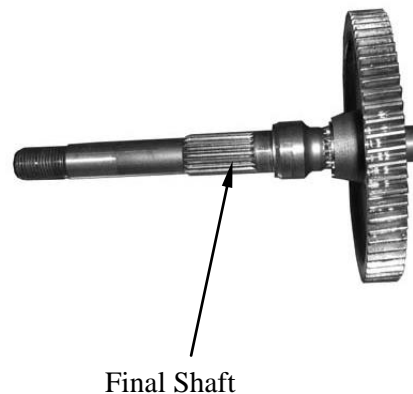

# 10. FINAL REDUCTION

Check the left crankcase bearings for excessive play and inspect the oil seal for wear or damage.

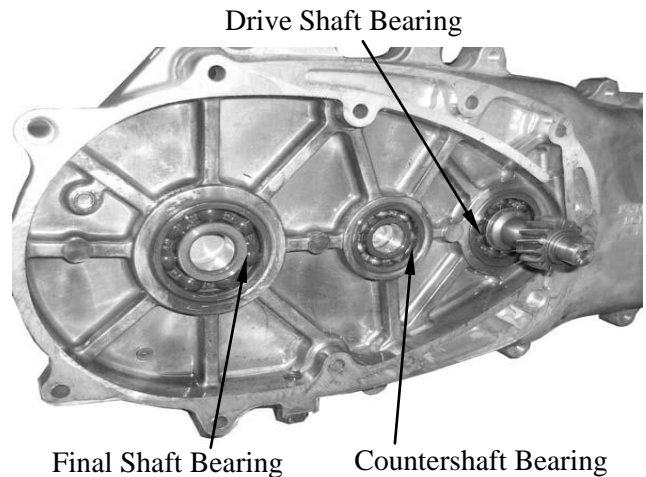

Inspect the drive shaft and gear for wear or damage.  
Check the transmission case cover bearings for excessive play and inspect the final shaft bearing oil seal for wear or damage.

\* Do not remove the transmission case cover except for necessary part replacement. When replacing the drive shaft, also replace the bearing and

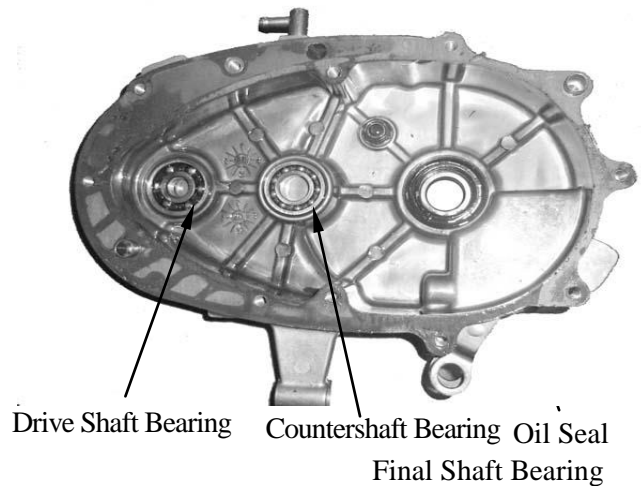

## BEARING REPLACEMENT (TRANSMISSION CASE COVER)

Remove the transmission case cover bearings using a bearing puller.  
Remove the final shaft oil seal.

**Special**

Bearing Puller

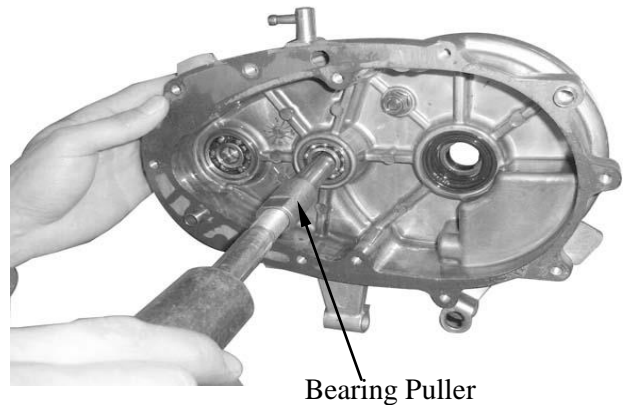

Drive new bearings into the transmission case cover.

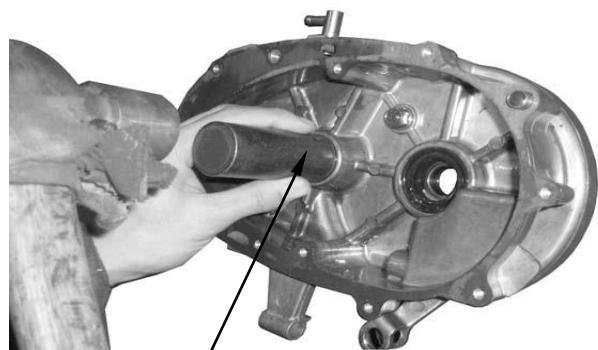



# 10. FINAL REDUCTION

Outer Driver, 32x35mm

## BEARING REPLACEMENT (LEFT CRANKCASE)

Remove the drive shaft.  
Remove the drive shaft oil seal.  
Remove the left crankcase bearings using a bearing puller.

**Special**

Bearing Puller

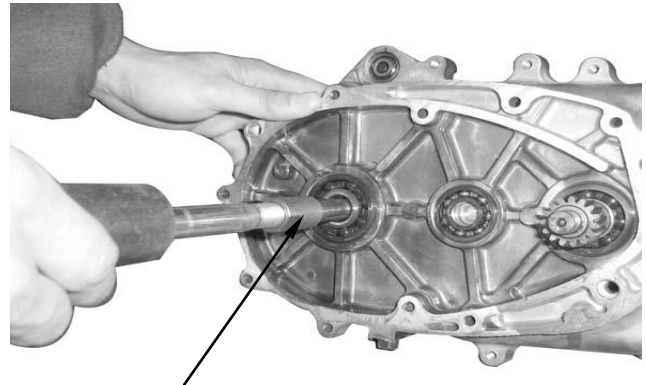

Bearing Puller, 12mm

Drive new bearings into the left crankcase.  
Install a new drive shaft oil seal.

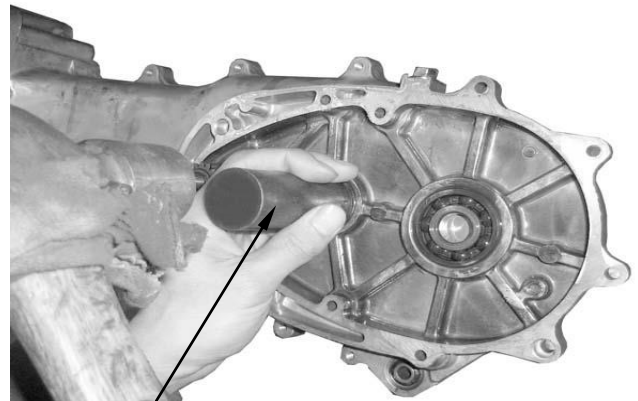

Pilot

## FINAL REDUCTION ASSEMBLY

Install the drive shaft into the left crankcase.

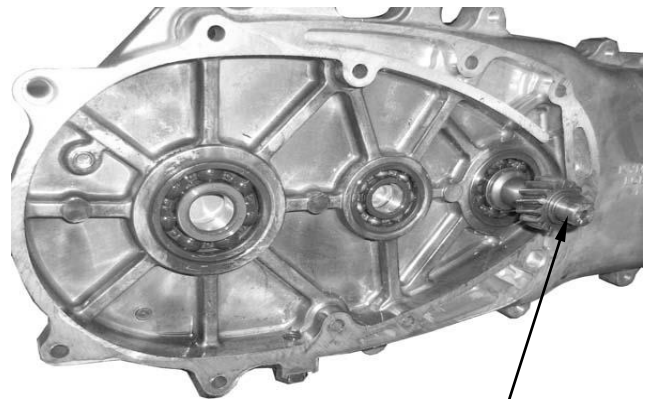

Drive Shaft

Install the final gear and final shaft into the left crankcase.

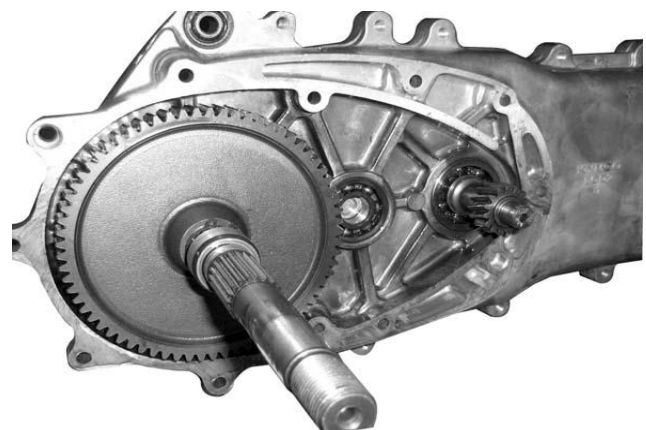

# 10. FINAL REDUCTION

Install the countershaft and gear into the left crankcase.  
Install the dowel pins and a new gasket.

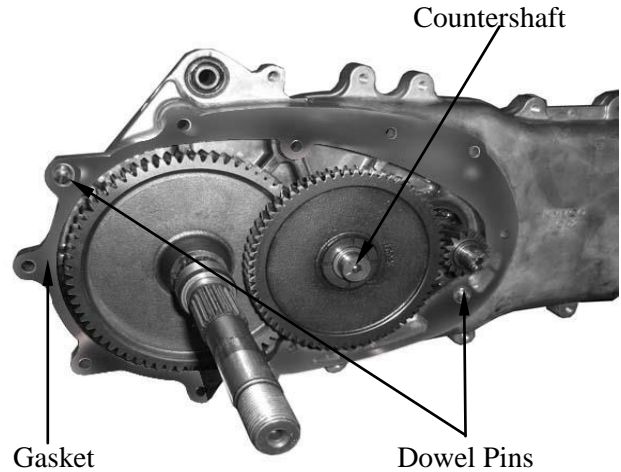

Install the transmission case cover.

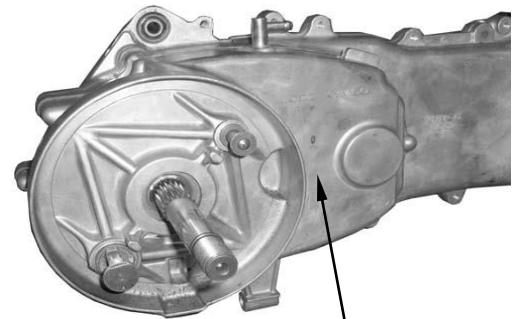

Transmission Case Cover Bolts

Install and tighten the transmission case cover bolts.  
Install the clutch/driven pulley. (⇒9-13)

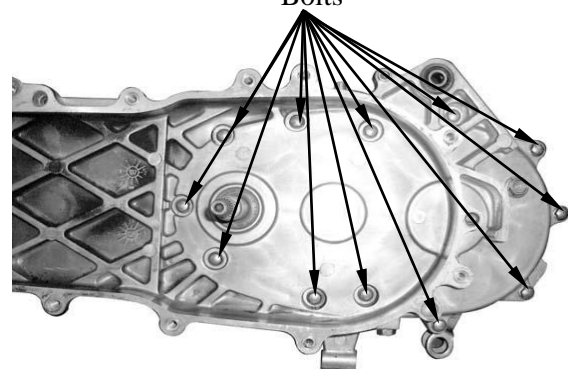

After installation, fill the transmission case with the specified oil. (⇒3-7)

- \***
- Place the motorcycle on its main stand on level ground.
  - Check the oil sealing washer for wear or damage.

**Specified Gear Oil:** SAE90#

**Oil Capacity:**

- At disassembly : 0.2 liter
- At change : 0.18 liter

Install and tighten the oil check bolt.

**Torque:** 0.8~1.2kgf-m

Start the engine and check for oil leaks.  
Check the oil level from the oil check bolt hole and add the specified oil to the proper level if the oil level is low.

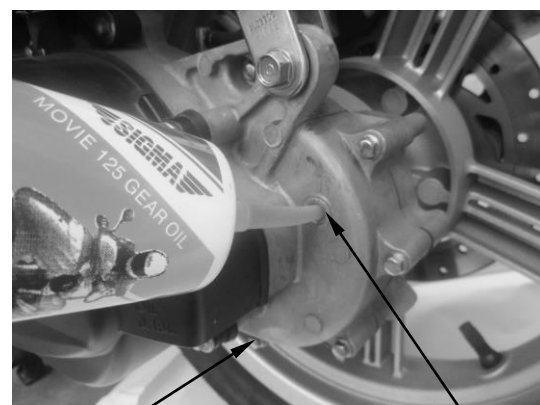

Drain Bolt Oil Check Bolt Hole/Oil Filler

# 11. CRANKCASE/CRANKSHAFT

KL10CA(IT) E03

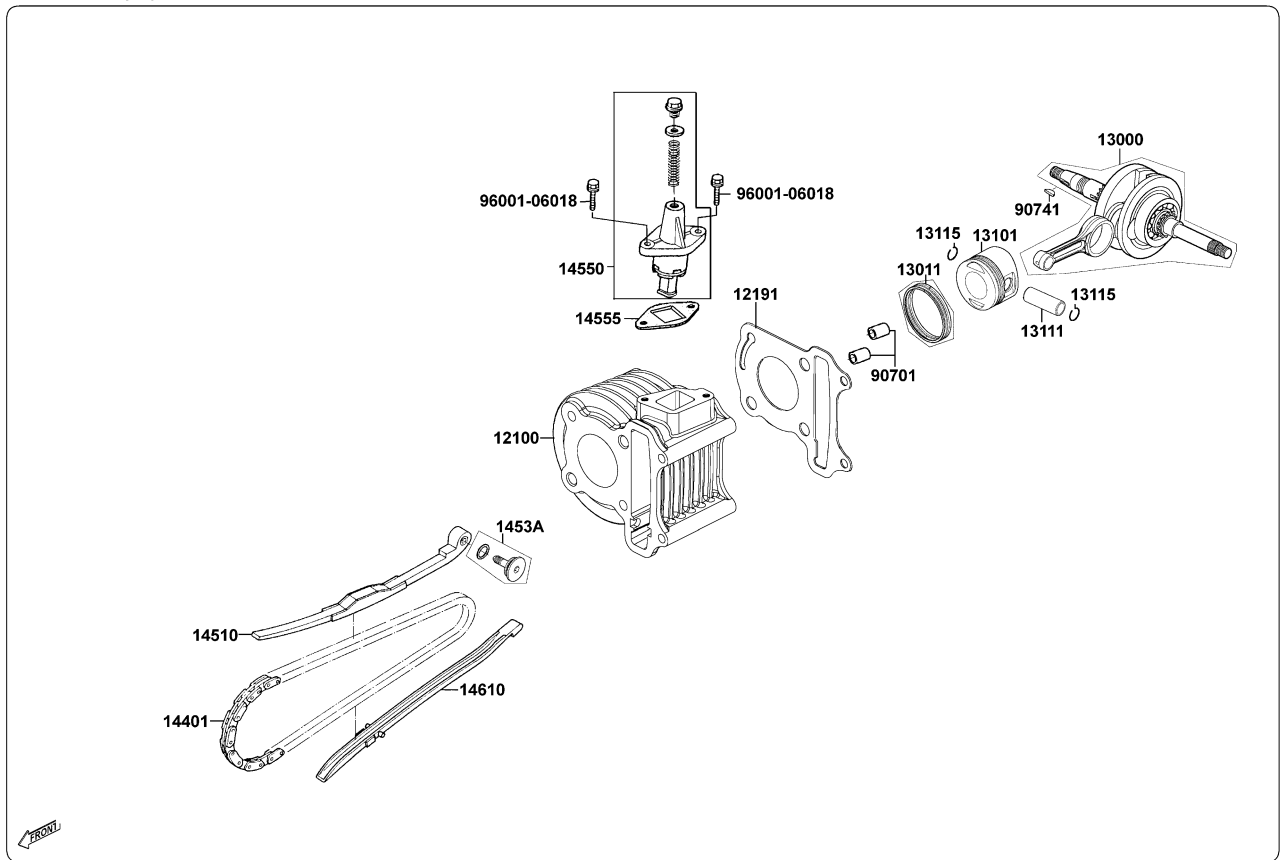

# 11. CRANKCASE/CRANKSHAFT

SERVICE INFORMATION.....	11-1	CRANKSHAFT.....	11-3
TROUBLESHOOTING.....	11-1	CRANKCASE ASSEMBLY.....	11-4
CRANKCASE SEPARATION .....	11-2		

## SERVICE INFORMATION

### GENERAL INSTRUCTIONS

- This section covers crankcase separation to service the crankshaft. The engine must be removed for this operation.
- The following parts must be removed before separating the crankcase.
  - Cylinder head (⇒Section 7)
  - Cylinder/piston (⇒Section 8)
  - Drive and driven pulleys (⇒Section 9)
  - A.C. generator (⇒Section 14)
  - Carburetor/air cleaner (⇒Section 5)
  - Rear wheel/rear shock absorber (⇒Section 13)
  - Starter motor (⇒Section 16)
  - Oil pump (⇒Section 4)

### SPECIFICATIONS

	Item	Standard (mm)	Service Limit (mm)
Crankshaft	Connecting rod big end side clearance	0.10~0.35	0.55
	Connecting rod big end radial clearance	0-0.008	0.05
	Runout	—	0.10

### TORQUE VALUES

Crankcase bolt	0.8~1.2kgf-m
Cam chain tensioner slipper bolt	0.8~1.2kgf-m

## TROUBLESHOOTING

### Excessive engine noise

- Excessive bearing play
- Excessive crankpin bearing play

# 11. CRANKCASE/CRANKSHAFT

## CRANKCASE SEPARATION

Remove the two crankcase attaching bolts.  
Separate the left and right crankcase halves.

\* Do not damage the crankcase gasket surface.

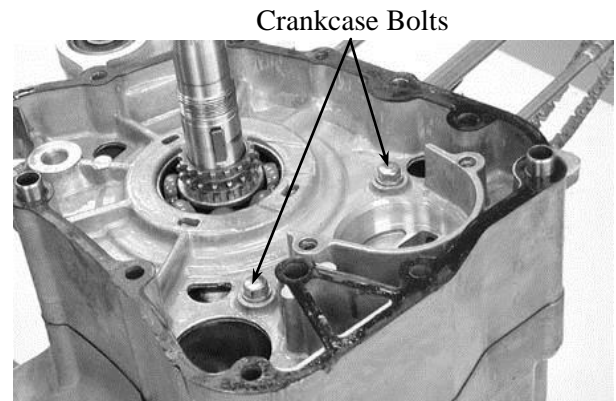

Remove the gasket and dowel pins.

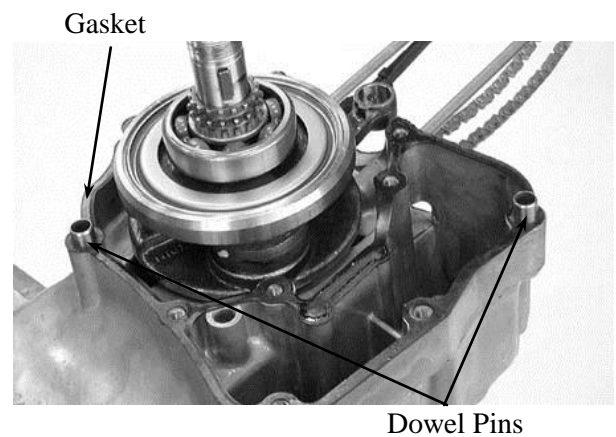

Remove the crankshaft and cam chain from the left crankcase.

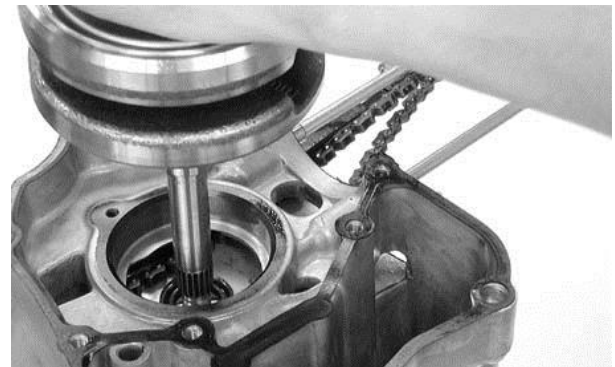

Clean off all gasket material from the crankcase mating surfaces.

\* Avoid damaging the crankcase mating surfaces.

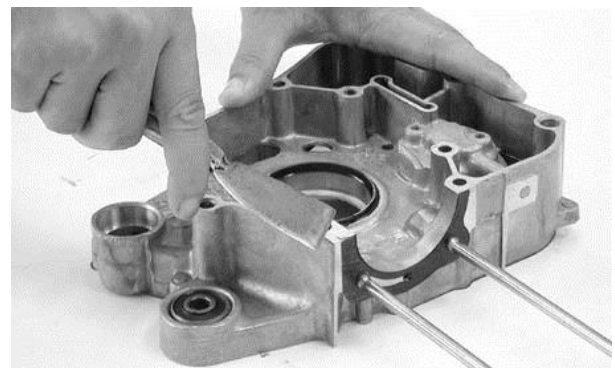

## 11. CRANKCASE/CRANKSHAFT

Remove the oil seal from the right crankcase.  
Check the oil seal lip for wear or deterioration.  
The installation sequence is the reverse of removal.

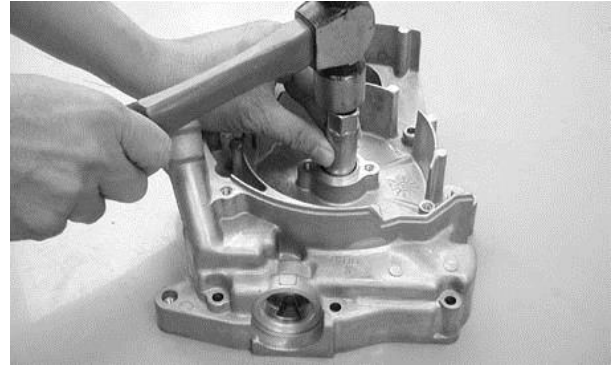

### CRANKSHAFT INSPECTION

Measure the connecting rod big end side clearance.

**Service Limit:** 0.55mm replace if over

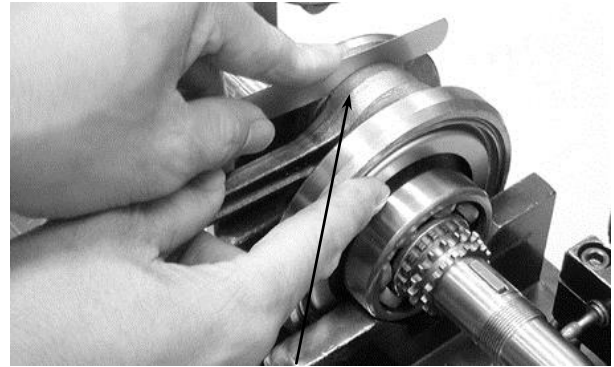

Connecting Rod Big End

Measure the connecting rod big end radial clearance at two points at right angles to the shaft.

**Service Limit:** 0.05mm replace if over

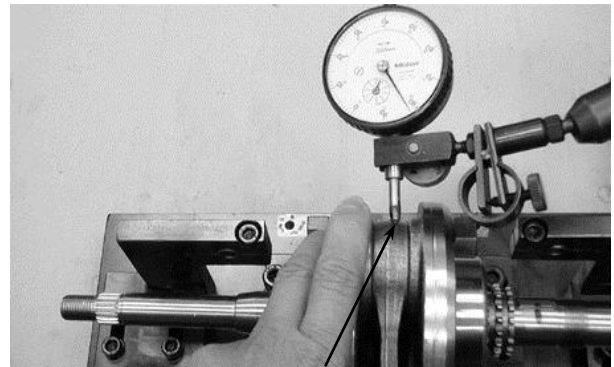

Measuring Location

Measure the crankshaft runout.

**Service Limit:** 0.10mm replace if over

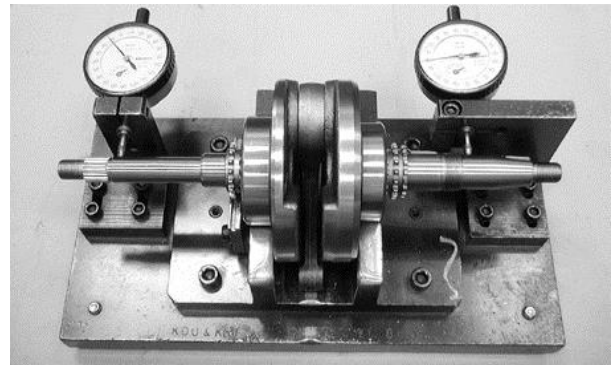

# 11. CRANKCASE/CRANKSHAFT

Turn the crankshaft bearings and check for excessive play.  
If they do not turn smoothly, quietly or if they fit loosely in the crankshaft, replace the crankshaft as a set.

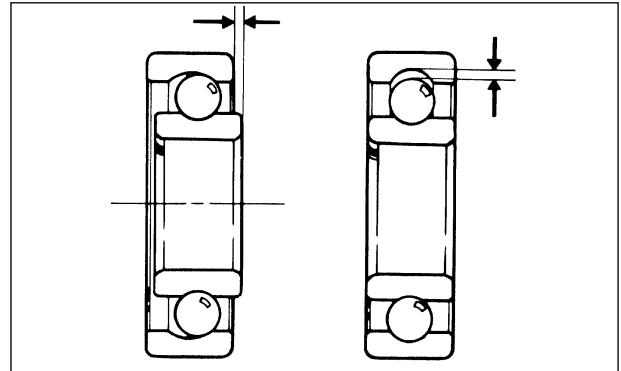

## CRANKCASE ASSEMBLY

Install the cam chain into the left crankcase.



Cam Chain

Install the crankshaft into the left crankcase.

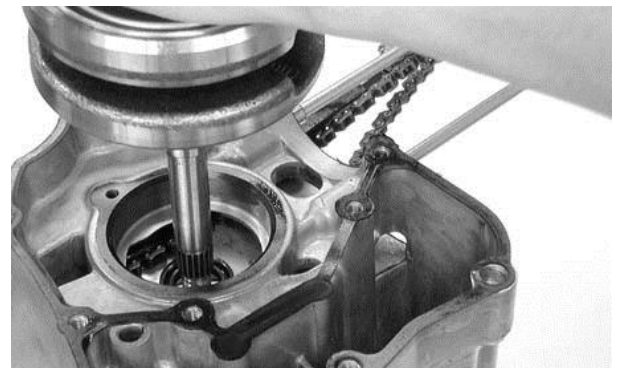

Install the dowel pins and a new gasket onto the left crankcase.

\* Place the right crankcase over the crankshaft and onto the left crankcase.

Gasket

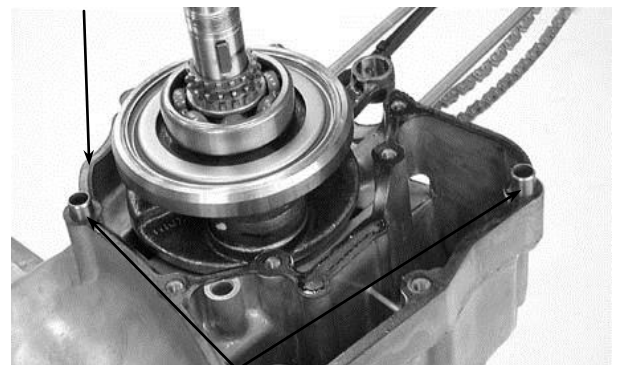

Dowel Pins

## 11. CRANKCASE/CRANKSHAFT

---

Tighten the two crankcase attaching bolts.

**Torque:** 0.8~1.2kg-m

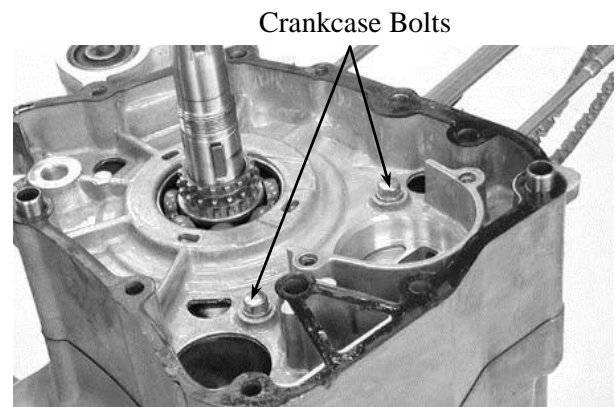



# 12. FRONT WHEEL/FRONT BRAKE/ FRONT SUSPENSION



Super 8 50

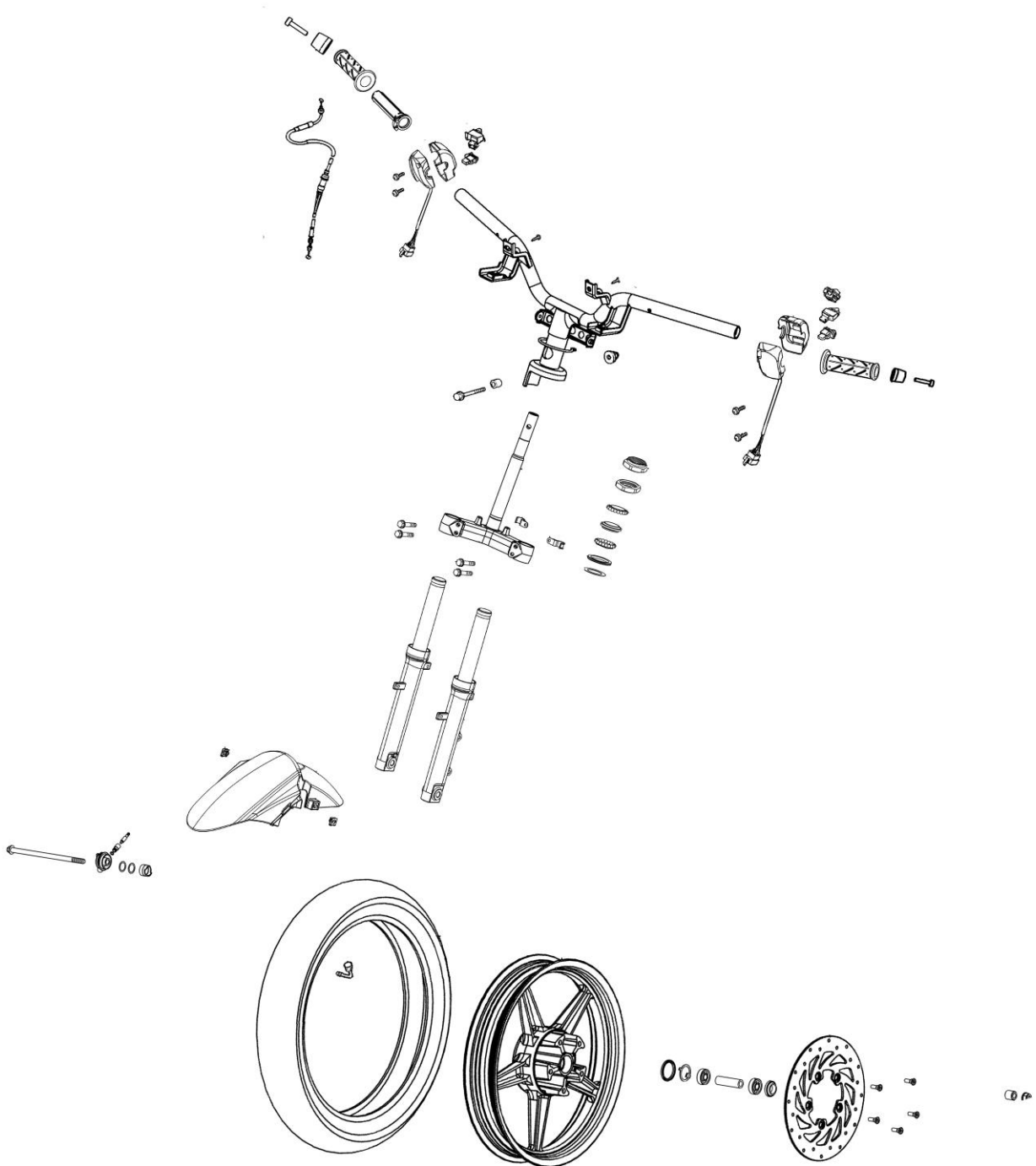

12

# 12. FRONT WHEEL/FRONT BRAKE/ FRONT SUSPENSION



Super 8 50

SERVICE INFORMATION .....	12-1	FRONT SHOCK ABSORBER.....	12-18
TROUBLESHOOTING .....	12-2	FRONT FORK.....	12-21
STEERING HANDLEBAR .....	12-3		
FRONT WHEEL.....	12-4		

## SERVICE INFORMATION

### GENERAL INSTRUCTIONS

- Remove the motorcycle frame covers before removing the front wheel. Jack the motorcycle front wheel off the ground and be careful to prevent the motorcycle from falling down.
- During servicing, keep oil or grease off the brake drum and brake linings.

### SPECIFICATIONS

Item		Standard (mm)	Service Limit (mm)
Axle shaft runout		—	0.2
Front wheel rim runout	Radial	—	2.0
	Axial	—	2.0
Front shock absorber spring free length		230	226.5

### TORQUE VALUES

Handlebar bolt	4.5~5.5kgf-m
Steering stem lock nut	6.0~8.0kgf-m
Steering top cone race	0.5~1.3kgf-m
Front shock absorber bolt	3.0kgf-m
Front axle nut	5.0~7.0kgf-m
Brake arm bolt	0.8~1.2kgf-m

### SPECIAL TOOLS

Long socket wrench,32mm 8angle

## TROUBLESHOOTING

### Hard steering (heavy)

- Excessively tightened steering stem top cone race
- Broken steering balls
- Insufficient tire pressure

### Steers to one side or does not track straight

- Uneven front shock absorbers
- Bent front fork
- Bent front axle or uneven tire

### Front wheel wobbling

- Bent rim
- Excessive wheel bearing play
- Bent spoke plate
- Faulty tire
- Improperly tightened axle nut

### Soft front shock absorber

- Weak shock springs
- Insufficient damper oil

### Front shock absorber noise

- Slider bending
- Loose fork fasteners
- Lack of lubrication

## 12. FRONT WHEEL/FRONT BRAKE/ FRONT SUSPENSION

### STEERING HANDLEBAR

#### REMOVAL

Remove the handlebar front and rear covers.  
(⇒2-2)

Remove the two bolts attaching each of the  
front and rear brake levers.

Remove the front and rear brake levers.

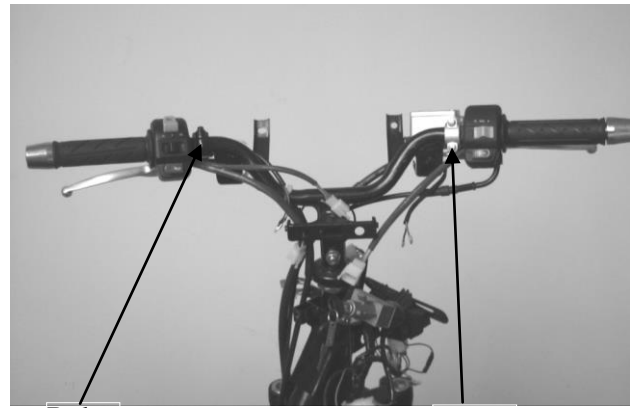

Bolts

Bolts

Remove the two throttle holder screws and  
throttle holder.

Disconnect the throttle cable from the throttle  
pipe and then remove the throttle pipe from  
the handlebar.

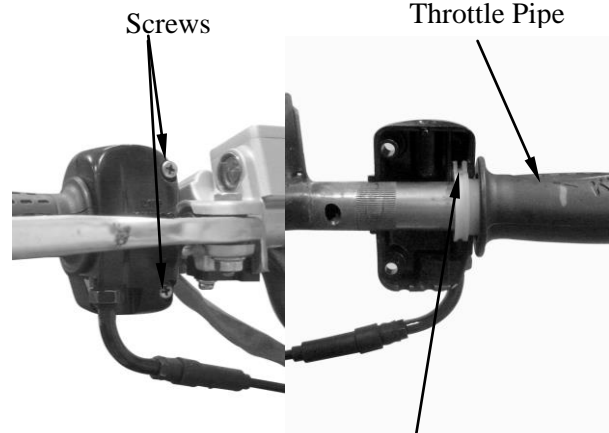

Screws

Throttle Pipe

Throttle Cable

Remove the handlebar lock nut and bolt to  
remove the handlebar.



Nut

Bolt

Bolt Orifice

#### INSTALLATION

Install the handlebar onto the steering stem by  
aligning the tab on the handlebar with the bolt  
orifice on the steering stem.

Install and tighten the handlebar bolt and lock  
nut.

**Torque:** 4.5~5.5kgf-m

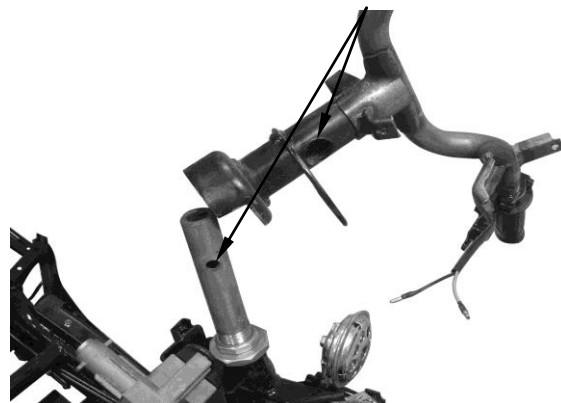

## 12. FRONT WHEEL/FRONT BRAKE/ FRONT SUSPENSION

Apply grease to the tip of the throttle pipe.  
Install the throttle pipe and connect the  
throttle cable.

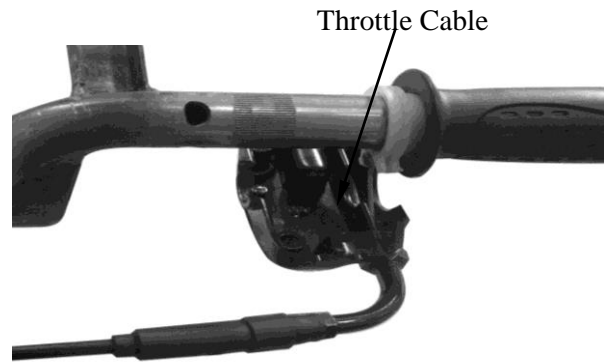

Install the front and rear brake levers in the  
reverse order of removal.

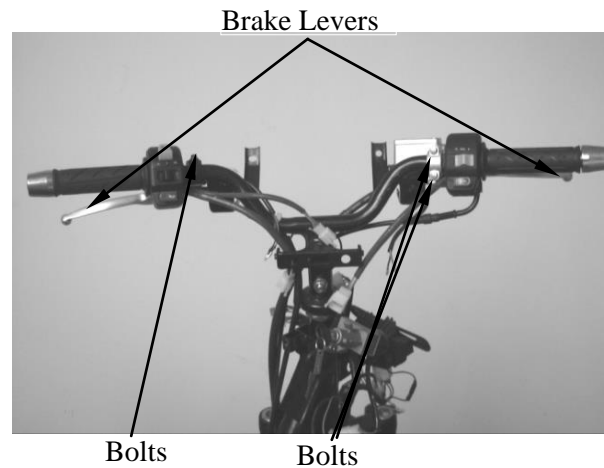

### FRONT WHEEL

#### REMOVAL

Jack the motorcycle front wheel off the  
ground.  
Remove the speedometer cable set screw and  
disconnect the speedometer cable.  
Remove the front axle nut and pull out the  
axle.  
Remove the front wheel.  
Remove the and speedometer gear box and  
side collar.

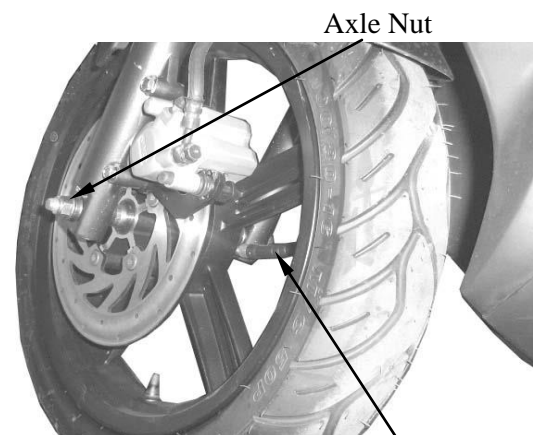

#### INSPECTION

##### AXLE RUNOUT

Set the axle in V blocks and measure the  
runout using a dial gauge.  
The actual runout is  $\frac{1}{2}$  of the total indicator  
reading.

**Service Limit:** 0.2mm replace if over

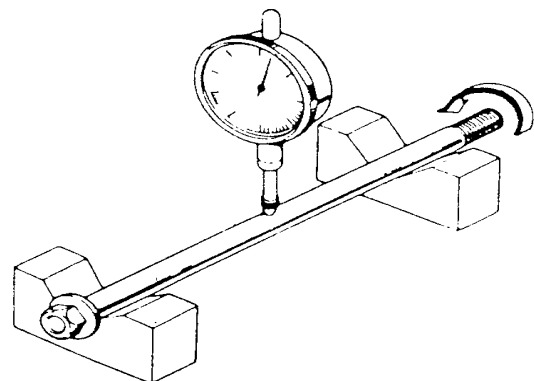

# 12. FRONT WHEEL/FRONT BRAKE/ FRONT SUSPENSION

### WHEEL RIM

Check the wheel rim runout.

#### Service Limits:

**Radial:** 2.0mm replace if over

**Axial:** 2.0mm replace if over

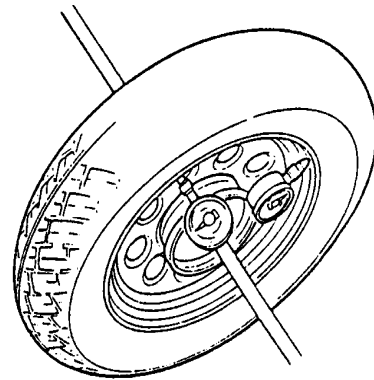

Turn the wheel bearings and replace the bearings if they are noisy or have excessive play.

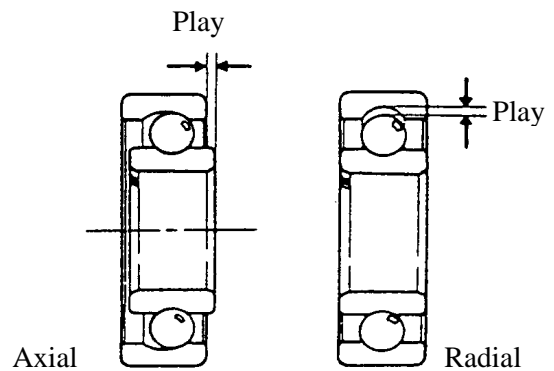

### DISASSEMBLY

Remove the dust seal.



Remove the front wheel bearings and distance collar.

**Special**

Bearing Puller

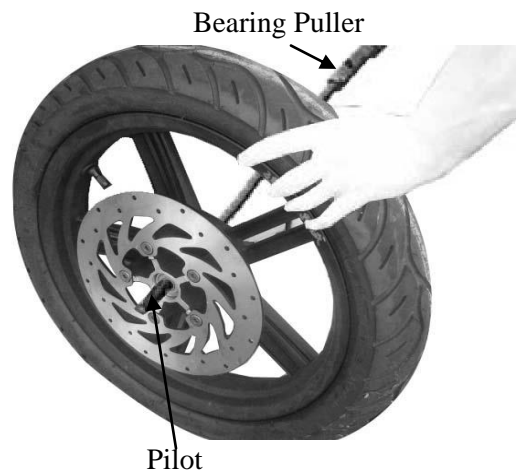

# 12. FRONT WHEEL/FRONT BRAKE/ FRONT SUSPENSION

## ASSEMBLY

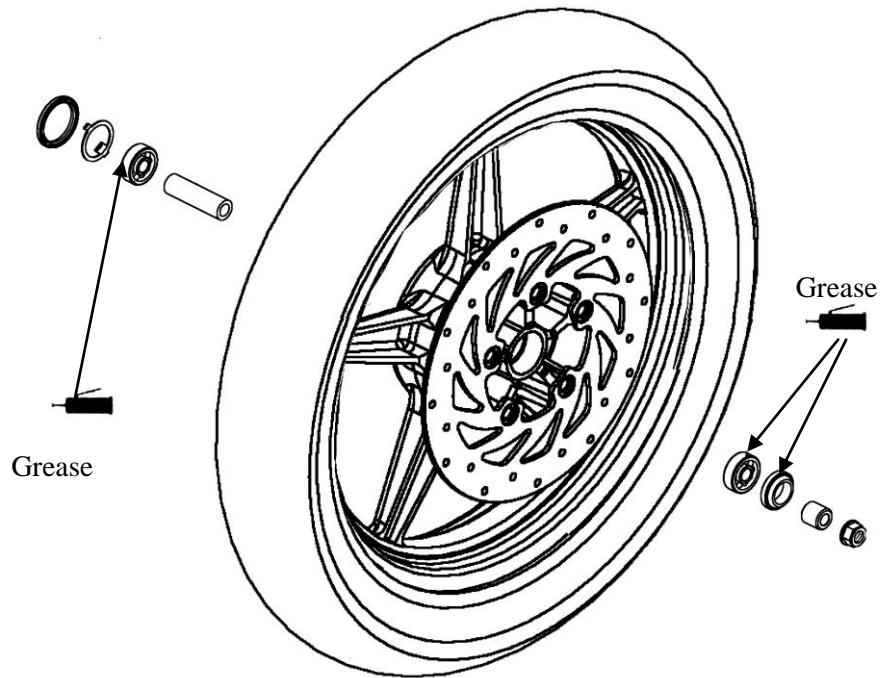

Pack all bearing cavities with grease.  
Drive in the left bearing.  
Install the distance collar.  
Drive in the right bearing.

\* Drive in the bearing squarely with the sealed end facing out.

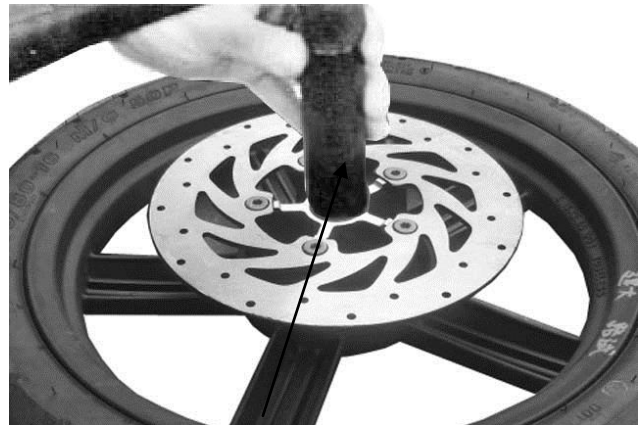

Outer Driver Pilot

Apply grease to a new dust seal lip and install the dust seal.  
Install the side collar.

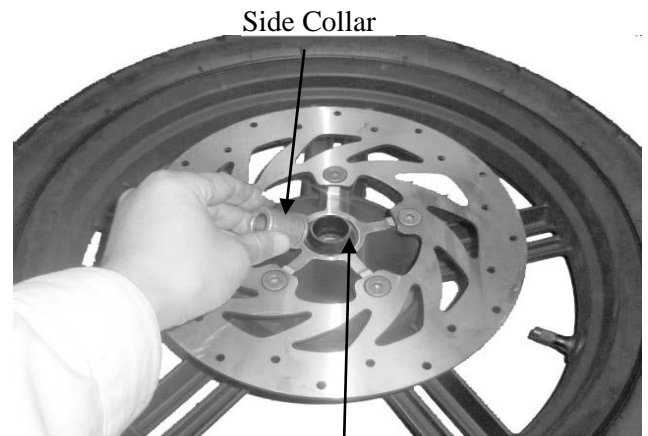

Dust Seal

## 12. FRONT WHEEL/FRONT BRAKE/ FRONT SUSPENSION

### HYDRAULIC BRAKE (FRONT BRAKE)

Brake Fluid Replacement/Air Bleeding

Check the brake fluid level on level ground.

\*

- When operating the brake lever, the brake reservoir cap must be tightened securely to avoid spill of brake fluid.
- When servicing the brake system, use shop towels to cover plastic parts and coated surfaces to avoid damage caused by spill of brake fluid.

Upper Limit

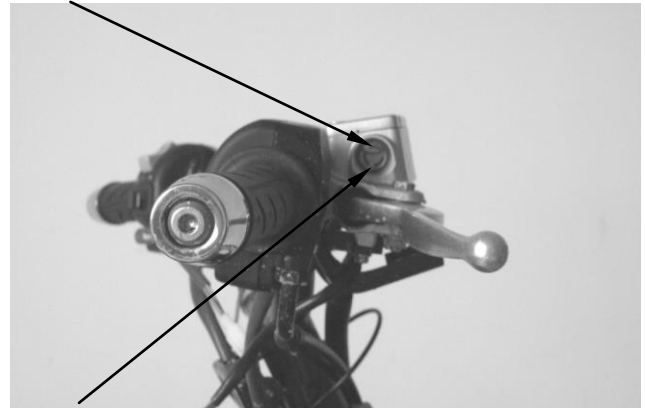

Lower Limit

### Brake Fluid Bleeding

In order to avoid spill of brake fluid, connect a transparent hose to the bleed valve.

#### Warning

Brake fluid spilled on brake pads or brake disk will reduce the braking effect. Clean the brake pads and brake disk with a high quality brake degreaser.

Fully apply the brake lever and then loosen the brake caliper bleed valve to drain the brake fluid until there is no air bubbles in the brake fluid. Then, tighten the bleed valve. Repeat these steps until the brake system is free of air.

Bleed Valve

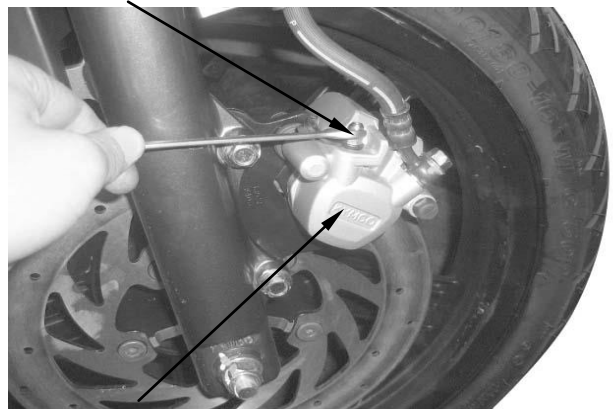

Front Brake Caliper

### Brake Fluid Refilling

Add DOT-4 brake fluid to the brake reservoir.

\*

- When bleeding, be careful not to allow air in the brake reservoir flowing into the brake system.
- When using a brake bleeder, follow the manufacturer's instructions.
- Never use dirty or unspecified brake fluid or mix different brake fluids because it will damage the brake

Make sure to bleed air from the brake system.



## Brake Pad/Disk Replacement

\* The brake pads must be replaced as a set to ensure the balance of the brake disk.

Remove the two bolts attaching the brake caliper.  
Remove the brake caliper.  
Downpress reed and remove the brake pads.  
Install the brake pads in the reverse order of removal.

\*  
• Keep grease or oil off the brake pads to avoid brake failure.

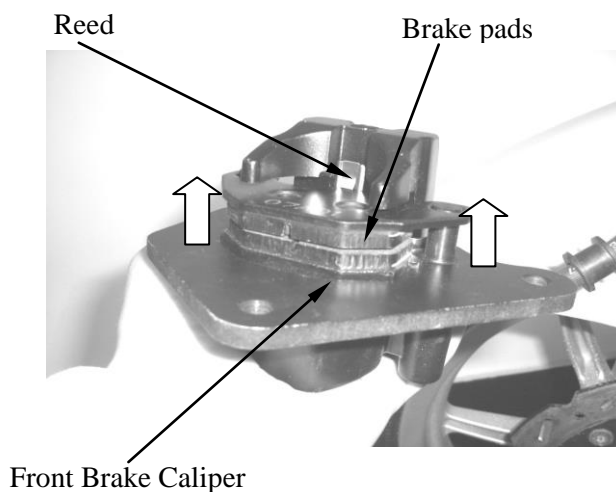

## Brake Disk

Measure the brake disk thickness.

**Service Limit:** 3.0mm

Measure the brake disk runout.

**Service Limit:** 0.3mm



## BRAKE MASTER CYLINDER

### Removal

First drain the brake fluid from the hydraulic brake system.

\*

- When servicing the brake system, use shop towels to cover rubber and plastic parts and coated surfaces to avoid being contaminated by brake fluid.
- When removing the brake fluid pipe bolt, be sure to plug the pipe to avoid brake fluid leakage.

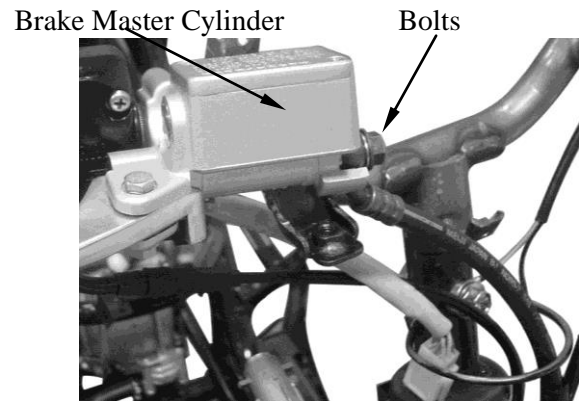

### Disassembly

Remove the piston rubber cover and snap ring from the brake master cylinder.

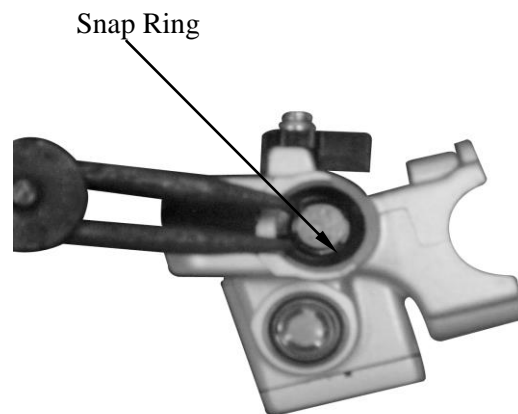

Remove the washer, main piston and spring from the brake master cylinder. Clean the inside of the master cylinder and brake reservoir with brake fluid.

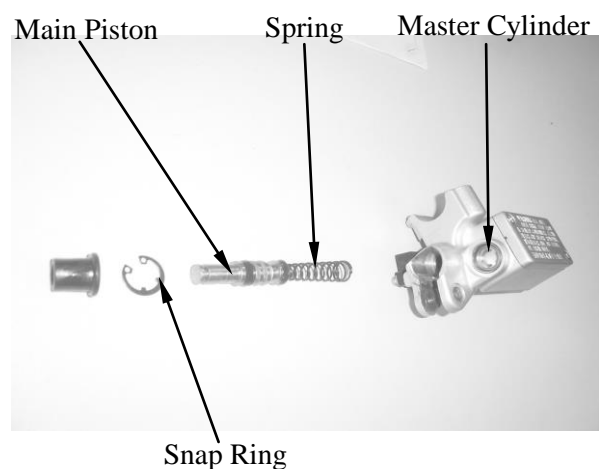

## 12. FRONT WHEEL/FRONT BRAKE/ FRONT SUSPENSION

### Inspection

Measure the brake master cylinder I.D.

**Service Limit:** 12.75mm

Inspect the master cylinder for scratch or crack.

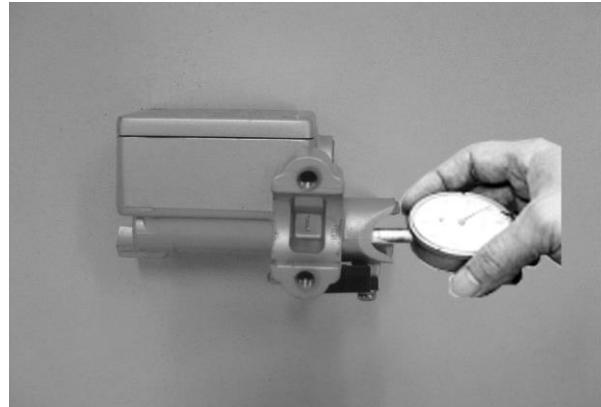

Measure the brake master cylinder piston O.D.

**Service Limit:** 12.6mm

Before assembly, inspect the 1st and 2nd rubber cups for wear.



### Assembly

Before assembly, apply brake fluid to all removed parts.

Install the spring together with the 1st rubber cup.

\*

- During assembly, the main piston and spring must be installed as a unit without exchange.
- When assembling the piston, soak the cups in brake fluid for a while.
- Install the cups with the cup lips facing the correct direction.

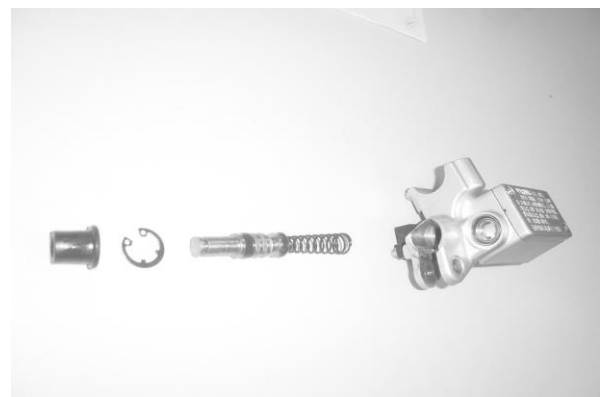

Install the main piston, spring and snap ring.

Install the rubber cover.

Install the brake lever.

## 12. FRONT WHEEL/FRONT BRAKE/ FRONT SUSPENSION

### Disassembly

Remove the brake caliper seat from the brake caliper.

Brake Caliper Seat

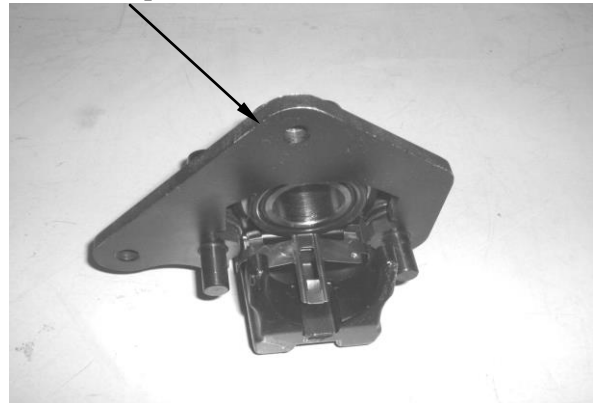

Remove the piston from the brake caliper. If necessary, use compressed air to squeeze out the piston through the brake fluid inlet opening and place a shop towel under the caliper to avoid contamination caused by the removed piston. Check the piston cylinder for scratch or wear and replace if necessary.

Compressed Air



Push the piston oil seal outward to remove it. Clean the oil seal groove with brake fluid.

\*

Be careful not to damage the piston surface.

Piston Oil Seal

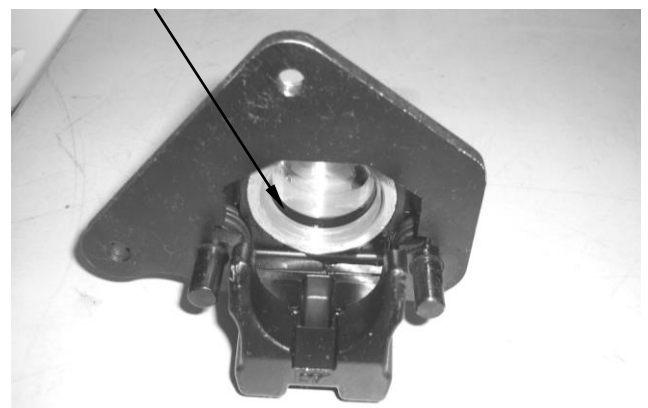

## 12. FRONT WHEEL/FRONT BRAKE/ FRONT SUSPENSION

Place the brake master cylinder on the handlebar and install the holder with “up” mark facing up. Be sure to align the punch mark with the holder joint. First tighten the upper bolt and then tighten the lower bolt.

**Torque:** 3.0~4.0kgf-m

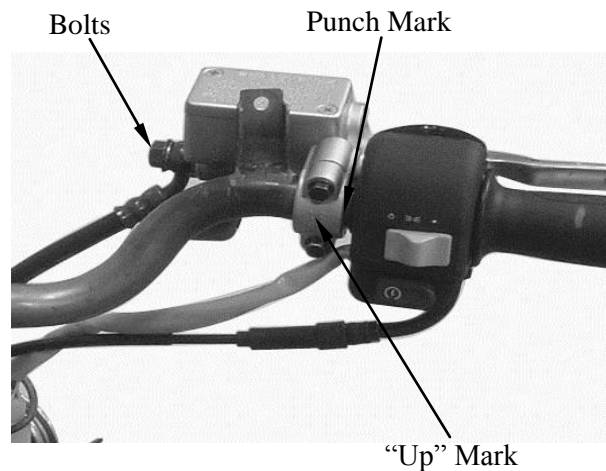

Install the brake fluid pipe with the attaching bolt and two sealing washers.

Install the handlebar covers. (⇒ 12-3)  
Fill the brake reservoir with recommended brake fluid to the upper limit and bleed air according to the method stated in 12-10.

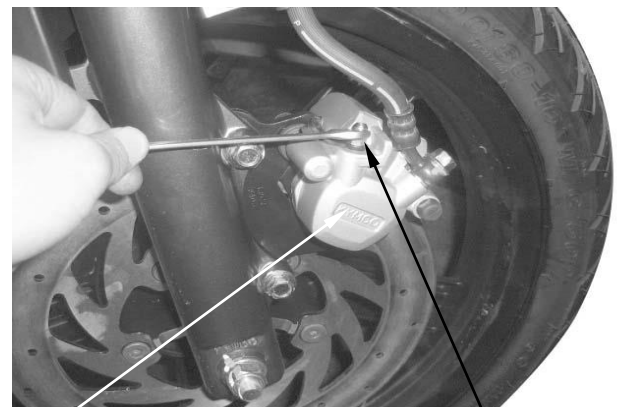

Brake Caliper

Bleed Valve

### **BRAKE CALIPER (FRONT)**

#### **Removal**

Remove the brake caliper.  
Place a clean container under the brake caliper and disconnect the brake fluid pipe from the caliper.

\* Do not spill brake fluid on any coated surfaces.

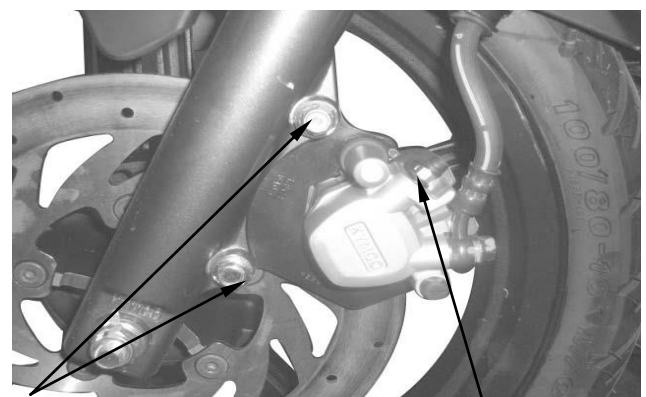

Bolt

Bleed Valve

## 12. FRONT WHEEL/FRONT BRAKE/ FRONT SUSPENSION

Check the piston for scratch or wear.

Measure the piston O.D. with a micrometer.

**Service Limit:** 34mm



Check the caliper cylinder for scratch or wear  
and measure the cylinder bore.

**Service Limit:** 34.5mm

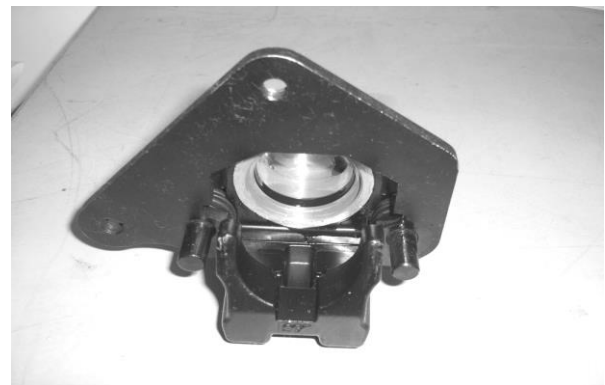

### Assembly

Clean all removed parts.

Apply silicon grease to the piston and oil seal.

Lubricate the brake caliper cylinder inside

wall with brake fluid.

Install the brake caliper piston with grooved  
side facing out.

\*

Install the piston with its outer end 3~  
5mm protruding beyond the brake  
caliper.

Wipe off excessive brake fluid with a clean  
shop towel. Apply silicon grease to the  
brake caliper seat pin and caliper inside.

Install the brake caliper seat.



## 12. FRONT WHEEL/FRONT BRAKE/ FRONT SUSPENSION

### Installation

Install the brake caliper and tighten the two bolts.

**Torque:** 2.9~3.5kg-m

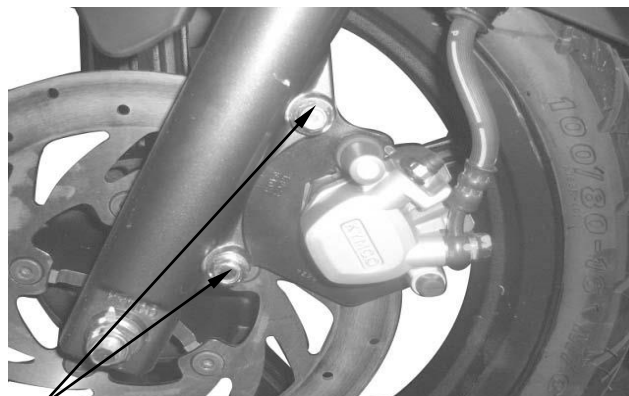

Bolts

Connect the brake fluid pipe to the brake caliper and tighten the fluid pipe bolt.

**Torque:** 2.5~3.5kg-m

Fill the brake reservoir with recommended brake fluid and bleed air from the brake system. (⇒12-10)



Bolt

## 12. FRONT WHEEL/FRONT BRAKE/ FRONT SUSPENSION

### FRONT SHOCK ABSORBER

#### REMOVAL

Remove the front wheel. (⇒12-4)  
Remove the front lower cover. (⇒2-2)  
Remove the front inner fender.  
Remove the front shock absorber upper mount bolts.  
Loosen the lower mount bolts to remove the front shock absorbers.



#### DISASSEMBLY

Remove the dust boot.  
Remove the circlip.

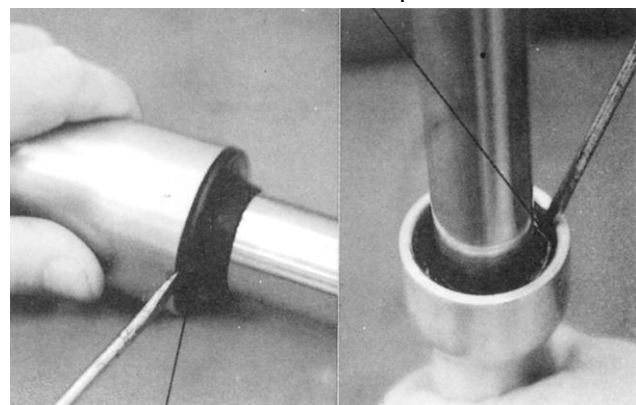

Set the front shock absorber in a vise.  
Remove the damper rod, hex bolt and copper washer.  
Pull out the front shock absorber tube.

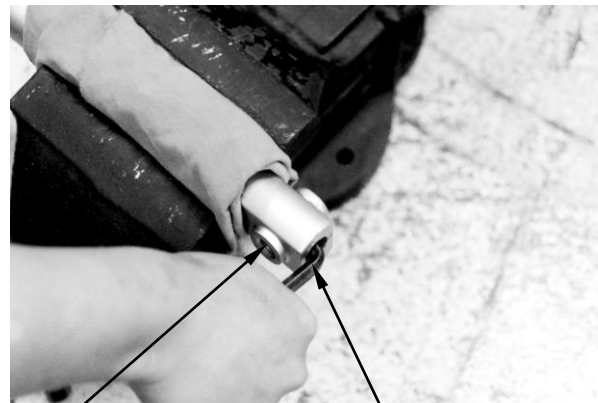

Set the front shock absorber tube in a vise.  
Remove the top nut, shock spring, damper, and damper spring from the front shock absorber tube.

- \* • When holding the shock absorber tube, place a shop towel to protect it and do apply too much force .

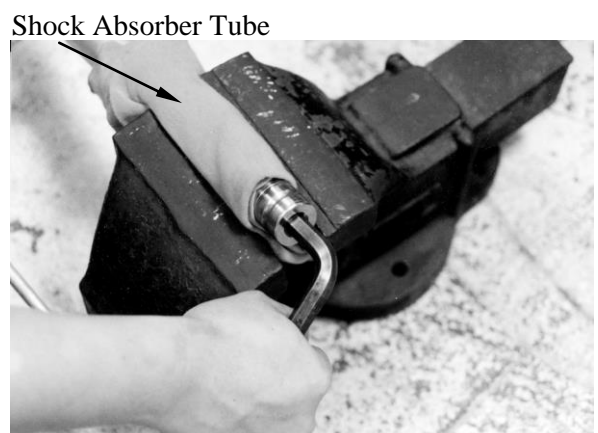



# 12. FRONT WHEEL/FRONT BRAKE/ FRONT SUSPENSION

Measure the front shock absorber spring free length.

**Service Limits:** Right : 226.5mm  
Left : 226.5mm

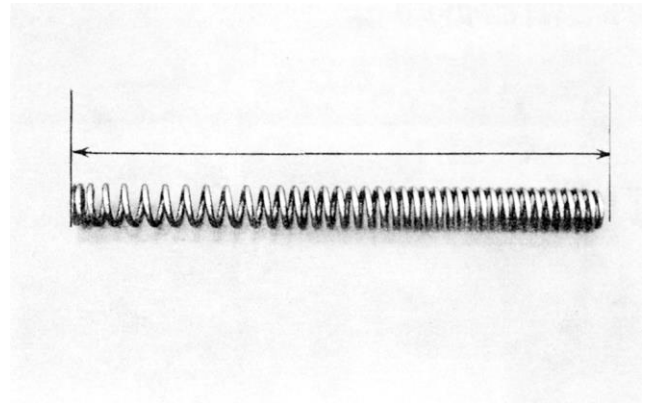

## ASSEMBLY

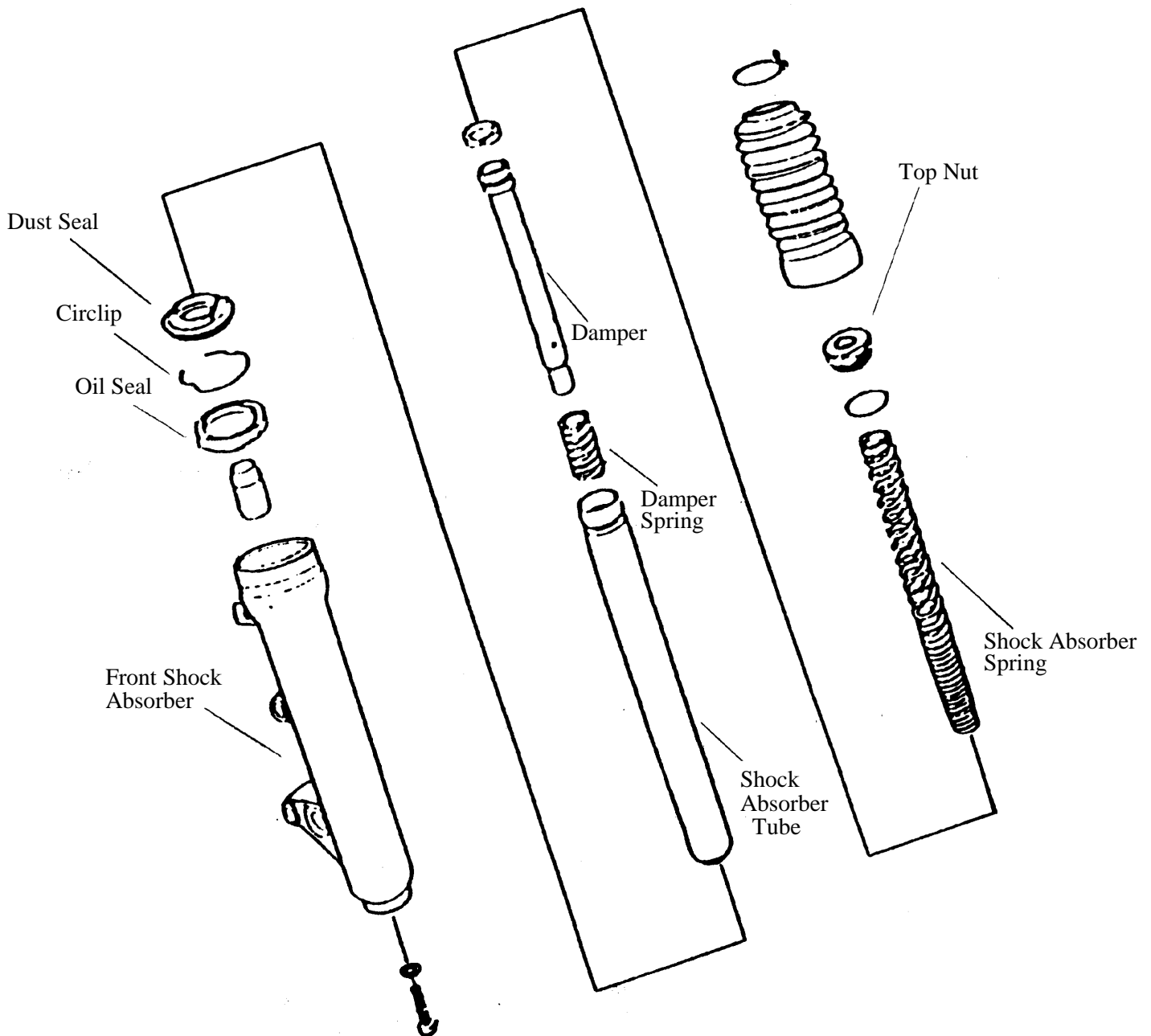

Install the damper spring onto the damper rod and then install them into the front shock

## 12. FRONT WHEEL/FRONT BRAKE/ FRONT SUSPENSION

absorber tube.

Install the shock absorber spring onto the front shock absorber tube and tighten the top nut.

\* Install the front shock absorber spring with the closely wound coils facing down.



Shock Absorber Tube  
Circlip

Set the front shock absorber in a vise.

Insert the shock absorber tube into the shock absorber and tighten the hex bolt.

(Apply locking agent to the washer and install it together with the hex bolt.)

**Torque:** 3.0kgf-m

Add engine oil into the front shock absorber.

**Specified Oil:** SS#8

**Oil Capacity:** 97±1cc

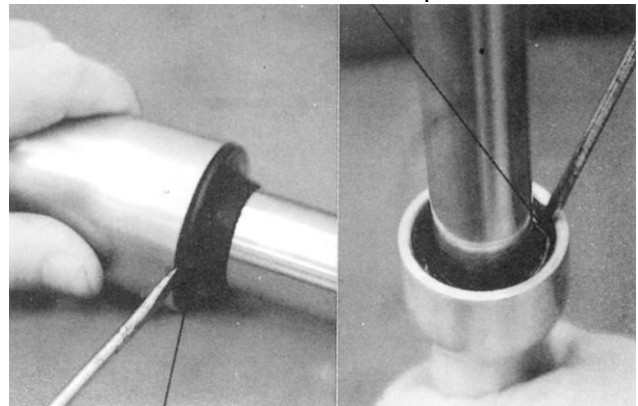

Dust Boot

Install the circlip.

Install the dust boot.

Upper Mount Bolts



Front Shock Absorber

Lower Mount Bolts

### INSTALLATION

Install the front shock absorbers onto the steering stem.

Install and tighten the front shock absorber upper mount bolts.

Tighten the lower mount bolts.

\* Align the upper mount bolt hole with the groove on the front fork.

Install the front wheel. (⇒12-7)

# 12. FRONT WHEEL/FRONT BRAKE/ FRONT SUSPENSION

## FRONT FORK

### REMOVAL

Remove the steering handlebar. (⇒12-3)  
Remove the front wheel. (⇒12-4)  
Disconnect the speedometer cable.  
Remove the steering stem lock nut using long socket wrench.

**Special**

Long Socket Wrench, 32mm 8Angle

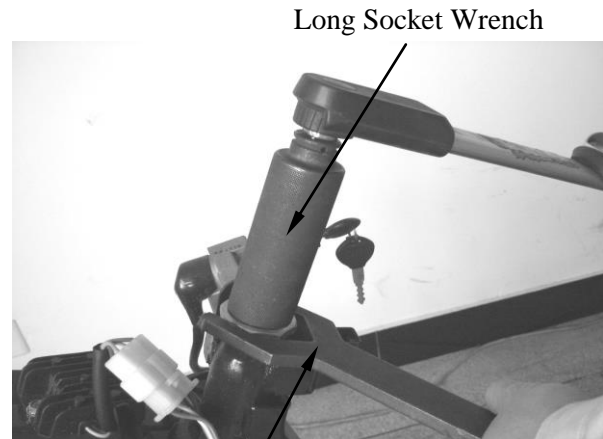

Lock Nut Wrench

Remove the top cone race and remove the steering stem.

- \* Be careful not to lose the steel balls (26 on top race and 29 on bottom race).

Inspect the ball races and cone races for wear or damage and replace if necessary.

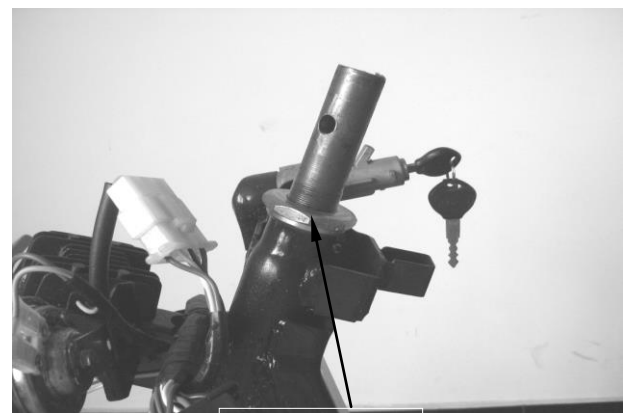

Top Cone Race

### BOTTOM CONE RACE REPLACEMENT

Remove the bottom cone race using a chisel.

- \* Be careful not to damage the steering stem and front fork.

Drive a new bottom cone race into place with a proper driver.

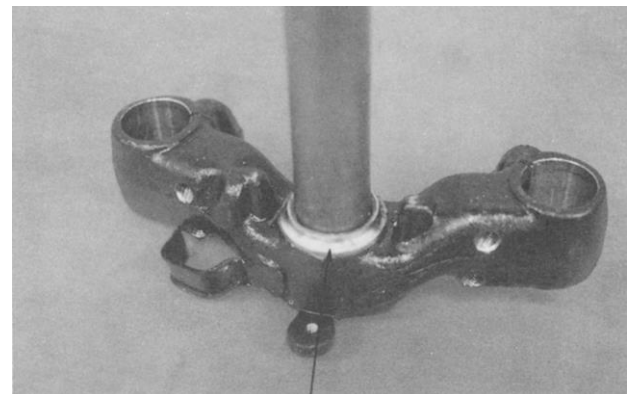

Bottom Cone Race

### BALL RACE REPLACEMENT

Drive out the top and bottom ball races.

Ball Race Remover

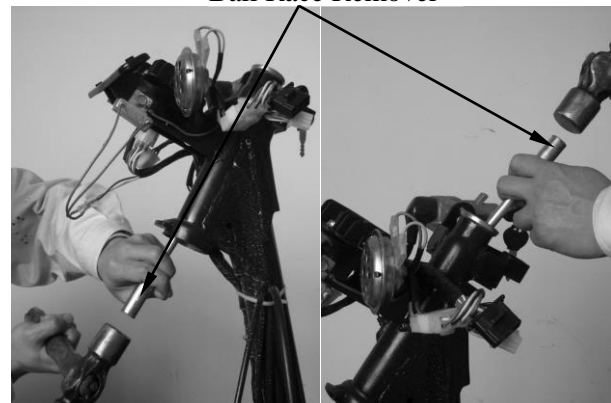

## 12. FRONT WHEEL/FRONT BRAKE/ FRONT SUSPENSION

Drive new top and bottom ball races into the steering head using the outer driver.

- \* Be sure to completely drive in the ball races.

### INSTALLATION

Apply grease to the top and bottom ball races and install 26 steel balls on the top ball race and 29 steel balls on the bottom ball race. Apply grease to the ball races and install the front fork.

Apply grease to the top cone race and install it.

Tighten the top cone race and then turn the steering stem right and left several times to make steel balls contact each other closely.

- \* Check that the steering stem rotates freely without vertical play.

Install the steering stem lock nut and tighten it while holding the top cone race.

**Torque:** 6.0~8.0kgf-m

Install the front wheel. (⇒12-7)

Install the steering handlebar. (⇒12-3)

Install the speedometer cable. (⇒12-7)

**Special**

Long Socket Wrench, 32mm × 8 Angle

Driver Handle A



Outer Driver, 37x40mm

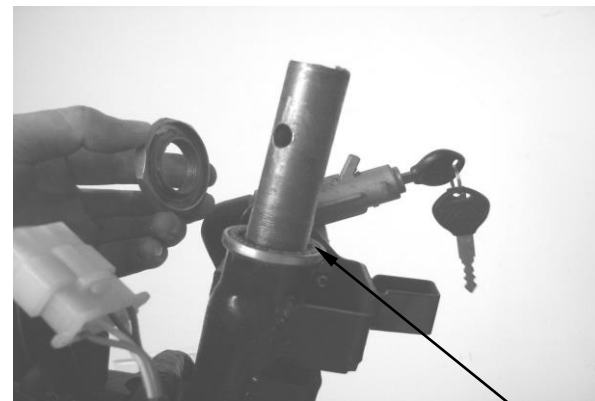

Steel Balls

Top Cone Race

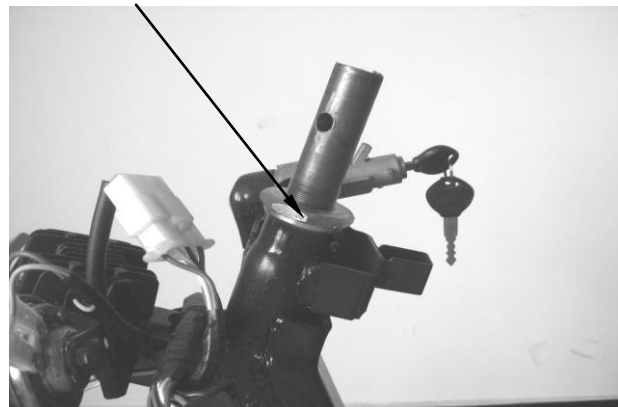

Long Socket Wrench

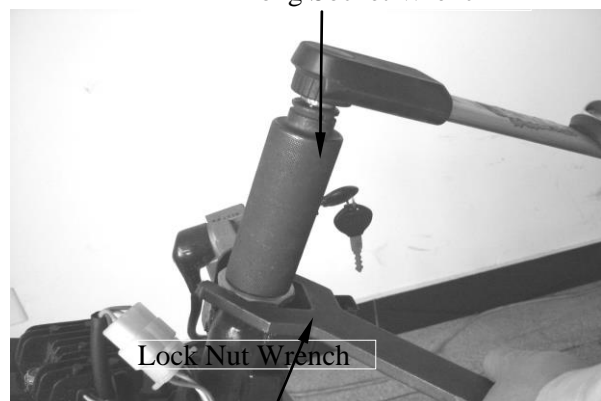

# 13. REAR WHEEL/REAR BRAKE/REAR SHOCK ABSORBER

---

Super 8 50

---

## REAR WHEEL/REAR BRAKE/REAR SHOCK ABSORBER

---

SERVICE INFORMATION .....	13-2
TROUBLESHOOTING .....	13-2
REAR BRAKE.....	13-3
REAR WHEEL .....	13-7
REAR SHOCK ABSORBER .....	13-8

# 13. REAR WHEEL/REAR BRAKE/REAR SHOCK ABSORBER

Super 8 50

KP10AA(IT) F08

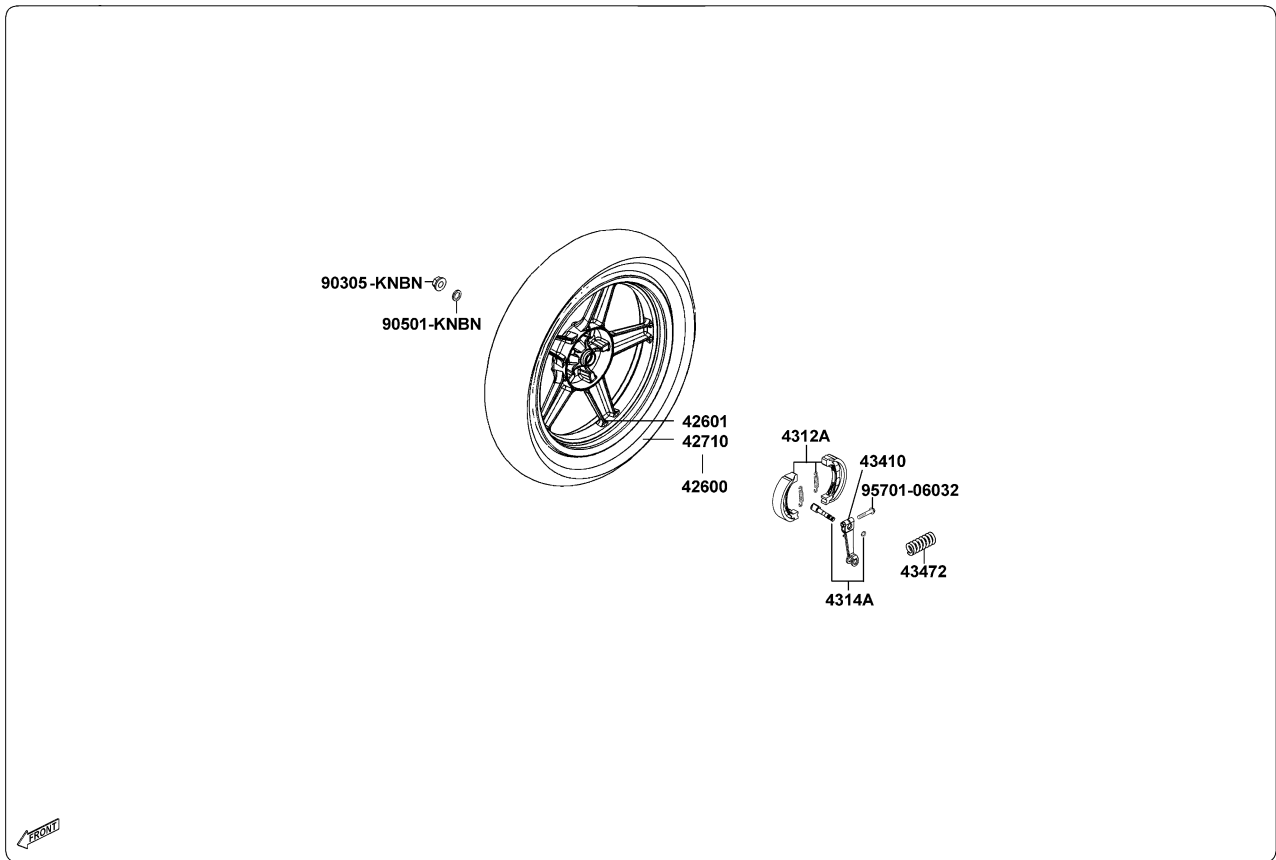

FRONT

KP10AA(IT) F17

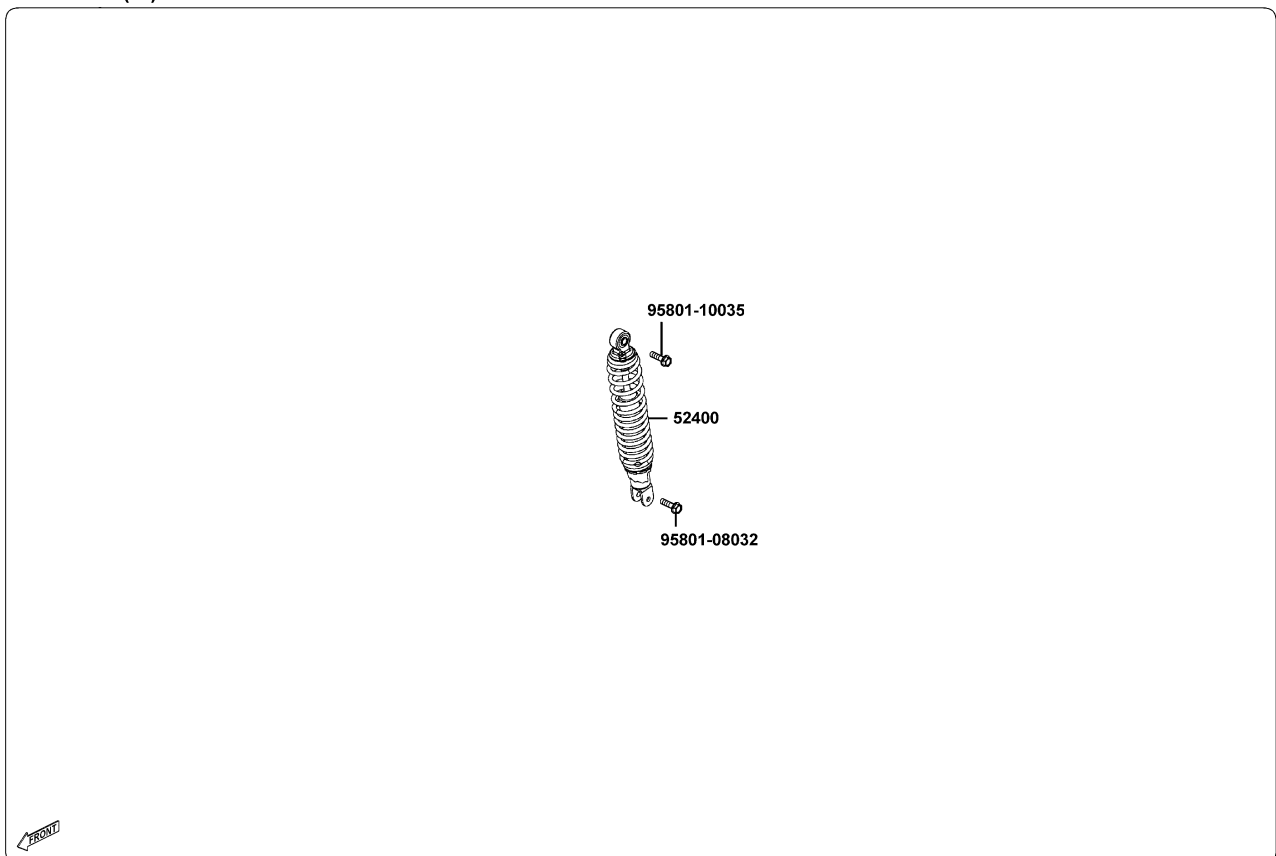

FRONT

# 13. REAR WHEEL/REAR BRAKE/REAR SHOCK ABSORBER

Super 8 50

## SERVICE INFORMATION

### GENERAL INSTRUCTIONS

\*When performing the service stated in this section, the engine and exhaust muffler must be cold to avoid scalding.

\*During servicing, keep oil or grease off the brake pads and brake disk.

### REAR SHOCK ABSORBER REMOVAL

Remove the met-in box.

Remove the frame body cover

Remove the suspension upper mount bolt

Remove the suspension lower mount bolt

Remove the rear shock absorber

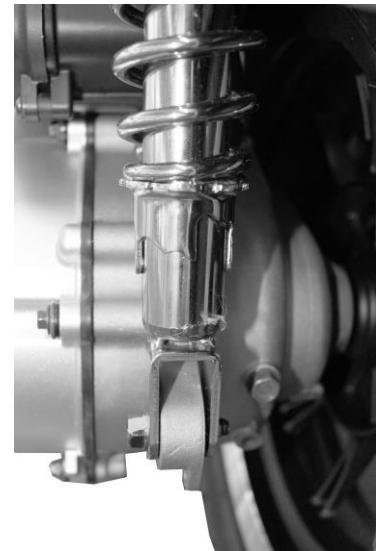

### INSTALLATION

Install the upper and lower mount bolts.

Install the frame body cover.

**Torque:**

**Upper Mount Bolt:** 35~45Nm

**Lower Mount Bolt:** 24~30Nm

### REAR WHEEL REMOVAL

Disconnect the connector of O<sub>2</sub> sensor.

Remove the muffler mount bolts

Remove the muffler.

Remove the rear axle mount bolt

Remove the rear wheel.



### INSTALLATION

Install the rear wheel in reverse order of removal.

**Torque:**

**Rear axle Mount Bolt:** 110~130Nm

**Muffler Mount Bolts:** 35 Nm

**Muffler Joint Bolts:** 12Nm

# 13. REAR WHEEL/REAR BRAKE/REAR SHOCK ABSORBER

Super 8 50

## REAR BRAKE REMOVAL BRAKE LINING INSPECTION

Measure the brake lining thickness.  
Service Limit: 2.0mm replace if below

\* Keep oil or grease off the brake linings.

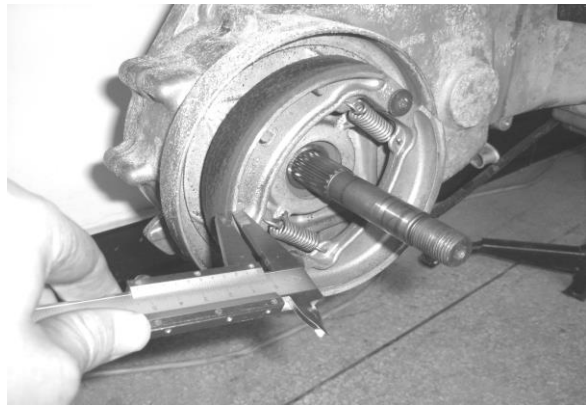

## REAR BRAKE DISASSEMBLY

Remove the rear brake adjusting nut and disconnect the rear brake cable.  
Remove the rear brake shoes.

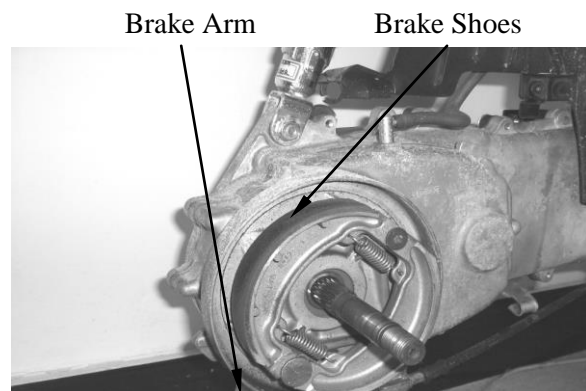

Remove the brake arm bolt to remove the brake arm.  
Remove the brake cam.

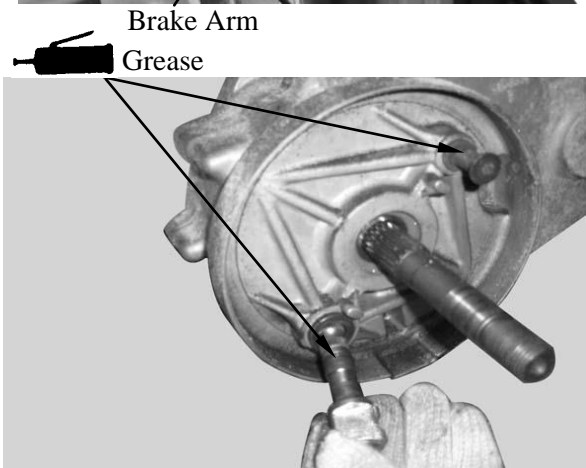
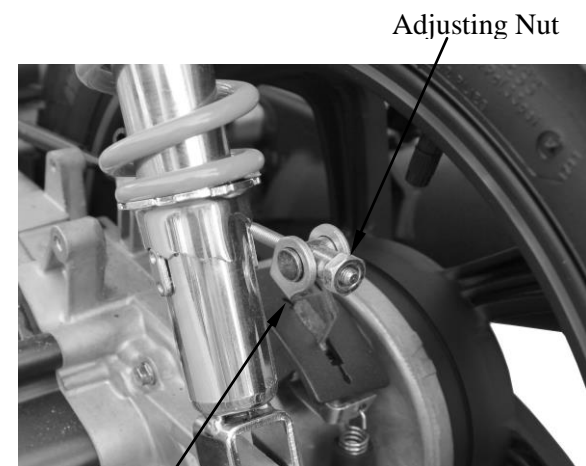

## REAR BRAKE ASSEMBLY

Apply grease to the anchor pin.  
Apply grease to the brake cam and install it.  
Install the brake shoes.



# 13. REAR WHEEL/REAR BRAKE/REAR SHOCK ABSORBER

Super 8 50

Apply a small amount of engine oil to the felt seal and install it to the brake cam.  
Install the brake arm.

- \* Align the wide groove on the wear indicator plate with the wide tooth of the brake cam.

Install and tighten the brake arm bolt.

- \* Align the scribed line on the brake arm with the punch mark on the brake cam.

Install the brake arm return spring.  
Install the brake arm pin.  
Connect the brake cable and install the adjusting nut.  
Install the rear wheel. (⇒13-2)  
Adjust the rear brake lever free play. (⇒3-8)



Return Spring      Brake Arm  
Brake Cable      Brake Arm



Adjusting Nut

# 14. BATTERY/CHARGING SYSTEM/ A.C. GENERATOR

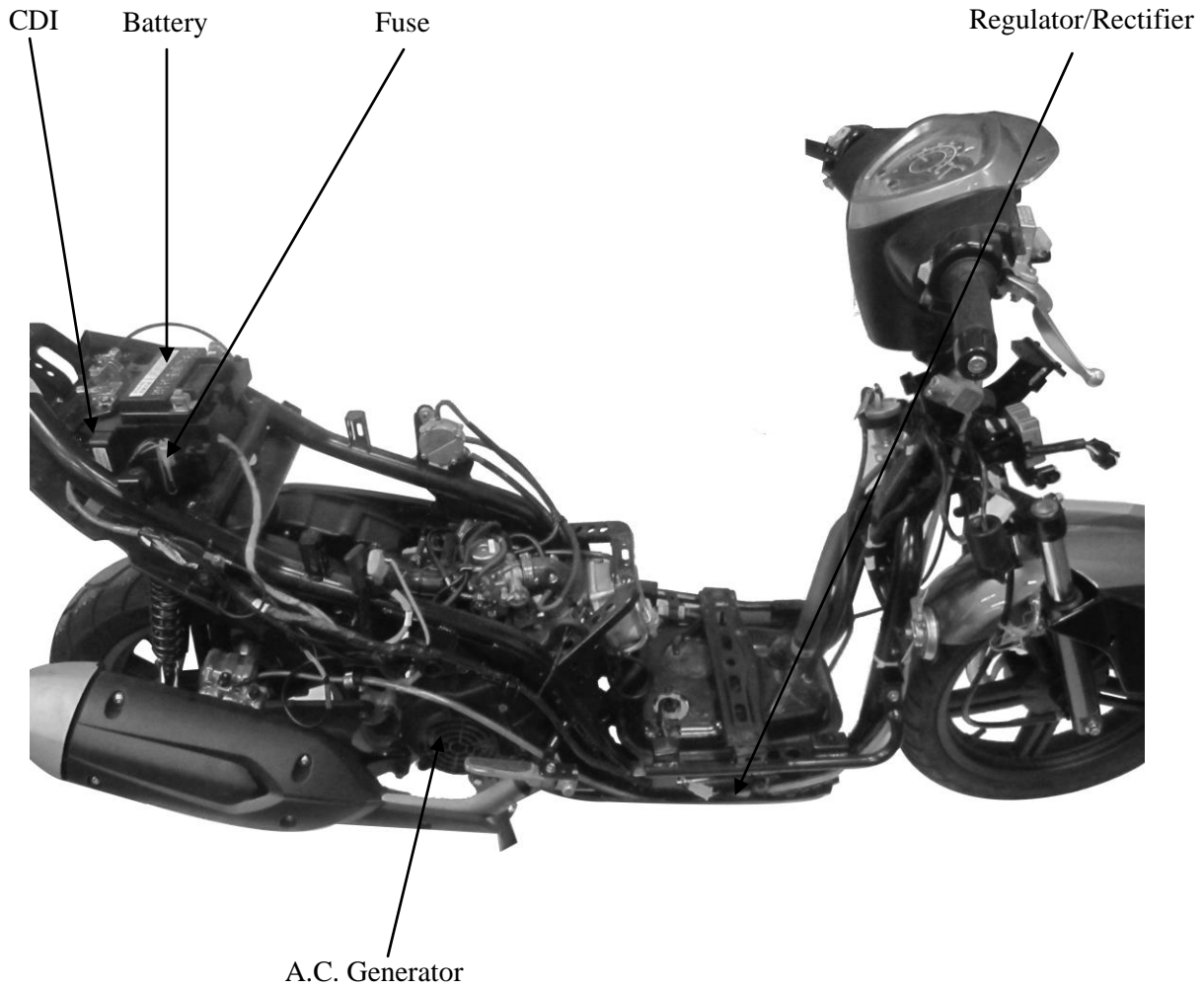

**14**

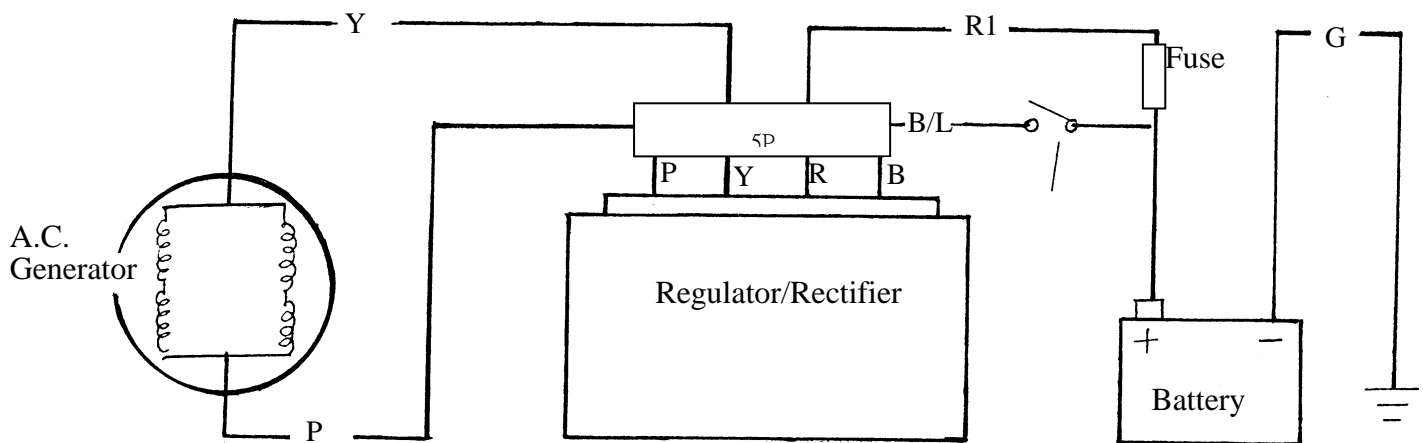

SERVICE INFORMATION.....	14-1	A.C. GENERATOR CHARGING COIL....	14-6
TROUBLESHOOTING.....	14-2	RESISTOR INSPECTION.....	14-6
BATTERY.....	14-3	A.C. GENERATOR REMOVAL .....	14-6
CHARGING SYSTEM .....	14-4	A.C. GENERATOR INATALLATION....	14-8
REGULATOR/RECTIFIER.....	14-5		

## SERVICE INFORMATION

### GENERAL INSTRUCTIONS



The battery electrolyte (sulfuric acid) is poisonous and may seriously damage the skin and eyes. Avoid contact with skin, eyes, or clothing. In case of contact, flush with water and get prompt medical attention

- The battery can be charged and discharged repeatedly. If a discharged battery is not used for a long time, its service life will be shortened. Generally, the capacity of a battery will decrease after it is used for 2~3 years. A capacity-decreased battery will resume its voltage after it is recharged but its voltage decreases suddenly and then increases when a load is added.
- When a battery is overcharged, some symptoms can be found. If there is a short circuit inside the battery, no voltage is produced on the battery terminals. If the rectifier won't operate, the voltage will become too high and shorten the battery service life.
- If a battery is not used for a long time, it will discharge by itself and should be recharged every 3 months.
- A new battery filled with electrolyte will generate voltage within a certain time and it should be recharged when the capacity is insufficient. Recharging a new battery will prolong its service life.
- Inspect the charging system according to the sequence specified in the Troubleshooting.
- Do not disconnect and soon reconnect the power of any electrical equipment because the electronic parts in the regulator/rectifier will be damaged. Turn off the ignition switch before operation.
- It is not necessary to check the MF battery electrolyte or fill with distilled water.
- Check the load of the whole charging system.
- Do not quick charge the battery. Quick charging should only be done in an emergency.
- Remove the battery from the motorcycle for charging.
- When replacing the battery, do not use a traditional battery.
- When charging, check the voltage with an voltmeter.

# 14. BATTERY/CHARGING SYSTEM/ A.C. GENERATOR

## SPECIFICATIONS

Item		Standard	
Battery	Capacity/Model	12V-6AH	
	Voltage (20°C)	Fully charged	13.1V
		Undercharged	12.3V
	Charging current	STD: 0.4A Quick: 4.0A	
	Charging time	STD: 5~10hr Quick: 30min	
A.C. Generator	Capacity	0.144KW/5000rpm	
	Charging coil resistance (20°C)	Yellow~Peach 0.1~1.0Ω	
Regulator/Rectifier	Type	Single-phase full-wave SCR	
	Limit voltage		
		Charging	14.5±0.5V/5000rpm
Resistor	Resistance (20°C)	5W12Ω	

## TORQUE VALUES

Pulser coil bolt	0.45~0.6kgf-m
Stator bolt	0.8~1.2kgf-m
Flywheel nut	3.5~4.5kgf-m
Cooling fan bolt	0.8~1.2kgf-m

## SPECIAL TOOLS

Universal holder  
Flywheel puller

## TESTING INSTRUMENTS

Kowa electric tester  
Sanwa electric tester

## TROUBLESHOOTING

### No power

- Dead battery
- Disconnected battery cable
- Fuse burned out
- Faulty ignition switch

### Low power

- Weak battery
- Loose battery connection
- Charging system failure
- Faulty regulator/rectifier

### Intermittent power

- Loose battery cable connection
- Loose charging system connection
- Loose connection or short circuit in lighting system

### Charging system failure

- Loose, broken or shorted wire or connector
- Faulty regulator/rectifier
- Faulty A.C. generator

# 14. BATTERY/CHARGING SYSTEM/ A.C. GENERATOR

## BATTERY

### REMOVAL

Remove the battery cover screws on the floor board.

Open the battery cover and remove the battery by removing the bolt and band.

First disconnect the battery negative (-) cable and then the positive (+) cable.

When disconnecting the battery positive (+) cable, do not touch the frame with tool; otherwise it will cause short circuit and sparks to fire the fuel.

The installation sequence is the reverse of removal.

First connect the positive (+) cable and the negative (-) cable to avoid short circuit.

### BATTERY VOLTAGE (OPEN CIRCUIT VOLTAGE) INSPECTION

Remove the floor board.

Open the battery cover and disconnect the battery cables.

Measure the voltage between the battery terminals.

Fully charged : 13.1V

Undercharged: 12.3V max.

\* Battery charging inspection must be performed with a voltmeter.

### CHARGING

Connect the charger positive (+) cable to the battery positive (+) terminal.

Connect the charger negative (-) cable to the battery negative (-) terminal.

• Keep flames and sparks away from a charging battery.  
• Turn power ON/OFF at the charger, not at the battery terminals to prevent sparks near the battery to avoid explosion.  
• Charge the battery according to the current specified on the battery.

\* • Quick charging should only be done in an emergency.  
• Measure the voltage 30 minutes after the battery is charged.

Charging current: Standard : 0.4A

Quick : 4A

Charging time : Standard : 5~10 hours

Quick : 30 minutes

After charging: Open circuit voltage: 12.8V min.

Note: The battery temperature should not exceed 45°C during charging.

Battery Cover



battery

negative (-) cable



positive (+) cable

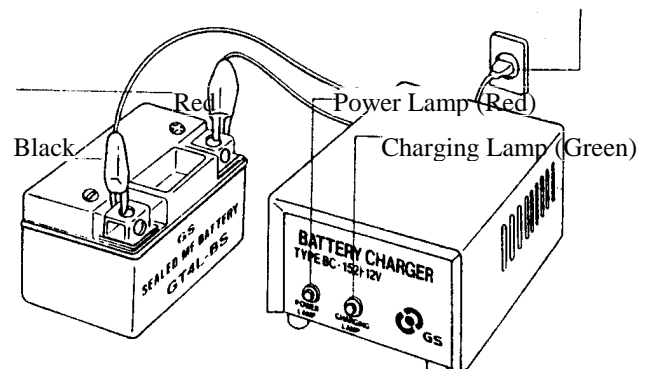
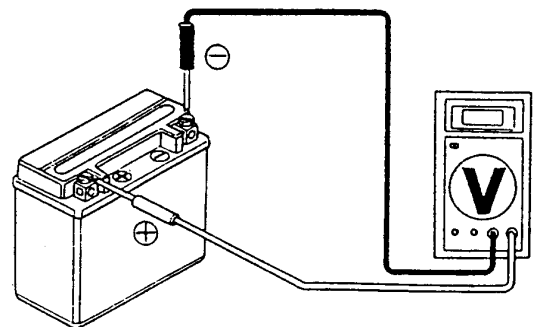

## CHARGING SYSTEM

### SHORT CIRCUIT TEST

Disconnect the ground wire from the battery and connect an ammeter across the battery negative (-) terminal and the ground wire. Turn the ignition switch OFF and check for short circuit.

\* Connect the electric tester positive (+) terminal to ground wire and the tester negative (-) terminal to the battery negative (-) terminal.

If any abnormality is found, check the ignition switch and wire harness for short circuit .

### CURRENT TEST

This inspection must be performed with an electric tester when the battery is fully charged.

Warm up the engine for inspection.

Connect the electric tester across the battery terminals. Disconnect the fuse and connect an ammeter between the fuse terminals.

Attach a tachometer to the engine.

Start the engine and gradually increase the engine speed to measure the limit voltage and current.

**Limit Voltage/Current:** 14~15V/0.5A max.  
(5000rpm max.)

If the limit voltage is not within the specified range, check the regulator/rectifier. (⇒14-5)

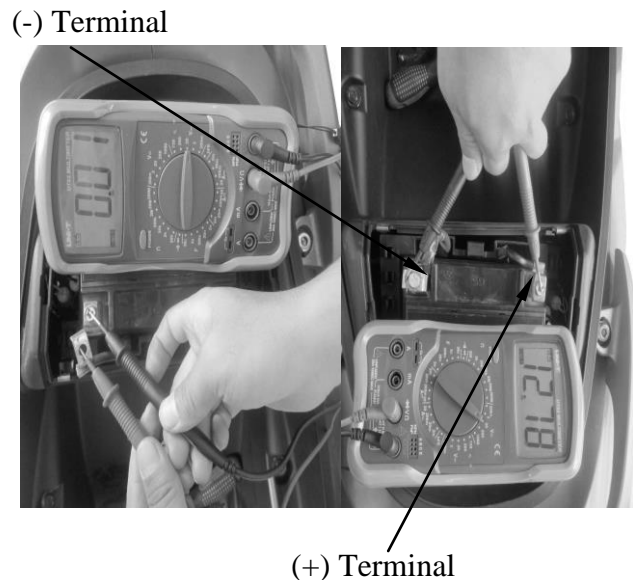
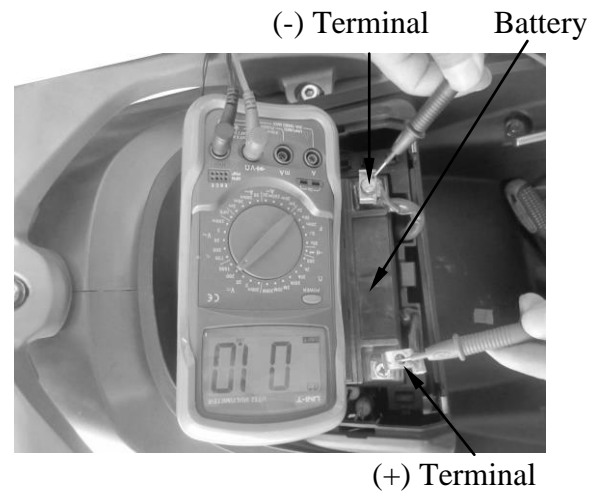

# 14. BATTERY/CHARGING SYSTEM/ A.C. GENERATOR

## REGULATOR/RECTIFIER

### MAIN HARNESS CIRCUIT INSPECTION

Remove the front covers. (⇒2-2)  
Remove the regulator/rectifier 4P coupler and check for continuity between the wire harness terminals according to the following :

Item (Wire Color)	Judgment
Between battery (red) and engine ground	Battery has voltage
Between ground (green) and engine ground	Continuity exists
Between c.d.i wire (black/blue) and engine ground (Remove the auto bystarter coupler and turn the lighting switch OFF for inspection)	A.C. generator stator nought resistance
Between charging coil (yellow or peach) and engine ground	A.C. generator stator nought resistance

Regulator/Rectifier

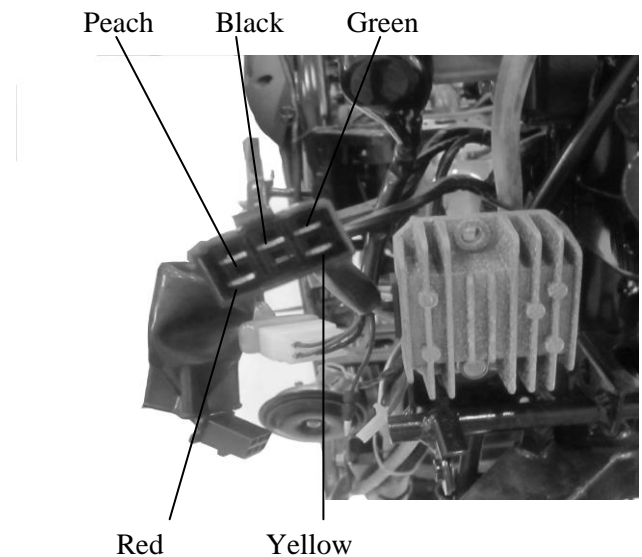
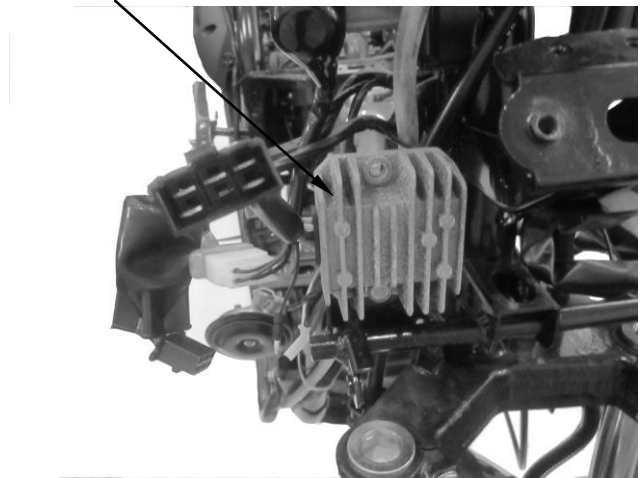

## REGULATOR/RECTIFIER

### REMOVAL

Remove the regulator/rectifier lock nut and disconnect the regulator/rectifier wire coupler.  
Measure the resistances between the regulator/rectifier wire terminals. Replace the regulator/rectifier if the readings are not within the specifications in the table below.

- \***
- Due to the semiconductor in circuit, it is necessary to use a specified tester for accurate testing. Use of an improper tester or measurements in an improper range may give false readings.
  - Use a Sanwa Electric Tester or Kowa Electric Tester for testing.

### Testing Range

Range for the Sanwa Tester: xKΩ  
Range for the Kowa Tester: x100Ω

(+)Probe \ (-)Probe	Peach	Yellow	Red	Green	Black
Peach		∞	4-7K	∞	∞
Yellow	∞		4-7K	∞	∞
Red	∞	∞		∞	∞
Green	4-6K	4-6K	13-17K		1-2K
Black	4-7K	4-7K	13-17K	1-2K	

## A.C. GENERATOR CHARGING COIL

\* The inspection of A.C. generator charging coil can be made with the engine installed.

### INSPECTION

Disconnect the A.C. generator 2P connector. Measure the resistance between the A.C. generator white wire and engine ground with an electric tester.

**Standard:** 0.1 ~ 1.0Ω(at 20°C)

Replace the A.C. generator charging coil if the reading is not within the specifications.

Charging Coil Wire

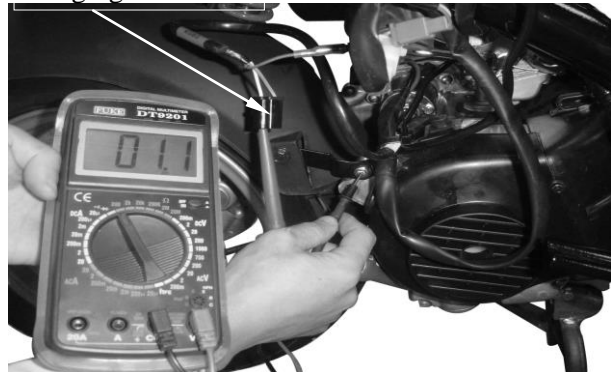

## A.C. GENERATOR

### REMOVAL

Remove the right side cover. (⇒2-4)  
Remove the four bolts attaching the cooling fan cover to remove the fan cover.

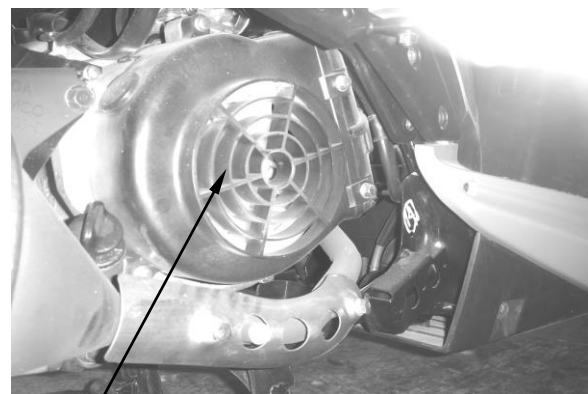

Fan Cover



# 14. BATTERY/CHARGING SYSTEM/ A.C. GENERATOR

Remove the cooling fan by removing the four cooling fan attaching bolts.

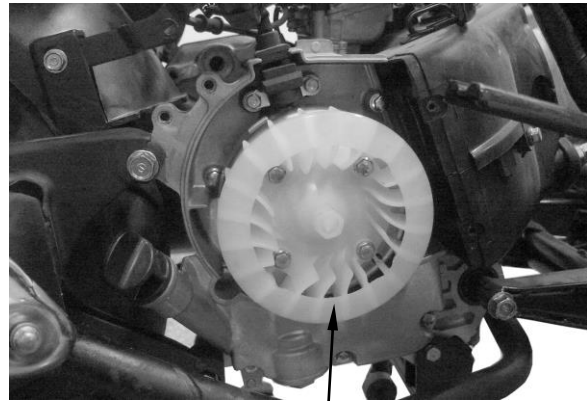

Cooling Fan

Hold the flywheel with an universal holder.  
Remove the flywheel nut.

**Special**

Universal Holder

Universal Holder

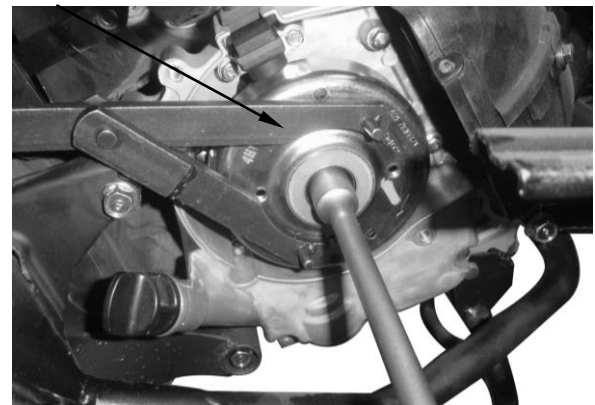

Remove the A.C. generator flywheel using the flywheel puller.  
Remove the woodruff key.

**Special**

Flywheel Puller

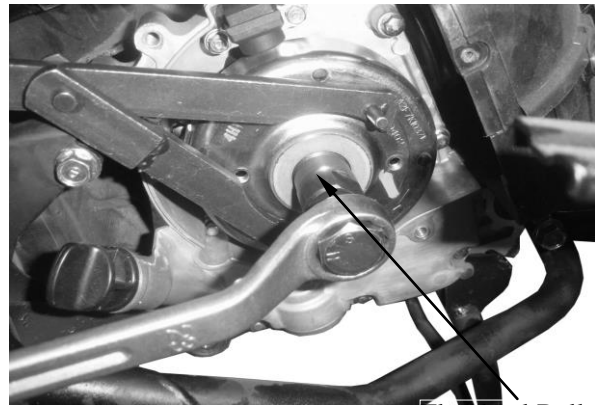

Flywheel Puller

Remove the A.C. generator wire connector.

A.C. Generator Wire Connector



# 14. BATTERY/CHARGING SYSTEM/ A.C. GENERATOR

Remove the A.C. generator wire set plate.  
Remove the pulser coil bolts.  
Remove the A.C. generator wire rubber sleeve and pulser coil from the right crankcase.  
Remove the two bolts and A.C. generator stator.

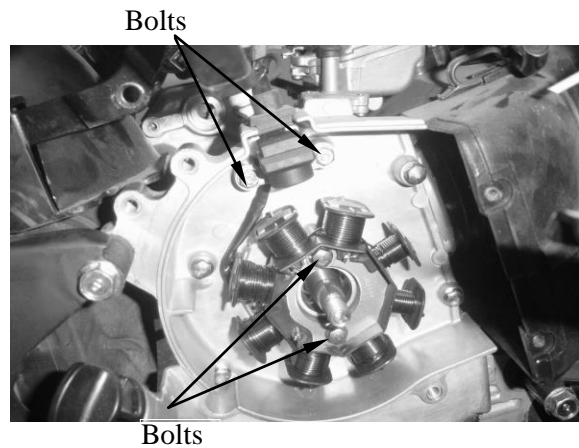

## A.C. GENERATOR INSTALLATION

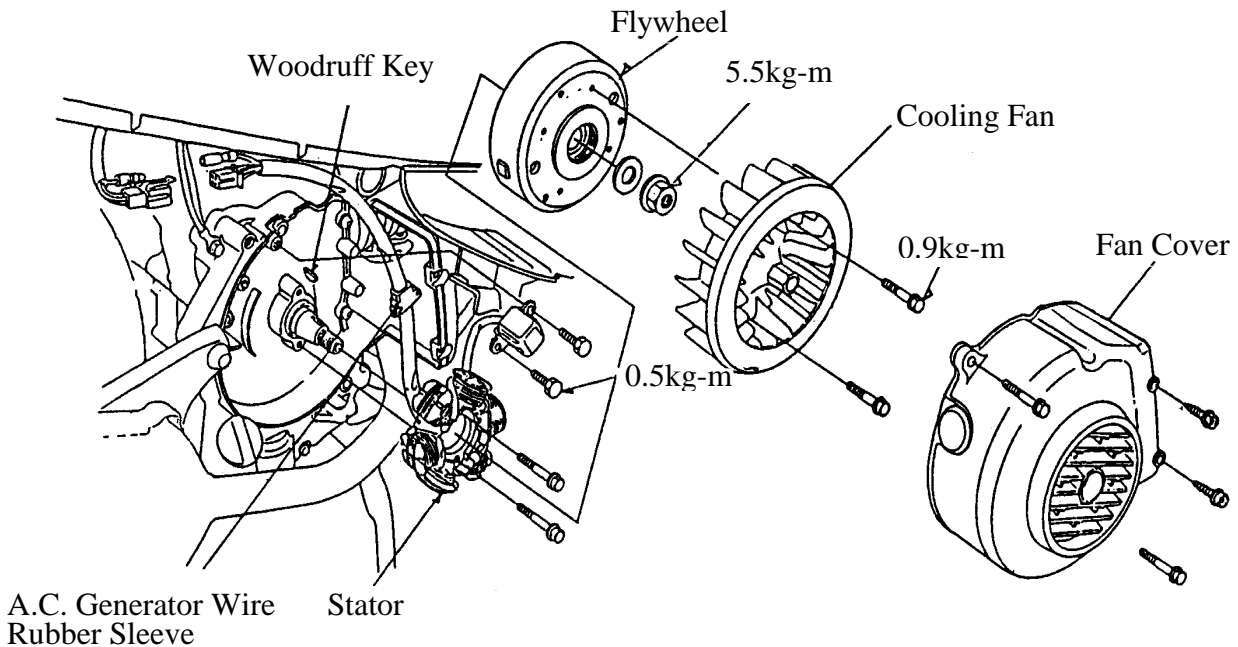

Install the A.C. generator stator and pulser coil onto the right crankcase.  
Tighten the stator and pulser coil bolts.  
**Torques: Pulser Coil : 0.45~0.6kgf-m**  
**Stator : 0.8~1.2kgf-m**

Install the A.C. generator wire rubber sleeve and A.C. generator wire set plate.

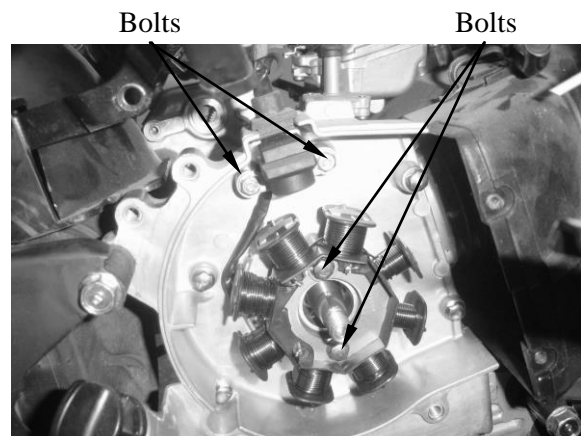

# 14. BATTERY/CHARGING SYSTEM/ A.C. GENERATOR

Connect the A.C. generator wire connector.

A.C. Generator Wire Connector



Clean the taper hole in the flywheel off any burrs and dirt.  
Install the woodruff key in the crankshaft keyway.

Woodruff Key

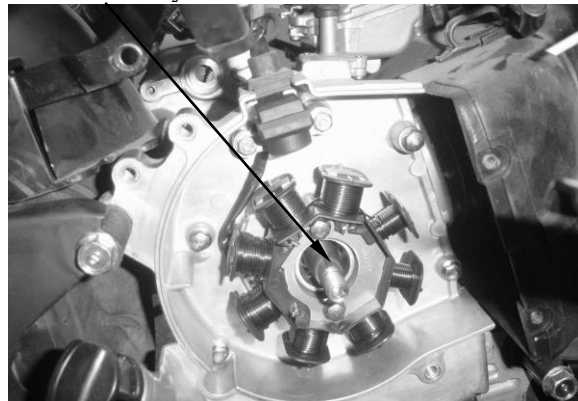

Install the flywheel onto the crankshaft with the flywheel hole aligned with the crankshaft woodruff key.

\* The inside of the flywheel is magnetic.  
Make sure that there is no bolt or nut  
before installation.

Universal Holder

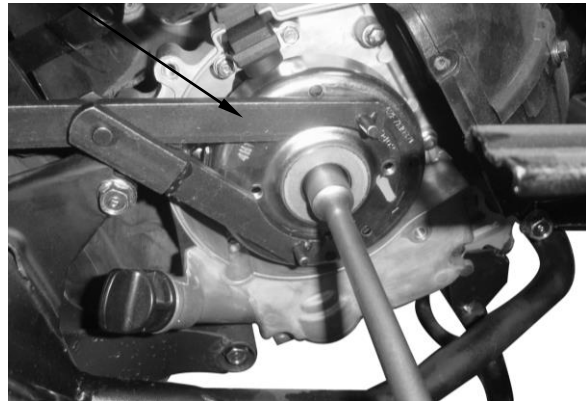

Hold the flywheel with the universal holder and tighten the flywheel nut.

**Torque:** 3.5~4.5kgf-m

Special

Universal Holder

Install the cooling fan.

**Torque:** 0.8~1.2kgf-m

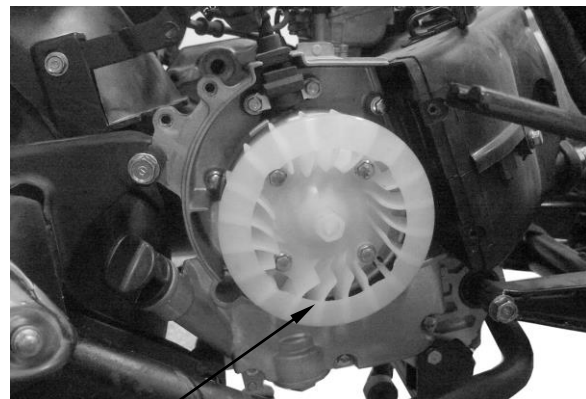

Cooling Fan

## 14. BATTERY/CHARGING SYSTEM/ A.C. GENERATOR

---

Install the fan cover.  
Install the right side cover. (⇒2-4)

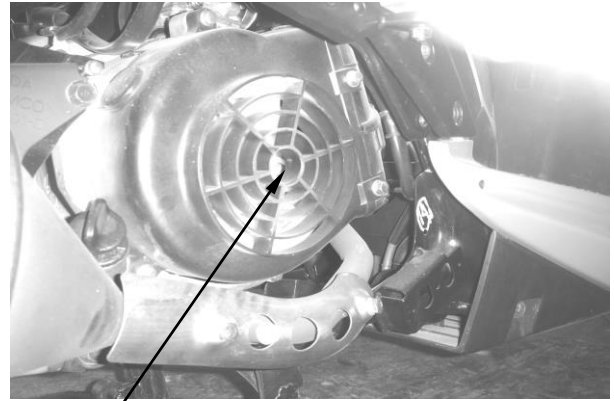

Fan Cover

# 15. IGNITION SYSTEM

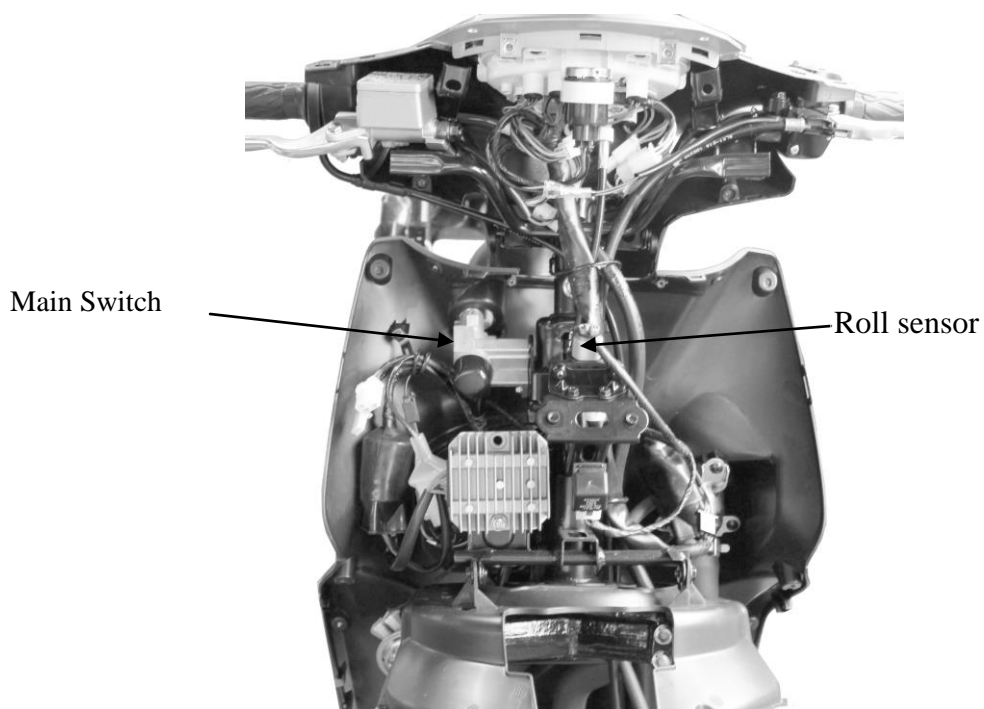
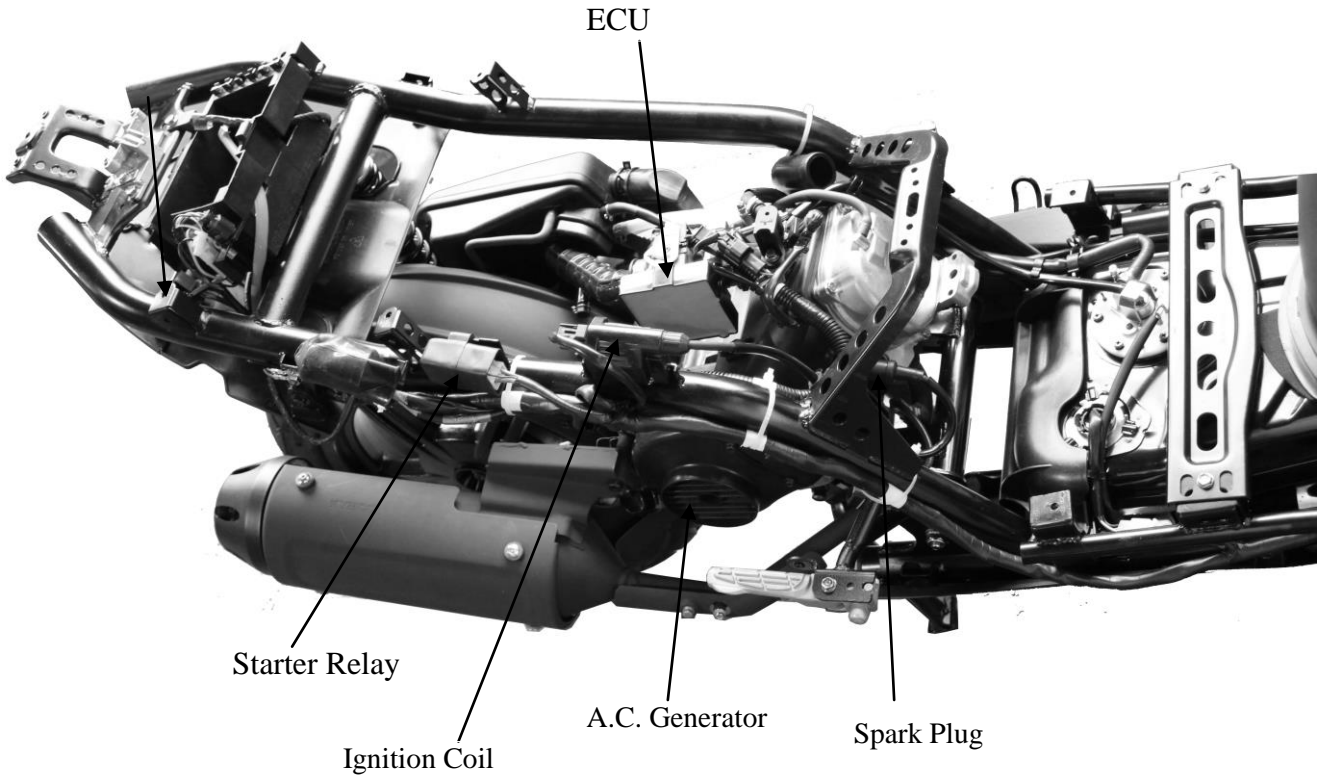

15

### SERVICE INFORMATION

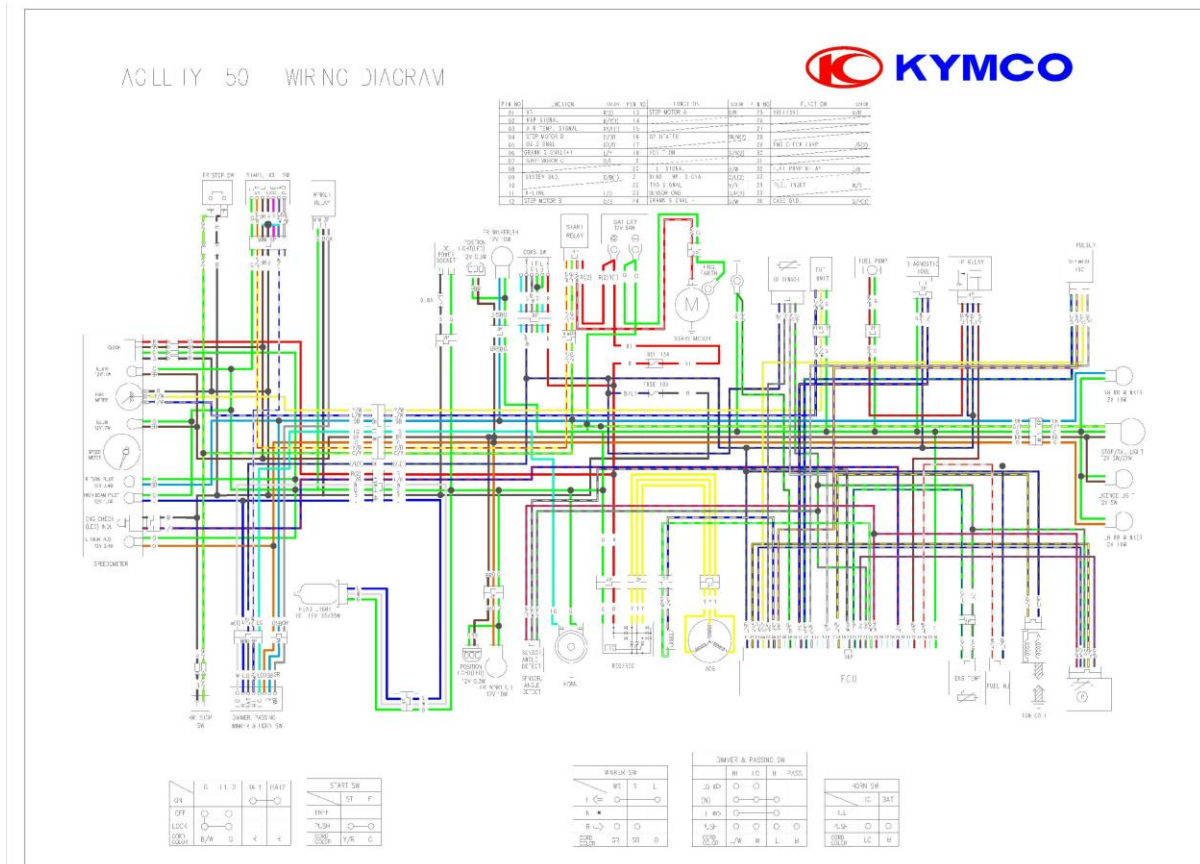

# 15. IGNITION SYSTEM

Super 8 50

## SPECIFICATIONS

Item		Standard
Spark plug	Standard type	NGK CR7HSA
Spark plug gap		0.6 ~ 0.7 mm
Inductive Ignition Coil	Primary coil	0.55~0.75 $\Omega$
Throttle Position Sensor Input Volt		5V $\pm$ 0.1
Fuel Pump		1.0 $\Omega$ ~6.0 $\Omega$
Fuel Injector		10.6 $\Omega$ ~15.9 $\Omega$
Engine Temperature Sensor		2.5k $\Omega$ ~2.7k $\Omega$ (25 $^{\circ}$ C)
Oxygen Sensor ( engine warming condition )		6.7 ~ 9.5 $\Omega$
Crank Position Sensor		96~144 $\Omega$
Angle Detect Sensor		0.4V~1.44V(normal) 3.7V~4.4V (fall down)

## TROUBLESHOOTING

### No peak voltage

- Short circuit in engine stop switch or ignition switch wire.
- Faulty engine stop switch or ignition switch.
- Loose or poorly connected ignition control module connectors.
- Open circuit or poor connection in ground wire of the ignition control module.
- Faulty crank position sensor.
- Faulty ignition control module.

### Peak voltage is normal, but no spark jumps at the plug

- Faulty spark plug or leaking ignition coil secondary current.
- Faulty ignition coil.

# 15. IGNITION SYSTEM

Super 8 50

## IGNITION COIL

### REMOVAL

Remove the met-in box. (⇒2-3)  
 Remove the spark plug cap.  
 Disconnect the ignition coil wires and remove the ignition coil bolt and ignition coil.

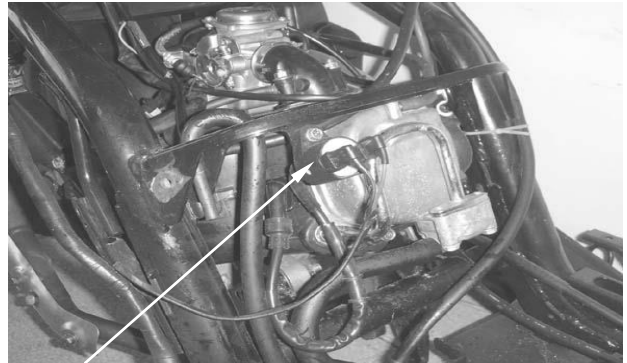

Ignition Coil

### INSPECTION

#### CONTINUITY TEST

Measure the resistance between the ignition coil primary coil terminals.

**Resistance:** 0.1 ~ 1.0Ω

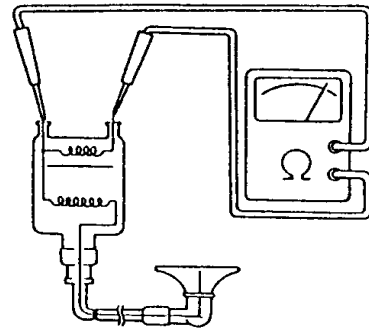

Measure the secondary coil resistances with and without the spark plug cap.

**Resistances:**

(with plug cap) : 7 ~ 12KΩ

(without plug cap) : 3 ~ 5KΩ

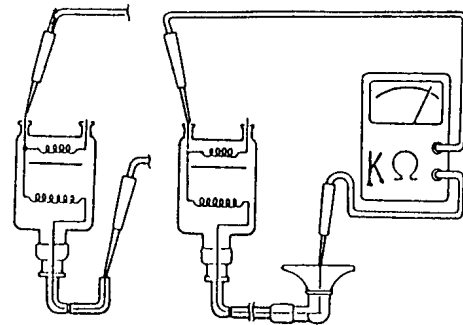

\* Correctly operate the tester following the manufacturer's instructions.



# 15. IGNITION SYSTEM

Super 8 50

## PULSER COIL

### INSPECTION

\* This test is performed with the stator installed in the engine.

Remove the frame body cover. (⇒2-3)  
Disconnect the A.C. generator connector.



Pulser Coil Coupler

Measure the pulser coil resistance between the blue/yellow and green wire terminals.

**Resistance:** 80~160Ω

Refer to page 14-6 for the A.C. generator removal.

## IGNITION TIMING INSPECTION

Remove the timing hole cap.

Timing Hole Cap



Warm up the engine and check the ignition timing with a timing light.  
When the engine is running at the ignition timing is correct if the "F" mark aligns with the index mark within  $\pm 2^\circ$ .

**Ignition Timing:** BTDC $28^\circ$ /4000rpm



"F" Mark

# 15. IGNITION SYSTEM

## A .C. GENERATOR INSPECTION

### CRANK POSITION SENSOR INSPECTION

\* This test is performed with the stator installed in the engine.

Remove the seat and met-in box.  
 Disconnect the Crank Position Sensor Wire Coupler.  
 Measure the resistance between the blue/white and green/white wire terminals.

Blue/Yellow~Green/White	96~144Ω
-------------------------	---------

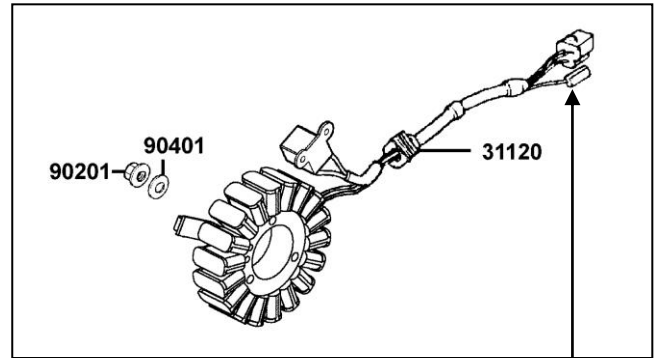

Crank Position Sensor Wire Coupler

## ANGLE DETECT SENSOT

### INSPECTION

Support the scooter level surface.  
 Put the side stand up and engine stop switch is at "RUN".  
 Turn the ignition switch to "OFF".  
 Remove the screws, washers and tilt switch.

\* Do not disconnect the tilt switch connector during inspection.  
 The capacity of battery must be fully charged.

Place the tilt switch vertical as shown at the ignition switch "ON". Measure the voltage as below.

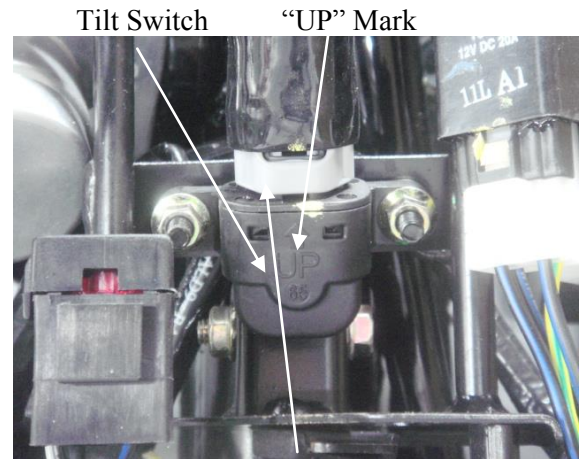

Terminal	Standard
Violet/Red (+) -Violet/Green (-)	5 V (ECU voltage)
Black/White (+) -Violet/Green (-)	0.4~1.44 V less

Incline the tilt switch 65±10 degrees to the left or right at the ignition switch "ON". Measure the voltage as below.

Terminal	Standard
Violet/Red (+) -Violet/Green(-)	5 V (ECU voltage)
Black/White (+) -Violet/Green (-)	3.7~4.4 V

If repeat this test, first turn the ignition switch to "OFF", then turn the ignition switch to "ON".

## **15. IGNITION SYSTEM**

### **REMOVAL/INSTALLATION**

Disconnect the connector and remove two screws, then remove tilt switch.

Installation is in the reverse order of removal.

\* 

Install the tilt switch with its “up” mark facing up.
---

Tighten the mounting screws securely.

# 16. STARTING SYSTEM

Super 8 50

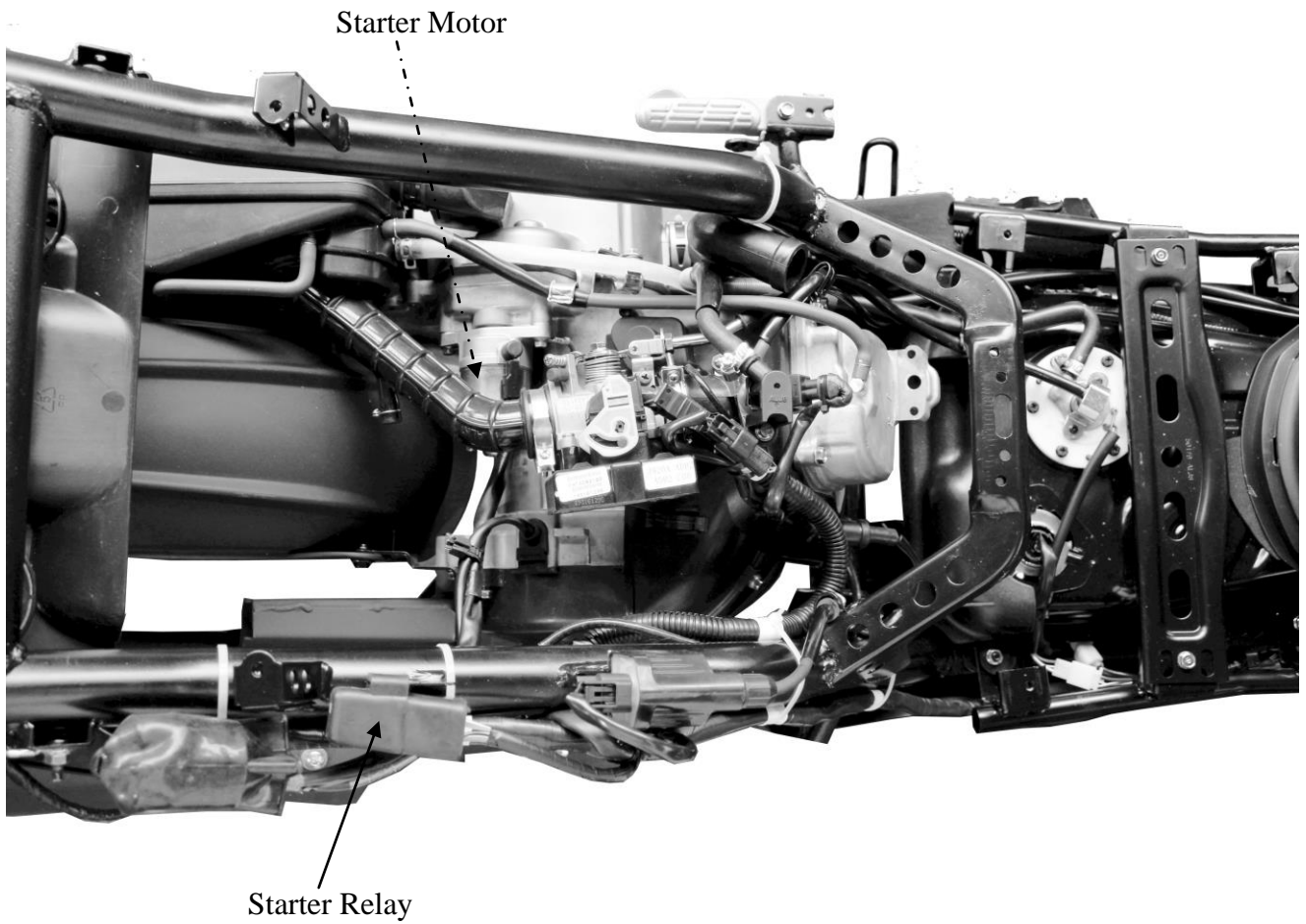

# 16. STARTING SYSTEM

SERVICE INFORMATION .....	16-1	STARTER MOTOR .....	16-2
TROUBLESHOOTING.....	16-1	STARTER RELAY.....	16-4

## SERVICE INFORMATION

### GENERAL INSTRUCTIONS

- The removal of starter motor can be accomplished with the engine installed.

### SPECIFICATIONS

Item	Standard (mm)	Service Limit (mm)
Starter motor brush length	12.5	8.5

### TORQUE VALUES

Starter clutch cover socket bolt	1.2kg-m
Starter clutch lock nut	9.5kg-m

### SPECIAL TOOLS

Flywheel Holder

## TROUBLESHOOTING

### Starter motor won't turn

- Fuse burned out
- Weak battery
- Faulty ignition switch
- Faulty starter clutch
- Faulty front or rear stop switch
- Faulty starter relay
- Poorly connected, broken or shorted wire
- Faulty starter motor

### Lack of power

- Weak battery
- Loose wire or connection
- Foreign matter stuck in starter motor or gear

### Starter motor rotates but engine does not start

- Faulty starter clutch
- Starter motor rotates reversely
- Weak battery

# 16. STARTING SYSTEM

## STARTER MOTOR

### REMOVAL

\* Before removing the starter motor, turn the ignition switch OFF and remove the battery ground. Then, turn on the ignition switch and push the starter button to see if the starter motor operates properly.

Remove the two starter motor mounting bolts and the motor.

Remove the waterproof rubber jacket and disconnect the starter motor cable connector.

### DISASSEMBLY

Remove the two starter motor case screws, front cover, motor case and other parts.

### INSPECTION

Inspect the removed parts for wear, damage or discoloration and replace if necessary. Clean the commutator if there is metal powder between the segments.

Check for continuity between pairs of the commutator segments and there should be continuity. Also, make a continuity check between individual commutator segments and the armature shaft. There should be no continuity.

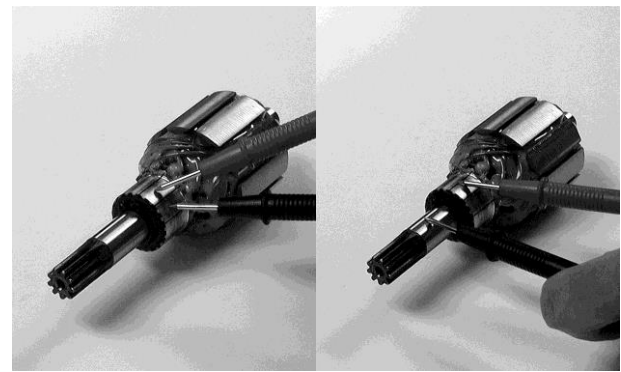
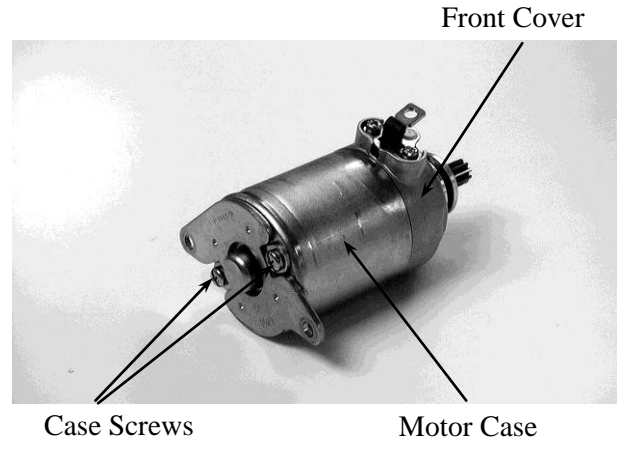
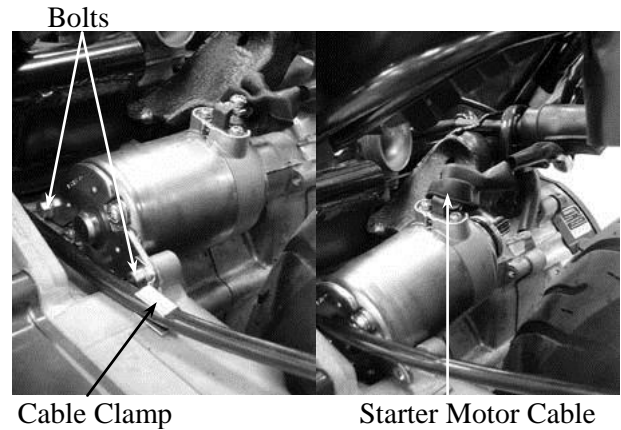

# 16. STARTING SYSTEM

## STARTER MOTOR CASE CONTINUITY CHECK

Check to confirm that there is no continuity between the starter motor wire terminal and the motor front cover.

Also check for the continuity between the wire terminal and each brush.

Replace if necessary.

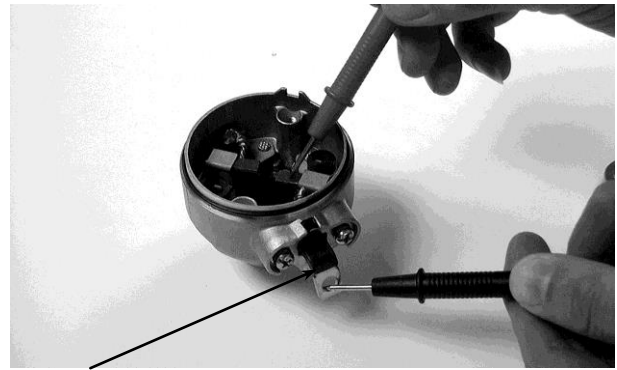

Wire Terminal

Measure the length of the brushes.

**Service Limit:** 8.5mm replace if below



Check for continuity between the brushes. If there is continuity, replace with new ones.



Check if the needle bearing in the front cover turns freely and has no excessive play.

Replace if necessary.

Check the dust seal for wear or damage.

Bearing

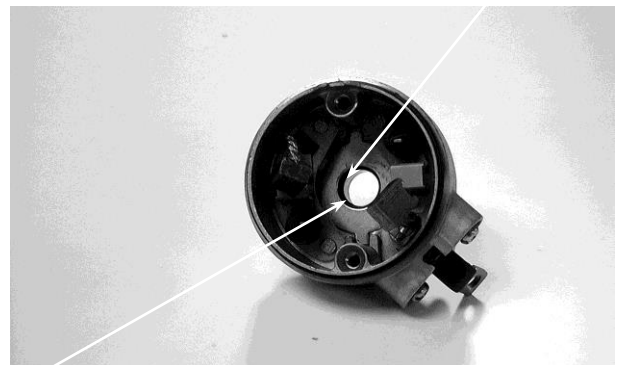

Dust Seal

# 16. STARTING SYSTEM

## ASSEMBLY

Apply grease to the dust seal in the front cover.  
 Install the brushes onto the brush holders.  
 Apply a thin coat of grease to the two ends of the armature shaft.  
 Insert the commutator into the front cover.

- \* • Be careful not to damage the brush and armature shaft mating surfaces.
- When installing the commutator, the armature shaft should not damage the dust seal lip.

Install a new O-ring to the front cover.  
 Install the starter motor case, aligning the tab on the motor case with the groove on the front cover.  
 Tighten the starter motor case screws.

- \* When assembling the front cover and motor case, slightly press down the armature shaft to assemble them.

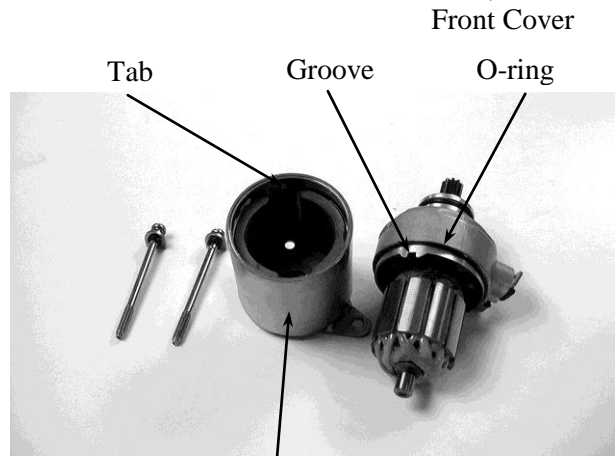
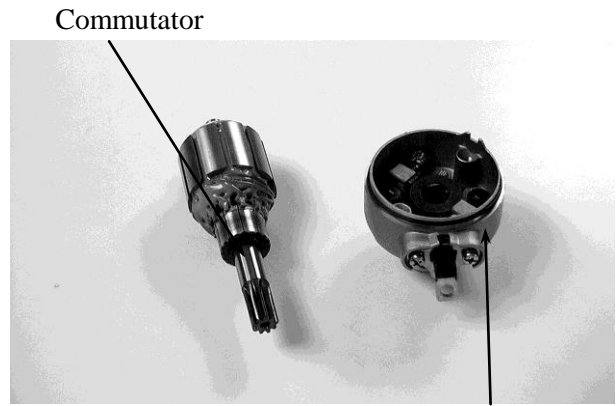

## STARTER RELAY

### INSPECTION

Remove the frame body cover.  
 Turn the ignition switch ON and the starter relay is normal if you hear a click when the starter button is depressed.  
 If there is no click sound:

- Inspect the starter relay voltage
- Inspect the starter relay ground circuit
- Inspect the starter relay operation

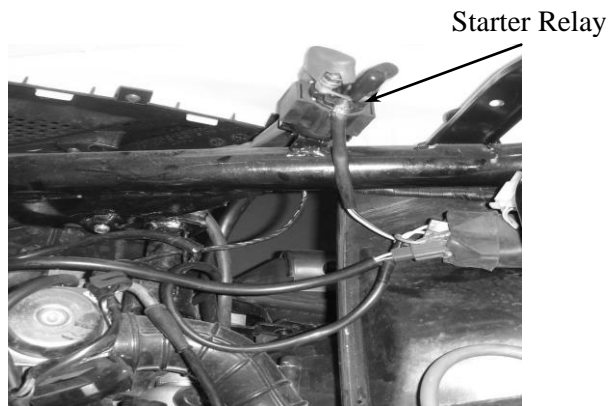

### STARTER RELAY VOLTAGE INSPECTION

Place the motorcycle on its main stand.  
 Measure the voltage between the starter relay connector green/yellow wire (-) and engine ground.  
 Turn the ignition switch ON and the battery voltage should be normal when the brake lever is fully applied.  
 If the battery has no voltage, inspect the stop switch continuity and cable.

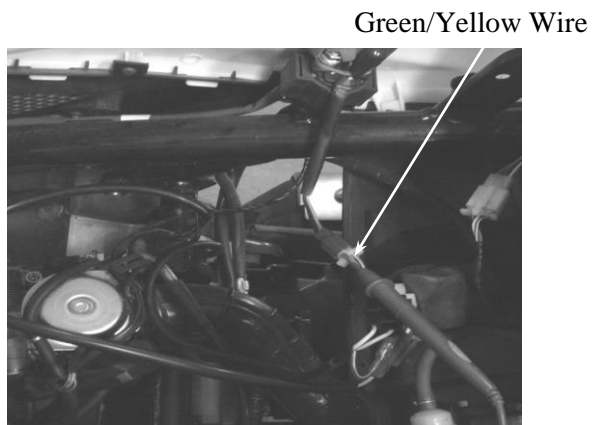



# 16. STARTING SYSTEM

## STARTER RELAY GROUND CIRCUIT INSPECTION

Disconnect the starter relay wire connector. Check for continuity between the yellow/red wire terminal and ground. There should be continuity when the starter button is depressed. If there is no continuity, check the starter button for continuity and inspect the wire.

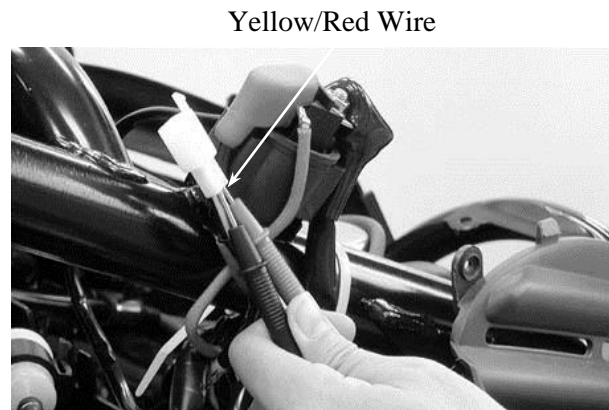

Yellow/Red Wire

## OPERATION TEST

Connect the electric tester to the starter relay larger terminals that connect to the battery positive cable and the starter motor cable. Connect a fully charged battery across the starter relay yellow/red and green/yellow wire terminals. Check for continuity between the starter relay large terminals. The relay is normal if there is continuity.



Starter Relay

## INSTALLATION

Connect the starter motor cable connector and properly install the waterproof rubber jacket. Check the O-ring for wear or damage and replace if necessary. Apply grease to the O-ring and install the starter motor. Tighten the two mounting bolts.

\* The starter motor cable connector must be installed properly.

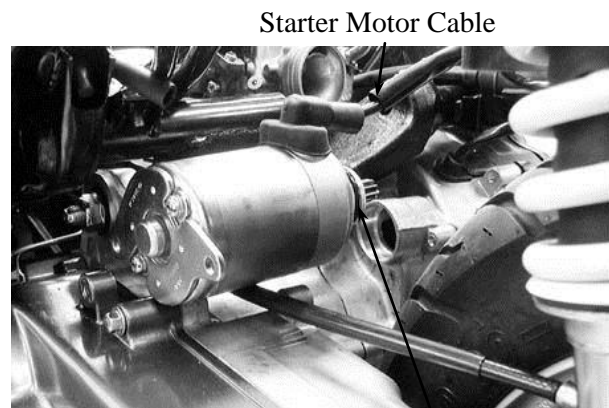

Starter Motor Cable

O-ring

## STARTER CLUTCH

### REMOVAL

Remove the A.C. generator.  
Remove the right crankcase cover.

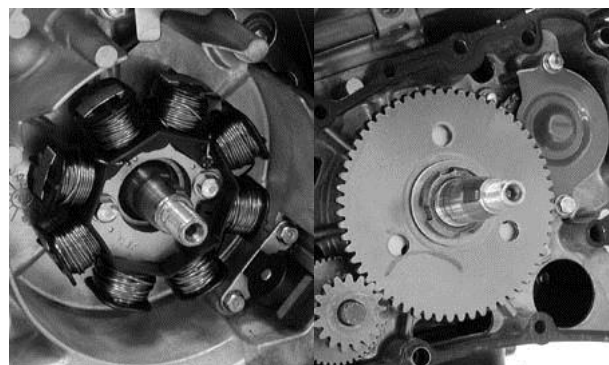

# 16. STARTING SYSTEM

Remove the starter clutch lock nut.

Special

Flywheel Holder

\* Note that the lock nut is left threaded.

Remove the starter clutch.

Remove the starter idle gear and shaft.

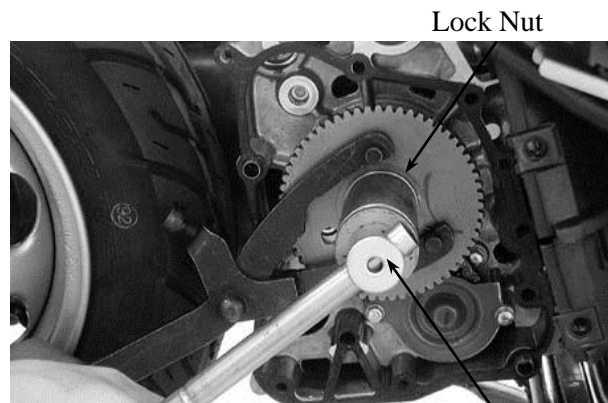

Lock Nut

Flywheel Holder

## INSPECTION

Inspect the operation of the starter drive gear when it is assembled on the clutch.

The starter drive gear should turn clockwise freely and should not turn counterclockwise.

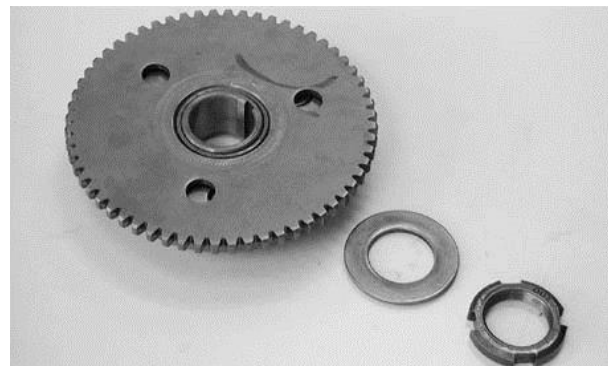

## STARTER CLUTCH DISASSEMBLY

Inspect the starter drive gear for wear or damage and replace if necessary.

Measure the starter drive gear I.D.

**Service Limit:** 32.06mm replace if over

Inspect the needle bearing for wear or damage and replace if necessary.

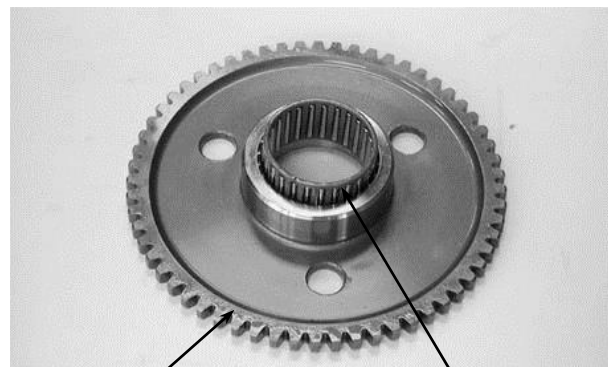

Starter Drive Gear

Needle Bearing

Clutch Body

## CLUTCH BODY DISASSEMBLY

Remove the rollers, plungers and springs from the clutch body.

Inspect the clutch body for wear or damage and replace if necessary.

Inspect each roller and plunger for wear or damage and check for weak spring.

Replace if necessary.

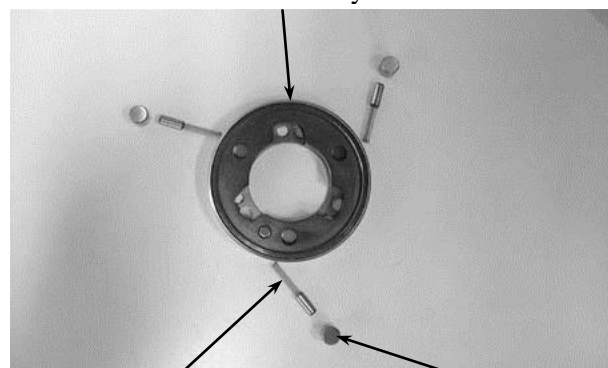

Spring

Roller

# 16. STARTING SYSTEM

Measure the clutch cover O.D.

**Service Limit:** 27.94mm replace if over

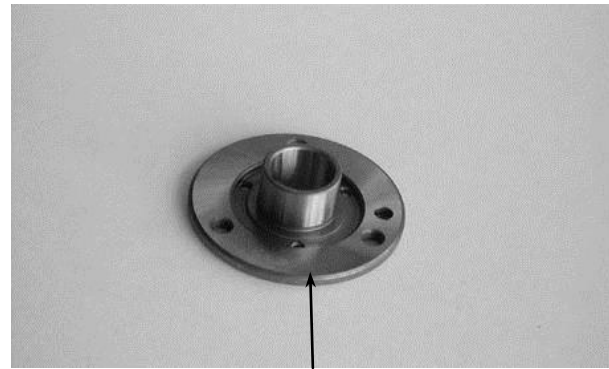

Clutch Cover

Measure the starter idle gear I.D.

**Service Limit:** 10.05mm replace if over

Starter Idle Gear

Measure the starter idle gear shaft O.D.

**Service Limit:** 9.94mm replace if below

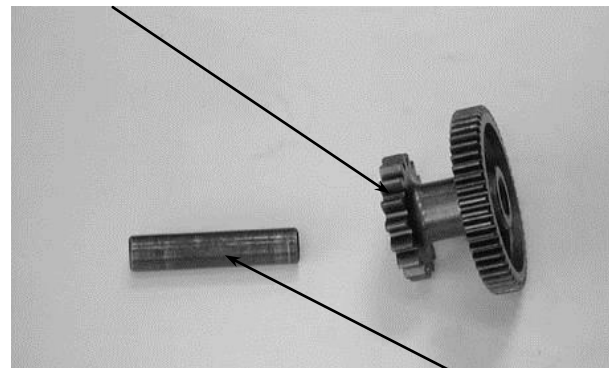

Anchor Pin

Hole

Idle Gear Shaft  
Clutch Cover

## ASSEMBLY

Install the springs, plungers and rollers onto the clutch body.

Install the clutch cover by aligning the clutch cover anchor pin with the hole in the clutch body. Apply locking agent to the threads of the clutch cover bolts and tighten them.

**Torque:** 1.2kg-m

Apply engine oil to the needle bearing and starter drive gear and then install them to the clutch body.

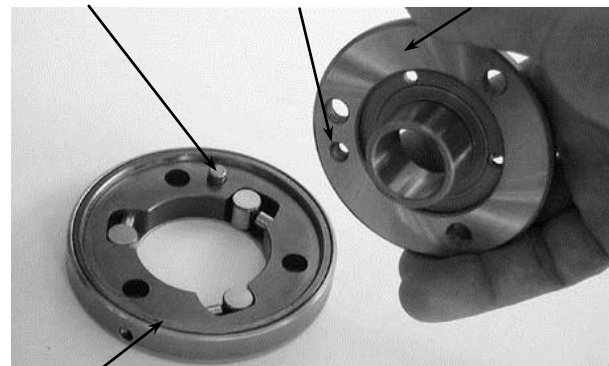

Clutch Body

## INSTALLATION

Install the starter clutch onto the crankshaft. Apply engine oil to the starter idle gear and shaft and then install them.

Hold the starter drive gear with the universal holder and tighten the starter clutch lock nut.

**Torque:** 9.5kg-m

Special

Flywheel Holder

\* Note that the lock nut is left threaded.

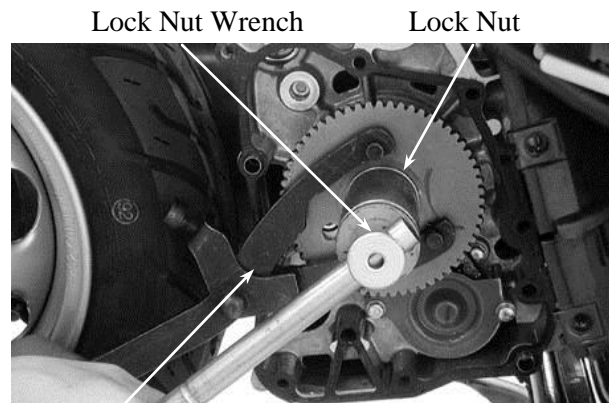

Lock Nut Wrench

Lock Nut

Flywheel Holder

Install the right crankcase cover.

SERVICE INFORMATION .....	17-0	IGNITION SWITCH.....	17-3
TROUBLESHOOTING .....	17-0	STOP SWITCHES/HORN.....	17-4
FUEL UNIT .....	17-1	INSTRUMENTS .....	17-4
HANDLEBAR SWITCHES.....	17-2	HEADLIGHT/LIGHTS.....	17-5

## SERVICE INFORMATION

### GENERAL INSTRUCTIONS

- An electric tester is needed to measure or test the electric equipment.
- Be sure to use fuses and bulbs of the same specifications to avoid damage of electrical equipment.
- After installation of each switch, a continuity check must be performed. A continuity check can usually be made without removing the part from the motorcycle.

## TROUBLESHOOTING

### Lights do not come on when ignition switch is "ON"

- Burned bulb
- Faulty switch
- Broken wire
- Fuse burned out
- Weak battery
- Poorly connected or shorted wire
- Faulty winker

### Light dims

- Faulty ignition coil
- Wire or switch resistance too high
- Faulty regulator/rectifier

### Headlight does not change when dimmer switch is turn to Hi or Lo

- Faulty or burned bulb
- Faulty dimmer switch

### Fuel gauge pointer does not register correctly

- Disconnected wire or connector
- Broken wire
- Faulty float
- Faulty fuel unit
- Faulty instrument

### Fuel gauge pointer fluctuates or swings

- Loose wire connection
- Faulty fuel unit
- Faulty instrument

### FUEL UNIT

\* No Smoking!

#### REMOVAL

Remove the met-in box. (⇒2-3)  
 Remove the frame right side cover. (⇒2-4)  
 Disconnect the fuel unit wire connector.  
 Turn the fuel unit retainer counterclockwise to remove it.

\* Do not damage the fuel unit wire.

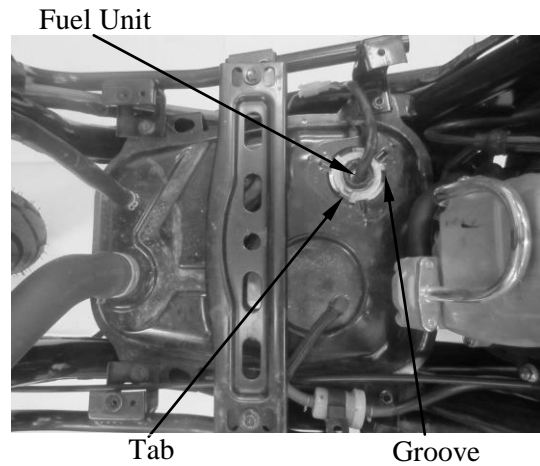

Remove the fuel unit.

\* Be careful not to bend or damage the fuel unit float arm.

#### INSTALLATION

The installation sequence is the reverse of removal.

\* 

- Align the groove on the fuel unit with the tab on the fuel tank.
- Align the arrow on the retainer with the arrow on the fuel tank.
- Turn the retainer clockwise to secure it.

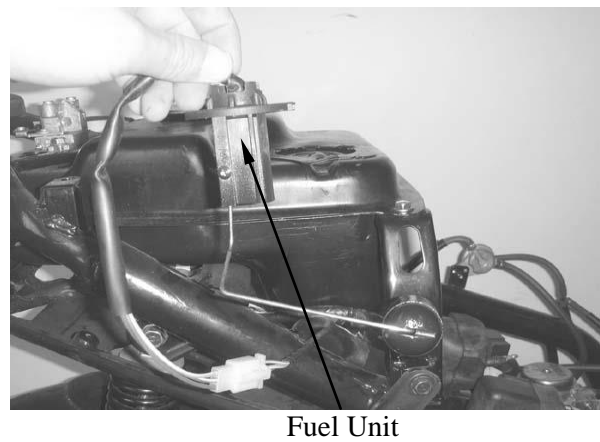

#### INSPECTION

Remove the fuel unit.  
 Measure the resistance between the fuel unit wire terminals with the float at upper and lower positions.

Wire Terminals	Upper	Lower
G~Y/W	30Ω	686Ω
G~L/W	566Ω	153Ω
Y/W~L/W	599Ω	599Ω

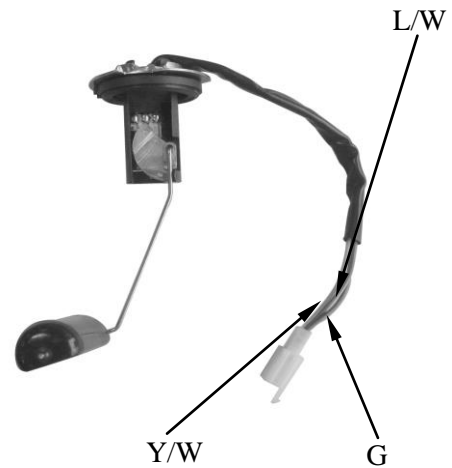

#### FUEL GAUGE INSPECTION

Connect the fuel unit wire connector and turn the ignition switch "ON".

\* Before performing the following test, operate the turn signals to determine that the battery circuit is normal.

Check the fuel gauge needle for correct indication by moving the fuel unit float up and down.

Float Position	Needle Position
Upper	"F" (Full)
Lower	"E" (Empty)

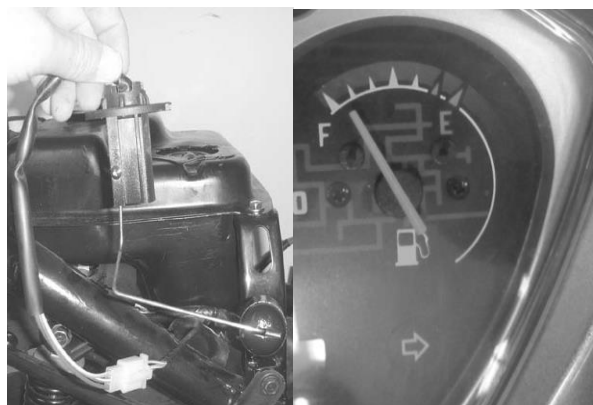

## HANDLEBAR SWITCHES

### INSPECTION

Remove the handlebar front cover. (⇒2-2)  
 Disconnect the handlebar switch couplers and check for continuity between wire terminals.  
 If there is any abnormality found, check each switch.

### HEADLIGHT SWITCH

Color	Black	Brown	Blue/White	Brown/White
•	○			
	○	○	○	○
	○	○	○	

\* Use the X1Ω range for test when using an electric tester.

### STARTER SWITCH

Color	Yellow/Red	Green
FREE		
PUSH	○	○

### DIMMER SWITCH

Color	White	Black	Blue
	○	○	
		○	○

### TURN SIGNAL SWITCH

Color	Gray	Light Blue	Orange
R	○	○	
N			
L	○		○

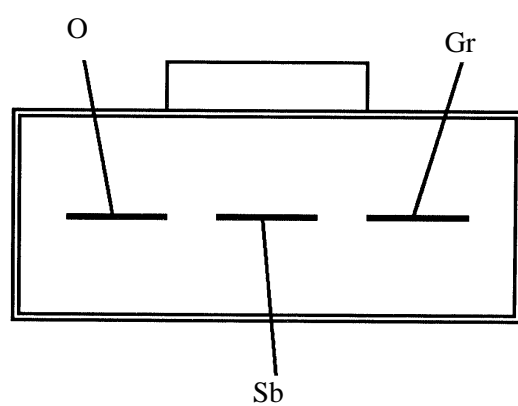
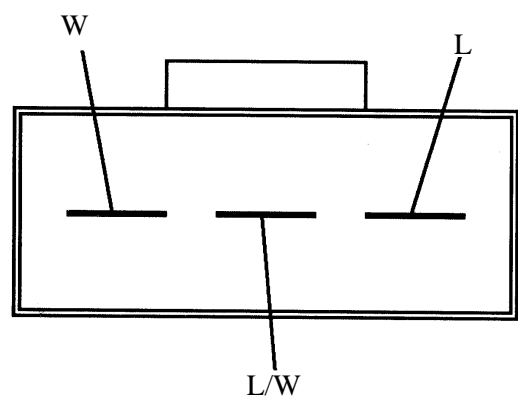
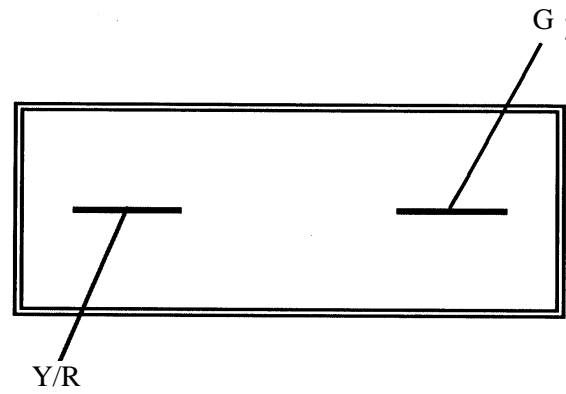
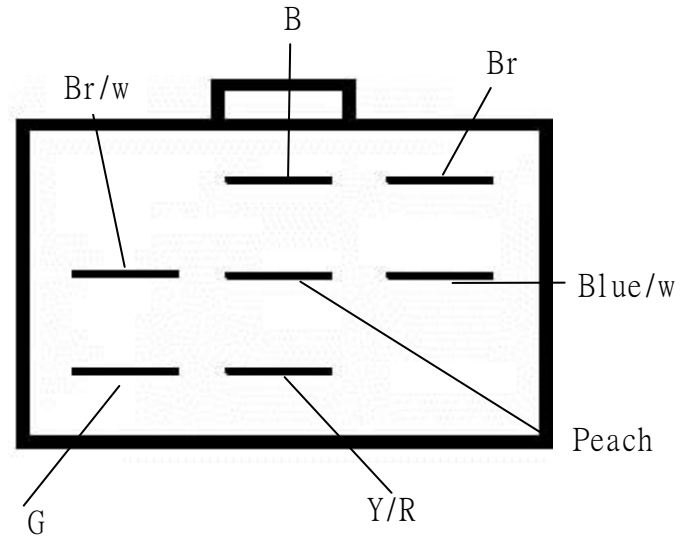

# 17. LIGHTS/INSTRUMENTS/SWITCHES

## HORN SWITCH

Color	Light Green	Black
FREE		
PUSH		

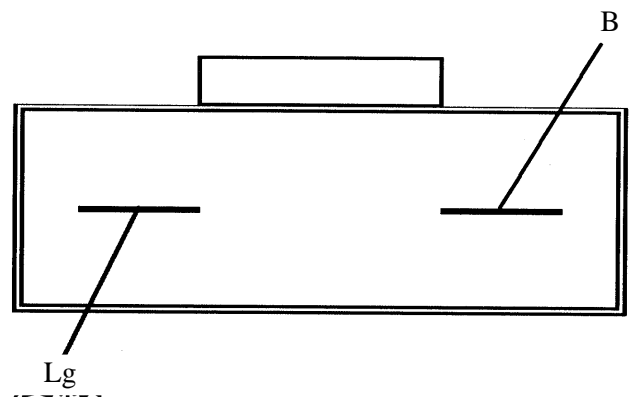

## SWITCH REPLACEMENT

Remove the front covers. (⇒2-2)  
 Remove the handlebar front cover. (⇒2-2)  
 The installation sequence is the reverse of removal.

## IGNITION SWITCH

### INSPECTION

Remove the front covers. (⇒2-2)  
 Disconnect the ignition switch wire coupler.  
 Check for continuity between the wire terminals.

Color	Black	Red	Black/Blue	Green
OFF				
ON				
LOCK				

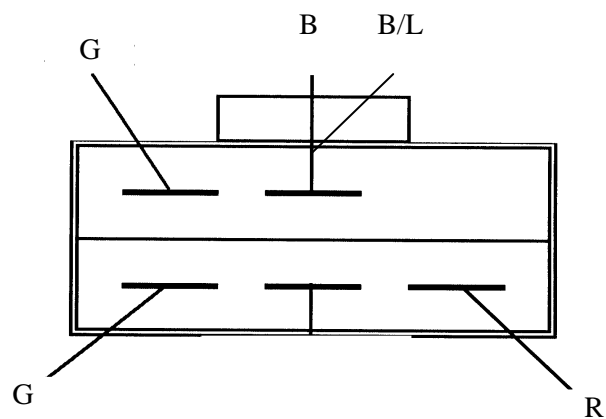

## IGNITION SWITCH REPLACEMENT

Remove the front covers. (⇒2-2)  
 Disconnect the ignition switch wire coupler.  
 Remove the two mounting bolts to remove the ignition switch decorative ring and holder.  
 Remove the two screws to remove the ignition switch from the ignition switch holder for replacement.  
 The installation sequence is the reverse of removal.

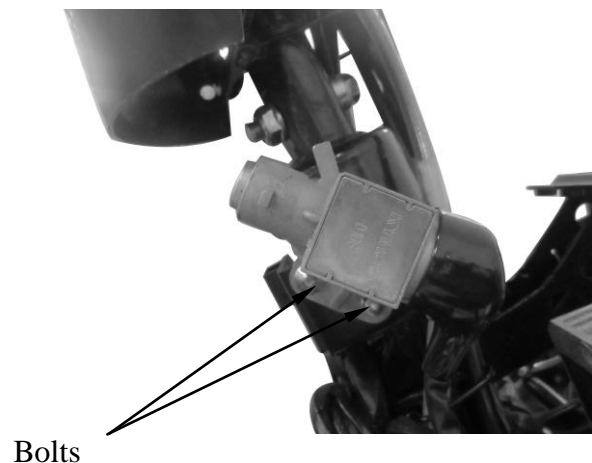

## STOP SWITCH

### INSPECTION

Remove the handlebar front cover. (⇒2-2)  
 Disconnect the front stop switch wire coupler.  
 Check for continuity between the wire terminals when the front brake lever is applied. The switch is normal if there is continuity.  
 Disconnect the rear stop switch wire coupler.  
 Check for continuity between the wire terminals when the rear brake lever is applied. The switch is normal if there is continuity.



Stop Switch Wire

## HORN

### INSPECTION

Remove the front covers. (⇒2-2)  
 Disconnect the horn wire coupler.  
 The horn is normal if it sounds when a 12V battery is connected across the horn wire terminals.

### REPLACEMENT

Disconnect the horn wire coupler.  
 Remove the two bolts attaching the horn.  
 Remove the horn.  
 The installation sequence is the reverse of removal.

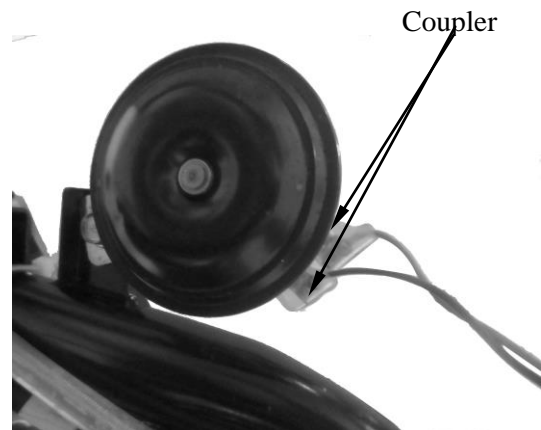

## INSTRUMENTS

Remove the handlebar front cover. (⇒2-2)  
 Remove the handlebar rear cover. (⇒2-2)  
 Disconnect the handlebar switch couplers.  
 Remove the three screws to remove the instruments.  
 Install a new horn in the reverse order of removal.

Instruments

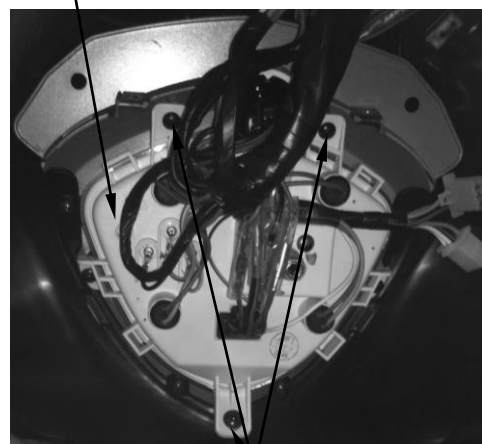

Screws



### HEADLIGHT REMOVAL

Remove the screw on the front cover.  
Remove the two screws on the back of the front cover.  
Remove the front cover.

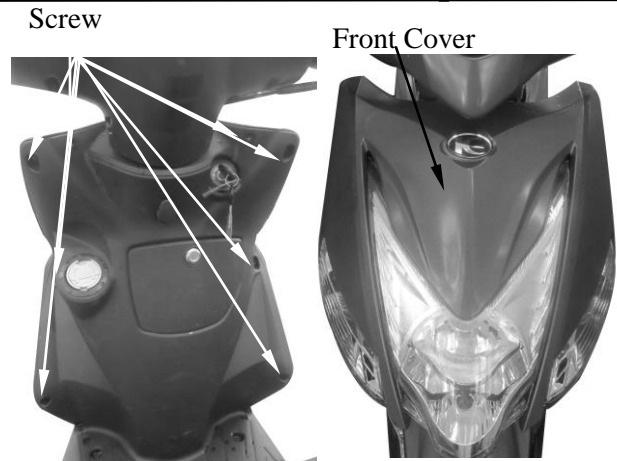

The installation sequence is the reverse of removal.

- \* 
  - Align the tab on the headlight with the groove on the handlebar cover.
  - After installation, adjust the headlight beam. (⇒3-9)

### BULB REPLACEMENT

Remove the headlight bulb Coupler. (⇒2-2)  
Remove the headlight replace with new bulbs.  
The installation sequence is the reverse of removal.

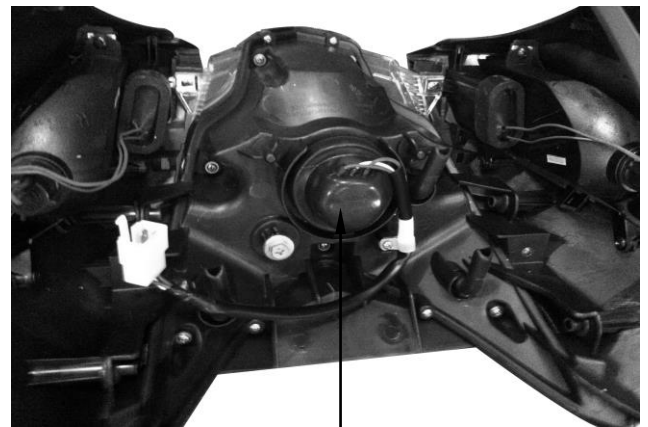

Headlight Bulb Coupler