

TABLE OF CONTENTS

SPECIFICATIONS.....	1
GENERAL INFORMATION	2
INSPECTION/ADJUSTMENT	3
LUBRICATION SYSTEM	4
ENGINE REMOVAL/INSTALLATION.....	5
CYLINDER HEAD/CYLINDER/PISTON.....	6
A.C. GENERATOR.....	7
KICK STARTER/DRIVE PULLEY/CLUTCH/DRIVEN PULLEY.....	8
FINAL REDUCTION.....	9
CRANKCASE/CRANKSHAFT	10
CARBURETOR	11
FRAME COVERS.....	12
STEERING HANDLEBAR/FRONT WHEEL/FRONT BRAKE/ FRONT SHOCK ABSORBER/FRONT FORK	13
REAR WHEEL/REAR BRAKE/REAR SHOCK ABSORBER	14
ELECTRICAL EQUIPMENT.....	15
INSTRUMENT/SWITCHES/LIGHTS	16
EXHAUST EMISSION CONTROL SYSTEM.....	17

1.SPECIFICATIONS

SUPER8 50 2T

SPECIFICATIONS

Name & Model		SUPER8 50 2T	
Overall length (mm)		2040	
Overall width (mm)		745	
Overall height (mm)		1240	
Wheel base (mm)		1350	
Engine type		Air cooled 2-stroke	
Fuel Used		92# nonleaded	
Displacement (cc)		49.5 cc	
Net weight (kg)	Front wheel	44	
	Rear wheel	63.5	
	Total	107.5	
Gross weight(kg)	Front wheel	44	
	Rear wheel	68	
	Total	112	
Tires	Front wheel	120/70-14 50P	
	Rear wheel	120/80-14 52P	
Ground clearance (mm)		120	
Braking distance (m) (Initial speed Km/h)		4m (30km/h)	
Min. turning radius (mm)R/L		2000/2000	
Starting system		Starting motor & kick starter	
Fuel type		Gasoline, 2-stroke motor oil	
Cylinder arrangement		Single cylinder, flat	
Combustion chamber type		Semi-sphere	
Valve arrangement		Reed valve & piston	
Bore x stroke (mm)		39 x 41.4	
Compression ratio		7.2:1 ±0.2	
Compression pressure (kg/cm ² rpm)		11.8kg/cm ² ±2	
Max. output (ps/r/min)		2.6/6500	
Speed limit/No limit		2.8/6500	
Max. torque (kg m/rpm)		0.42/6000 kg m/rpm	
Port timing	Intake	Open	Automatic controlled
		Close	Automatic controlled
	Exhaust	Open	—
		Close	—
	Scaveng e	Open	—
		Close	—
Idle speed (rpm)		1850±100	
Lubrication type		Separate type	
Oil pump type		Plunger type	
Oil filter type		Full-flow filtration	

Lubrication oil capacity (liter)		1.1	
Air cleaner type & No.		Wet, single	
Fuel capacity (liter)		6.0	
Carburetor	Type	Plunger type	
	Piston dia. (mm)	—	
	Venturi dia. (mm)	16	
Ignition system type		CDI electromagnetic Ignition	
Ignition timing F mark		13.5°±1°BTDC/2000 rpm	
Spark plug		NGK	BR8HSA
Spark plug gap (mm)		0.6~0.7	
Battery capacity		12V6AH	
Power to transmission gear		Power-transmission gear-clutch	
Reduction ratio of power to transmission		—	
Clutch type		Dry multi-disc clutch	
Transmission gear operation type		Automatic centrifugal type	
Transmission ratio		1 speed	—
Reduction gear	Type	Two-stage reduction	
	1st reduction ratio	3.113~0.895	
	2nd reduction ratio	14.69	
Transmission gear type		Non-stage	
Tire pressure (kg/cm ²)	Front wheel	1.75 kg/cm ²	
	Rear wheel	2.25 kg/cm ²	
Turning angle		Right & left 45°	
Brake system type	Front wheel	hydraulic	
	Rear wheel	Expanding	
Suspension type	Front wheel	Telescope	
	Rear wheel	Unit swing	
Shock absorber type	Front wheel	Telescope	
	Rear wheel	Unit swing	
Frame type		Pipe under bone	

GENERAL INFORMATION

ENGINE SERIAL NUMBER/IDENTIFICATION 2- 1

SERVICE PRECAUTIONS 2- 2

SERVICE INFORMATION 2- 10

TORQUE VALUES 2- 12

SPECIAL TOOLS 2- 13

LUBRICATION POINTS 2- 15

WIRING DIAGRAM..... 2- 16

CABLE & HARNESS ROUTING..... 2- 17

TROUBLESHOOTING..... 2- 21

ENGINE SERIAL NUMBER/IDENTIFICATION



Location of Engine Serial Number

SERVICE PRECAUTIONS

- Make sure to install new gaskets, O-rings, circlips, cotter pins, etc. when reassembling.

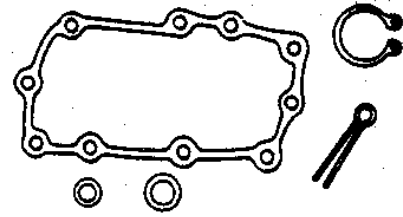

- When tightening bolts or nuts, begin with larger-diameter to smaller ones at several times, and tighten to the specified torque diagonally.

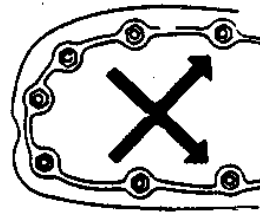

- Use genuine parts and lubricants.

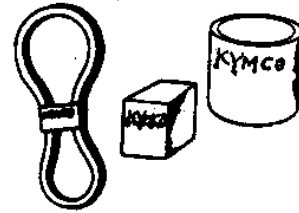

- When servicing the motorcycle, be sure to use special tools for removal and installation.



- After disassembly, clean removed parts. Lubricate sliding surfaces with engine oil before reassembly.

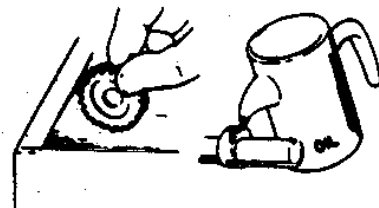

- Apply or add designated greases and lubricants to the specified lubrication points.

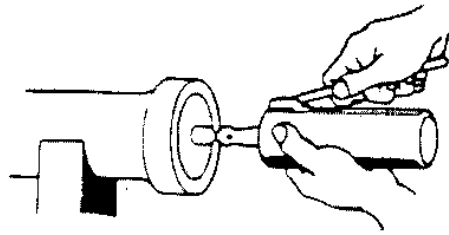

- After reassembly, check all parts for proper tightening and operation.

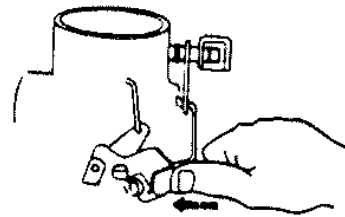

- When two persons work together, pay attention to the mutual working safety.

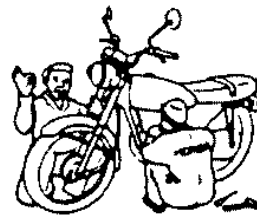

- Disconnect the battery negative (-) terminal before operation.
- When using a spanner or other tools, make sure not to damage the motorcycle surface.

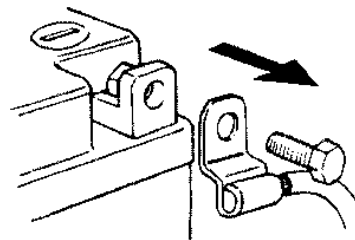

- After operation, check all connecting points, fasteners, and lines for proper connection and installation.
- When connecting the battery, the positive (+) terminal must be connected first.
- After connection, apply grease to the battery terminals.
- Terminal caps shall be installed securely.

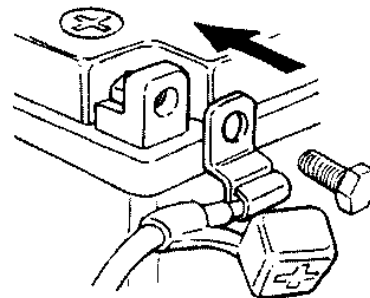

- If the fuse is burned out, find the cause and repair it. Replace it with a new one according to the specified capacity.

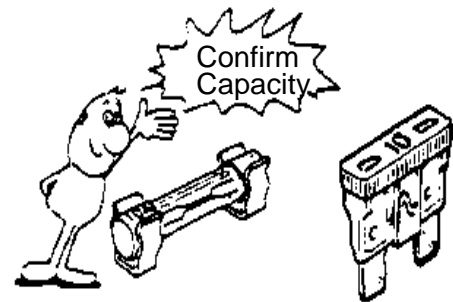

- After operation, terminal caps shall be installed securely.



- When taking out the connector, the lock on the connector shall be released before operation.

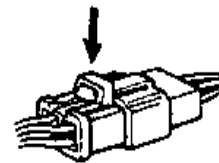

- Hold the connector body when connecting or disconnecting it.
- Do not pull the connector wire.

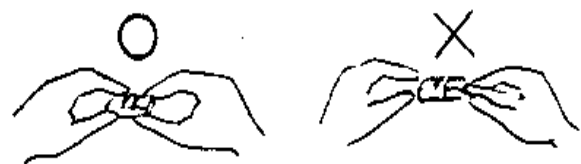

- Check if any connector terminal is bending, protruding or loose.

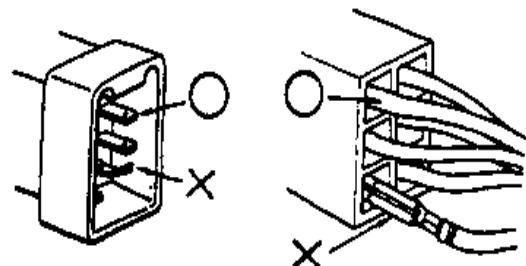

- The connector shall be inserted completely.
- If the double connector has a lock, lock it at the correct position.
- Check if there is any loose wire.

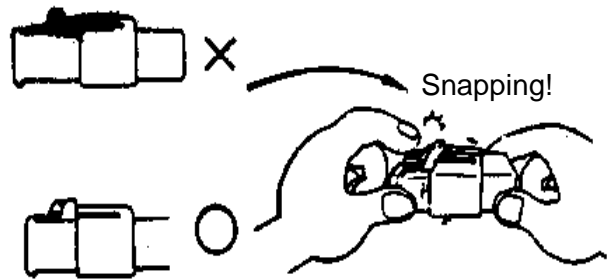

- Before connecting a terminal, check for damaged terminal cover or loose negative terminal.

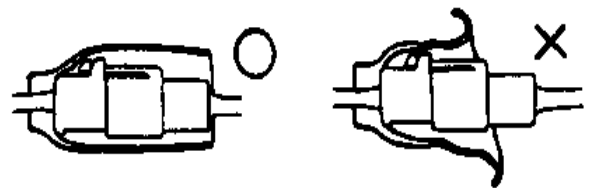

- Check the double connector cover for proper coverage and installation.

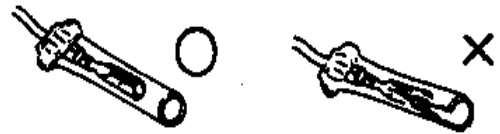

- Insert the terminal completely.
- Check the terminal cover for proper coverage.
- Do not make the terminal cover opening face up.



- Secure wire harnesses to the frame with their respective wire bands at the designated locations. Tighten the bands so that only the insulated surfaces contact the wire harnesses.

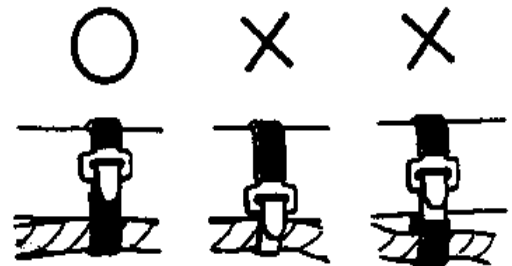

- After clamping, check each wire to make sure it is secure.

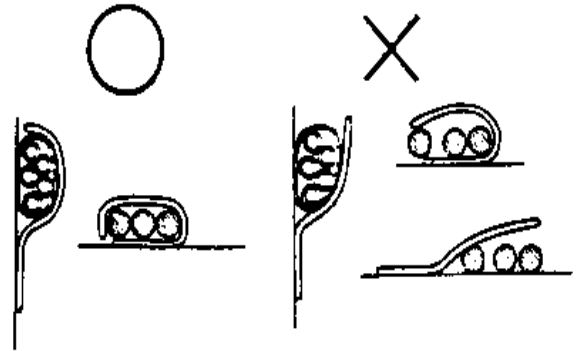

- Do not squeeze wires against the weld or its clamp.

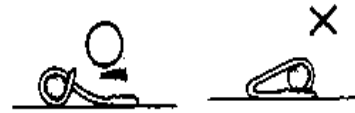

- After clamping, check each harness to make sure that it is not interfering with any moving or sliding parts.

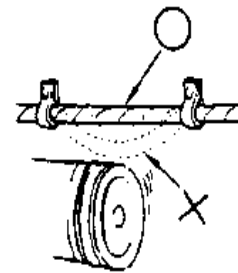

- When fixing the wire harnesses, do not make it contact the parts which will generate high heat.

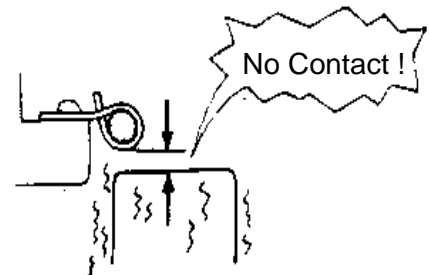

- Route wire harnesses to avoid sharp edges or corners. Avoid the projected ends of bolts and screws.
- Route wire harnesses passing through the side of bolts and screws. Avoid the projected ends of bolts and screws.

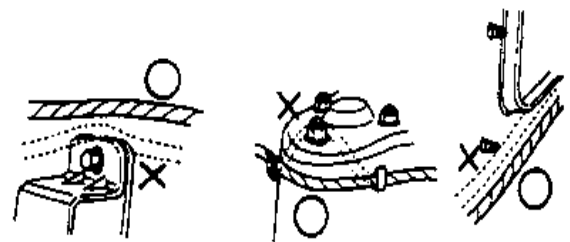

- Route harnesses so they are neither pulled tight nor have excessive slack.

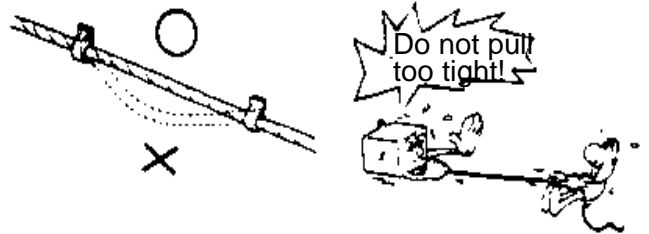

- Protect wires and harnesses with electrical tape or tube if they contact a sharp edge or corner.

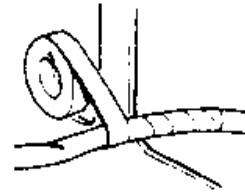

- When rubber protecting cover is used to protect the wire harnesses, it shall be installed securely.

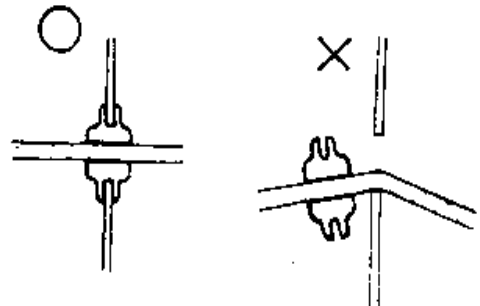

- Do not break the sheath of wire.
- If a wire or harness is with a broken sheath, repair by wrapping it with protective tape or replace it.

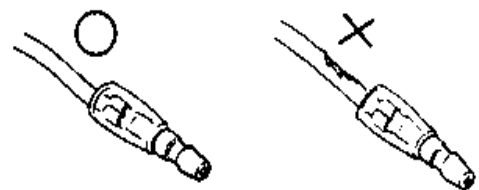

- When installing other parts, do not press or squeeze the wires.

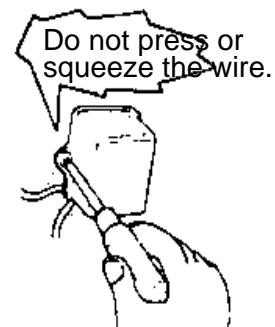

- After routing, check that the wire harnesses are not twisted or kinked.

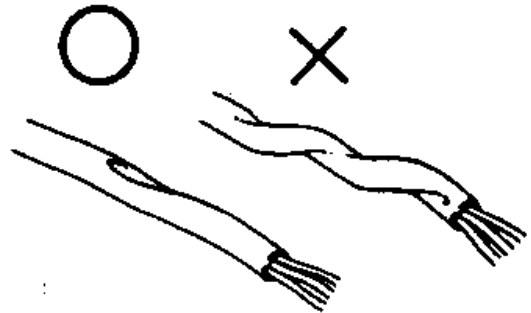

- Wire harnesses routed along with handlebar should not be pulled tight, have excessive slack or interfere with adjacent or surrounding parts in all steering positions.

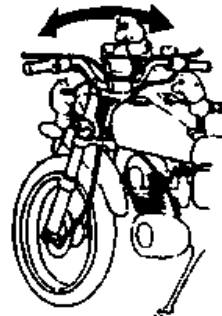

- When a testing device is used, make sure to understand the operating methods thoroughly and operate according to the operating instructions.

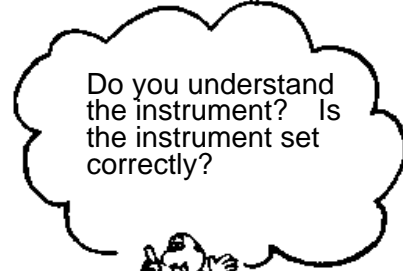

- Be careful not to drop any parts.



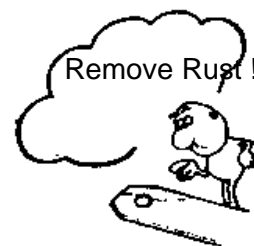

- When rust is found on a terminal, remove the rust with sand paper or equivalent before connecting.



■ Symbols:

The following symbols represent the servicing methods and cautions included in this service manual.

Engine Oil : Apply engine oil to the specified points. (Use designated engine oil for lubrication.)

Grease : Apply grease for lubrication.

Special : Use special tool.

* : Caution

 : Warning

2. GENERAL INFORMATION

SUPER8 50 2T

SERVICE INFORMATION

ENGINE Item	Standard (mm)	Service Limit (mm)
	SUPER8 50 2T	SUPER8 50 2T
Cylinder head warp	—	0.10
Piston O.D.(5mm from bottom of piston skirt)	38.970~38.955	38.90
Cylinder-to- piston clearance		0.10
Piston pin hole I.D.	12.002~12.008	12.03
Piston pin O.D.	11.994~12.0	11.98
Piston-to-piston pin clearance	←	←
Piston ring end gap (top/second)	0.10~0.25	0.40
Connecting rod small end I.D.	17.005~17.017	17.03
Cylinder bore	39.0~39.025	39.05
Drive belt width	18	17
Drive pulley collar O.D.	20.01~20.025	←
Movable drive face I.D.	20.035~20.085	19.97
Weight roller O.D.	13.0	12.4
Clutch outer I.D.	107~107.2	107.5
Driven face spring free length	87.9	82.6
Driven face O.D.	←	←
Movable driven face I.D.	←	←
Connecting rod big end side clearance	←	←
Connecting rod big end radial clearance	←	←
Crankshaft runout A/B	—	←

CARBURETOR

	SUPER8 50 2T
Venturi dia.	16mm
Identification number	PB
Float level	8.6mm
Main jet	#72
Slow jet	#35
Air screw opening	1¼ ± ½
Idle speed	1950±100rpm
Throttle grip free play	2~6mm
Jet needle clip notch	1st notch

2. GENERAL INFORMATION

SUPER8 50 2T

FRAME		Standard (mm)	Service Limit (mm)
Item		SUPER8 50 2T	SUPER8 50 2T
Axle shaft runout		—	0.2
Front wheel rim runout	Radial		
	Axial		
Front shock absorber spring free length		200.0	182.8
Rear wheel rim runout			2.0
Brake drum I.D.	Front/rear	110	111
Brake lining thickness	Front/rear	5.7/4.0	2.0/2.0
Brake disk runout	Front/rear	—	0.30
Rear shock absorber spring free length		235.7	218.7

ELECTRICAL EQUIPMENT			SUPER8 50 2T
Battery	Capacity		12V6AH
	Voltage		13.0~13.2V
	Charging current	Standard	0.4A/5H
		Quick	4A/0.5H
Spark plug	(NGK)		BR8HSA
Spark plug gap			0.6~0.7mm
Ignition coil resistance	Primary coil		0.153~0.187Ω
	Secondary coil (with plug cap)		6.99~10.21KΩ
	Secondary coil (without plug cap)		3.24~3.96KΩ
Pulser coil resistance (20°C)			80~160Ω
Ignition timing			13°±1°BTDC/2000rpm

TORQUE VALUES

ENGINE

Item	Thread dia. (mm)	Torque (kg-m)	Remarks
Cylinder head bolt	BF7x115	1.5~1.7	(cold)
Clutch drive plate nut	10	3.5~4.0	
Clutch outer nut	NH10	3.5~4.5	
Drive face nut	NH12	5.0~6.0	
Oil check bolt	10	1.0~1.5	
Engine mounting bolt	BF10x95	4.5~5.5	
Engine hanger bracket bolt	BF10x50	3.5~4.5	
Exhaust muffler joint lock nut	M8mm	1.8~2.2	
Exhaust muffler lock bolt	BF8x35	3.0~3.6	
Spark plug		1.1~1.7	(cold)

FRAME

Item	Thread dia. (mm)	Torque (kg-m)	Remarks
Handlebar lock nut	10	4.5~5.0	Flange bolt/U-nut
Steering stem lock nut	25.4	7.0~8.0	
Steering top cone race	25.4	0.5~1.3	
Front axle nut	12	5.0~7.0	Flange U-nut
Rear axle nut	16	11.0~13.0	Flange U-nut
Rear brake arm bolt			Flange nut
Front shock absorber:			
upper mount bolt	8	2.4~3.0	Flange bolt/U-nut
lower mount bolt			Cross head
hex bolt		1.5~3.0	Apply locking agent
Front damper nut	8	1.5~3.0	
Front pivot arm bolt			Flange screw/U-nut
Rear shock absorber:			
upper mount bolt	10	3.5~4.5	Flange nut
lower mount bolt	8	2.4~3.0	
lower joint nut	8	1.8~2.2	

Torque specifications listed above are for important fasteners. Others should be tightened to standard torque values below.

STANDARD TORQUE VALUES

SH bolt: 8mm

Flange 6mm bolt

Item	Torque (kg-m)	Item	Torque (kg-m)
5mm bolt, nut	0.45~0.6	5mm screw	0.35~0.5
6mm bolt, nut	0.8~1.2	6mm screw, SH bolt	0.7~1.1
8mm bolt, nut	1.8~2.5	6mm flange bolt, nut	1.0~1.4
10mm bolt, nut	3.0~4.0	8mm flange bolt, nut	2.4~3.0
12mm bolt, nut	5.0~6.0	10mm flange bolt, nut	3.5~4.5

SPECIAL TOOLS

Tool Name	Tool No.	Remarks
Universal bearing puller		Crankshaft bearing removal
Lock nut wrench, 39mm		Drive pulley disassembly/assembly
Lock nut socket wrench		Top cone race holding
Lock nut wrench,		Stem lock nut tightening
Crankcase puller		Crankcase disassembly
Bearing remover set, 12mm (Spindle assy, 15mm) (Remover weight)		Drive shaft bearing removal/installation
Bearing remover set, 15mm (Spindle assy, 15mm) (Remover head, 15mm) (Remover shaft, 15mm)		Drive shaft bearing removal/installation
Bearing outer driver, 28x30mm		Bearing installation
Bearing remover		Driven pulley outer bearing installation
Clutch spring compressor		Driven pulley disassembly/assembly
Crankcase assembly collar		Driven shaft, crankshaft & crankcase assembly
Crankcase assembly tool		Crankshaft & crankcase assembly
Rear shock absorber remover		Front shock absorber disassembly/assembly
Ball race remover		Steering stem bearing races
Rear shock absorber compressor		Rear shock absorber disassembly/assembly
Float level gauge		Carburetor fuel level check
Lock nut socket wrench, 32mm		One-way clutch lock nut removal/installation
Universal holder		Flywheel holding
Flywheel puller		Flywheel removal
Pilot, 12mm		Drive shaft bearing installation
Bearing outer driver, 32x35mm		Drive shaft bearing installation Final shaft bearing installation

2. GENERAL INFORMATION

SUPER8 50 2T

Tool Name	Tool No.	Remarks
Bearing outer driver, 37x40mm		Drive shaft bearing installation Final shaft bearing installation Crankshaft bearing installation
Outer driver, 24x26mm		Driven pulley bearing installation
Pilot, 10mm		Front wheel bearing installation
Bearing driver pilot, 17mm		Drive shaft bearing installation
Snap ring pliers (close)		Circlip removal/installation
Bearing outer driver, 42x47mm		Crankshaft bearing installation
Pilot, 20mm		Crankshaft bearing installation
Bearing outer driver handle A		Bearing installation Drive in ball race
Bearing puller head, 10mm		Front wheel bearing removal
Universal bearing puller		Crankshaft bearing removal
Bearing puller		Front wheel bearing removal
Pressure tester set		Cylinder compression gauge

LUBRICATION POINTS

ENGINE

NO.	Lubrication Points	Lubricant	Remarks
1	Crankcase sliding & movable	JASO-FC or API-TC	
2	Cylinder movable parts		
3	Transmission gear (final gear)	SAE-90#	
4	Kick starter spindle bushing	Grease	
5	Drive pulley movable parts	Grease	
6	Starter pinion movable parts	Grease	

FRAME

Apply clean engine oil or grease to cables and movable parts not specified. This will avoid abnormal noise and rise the durability of the motorcycle.

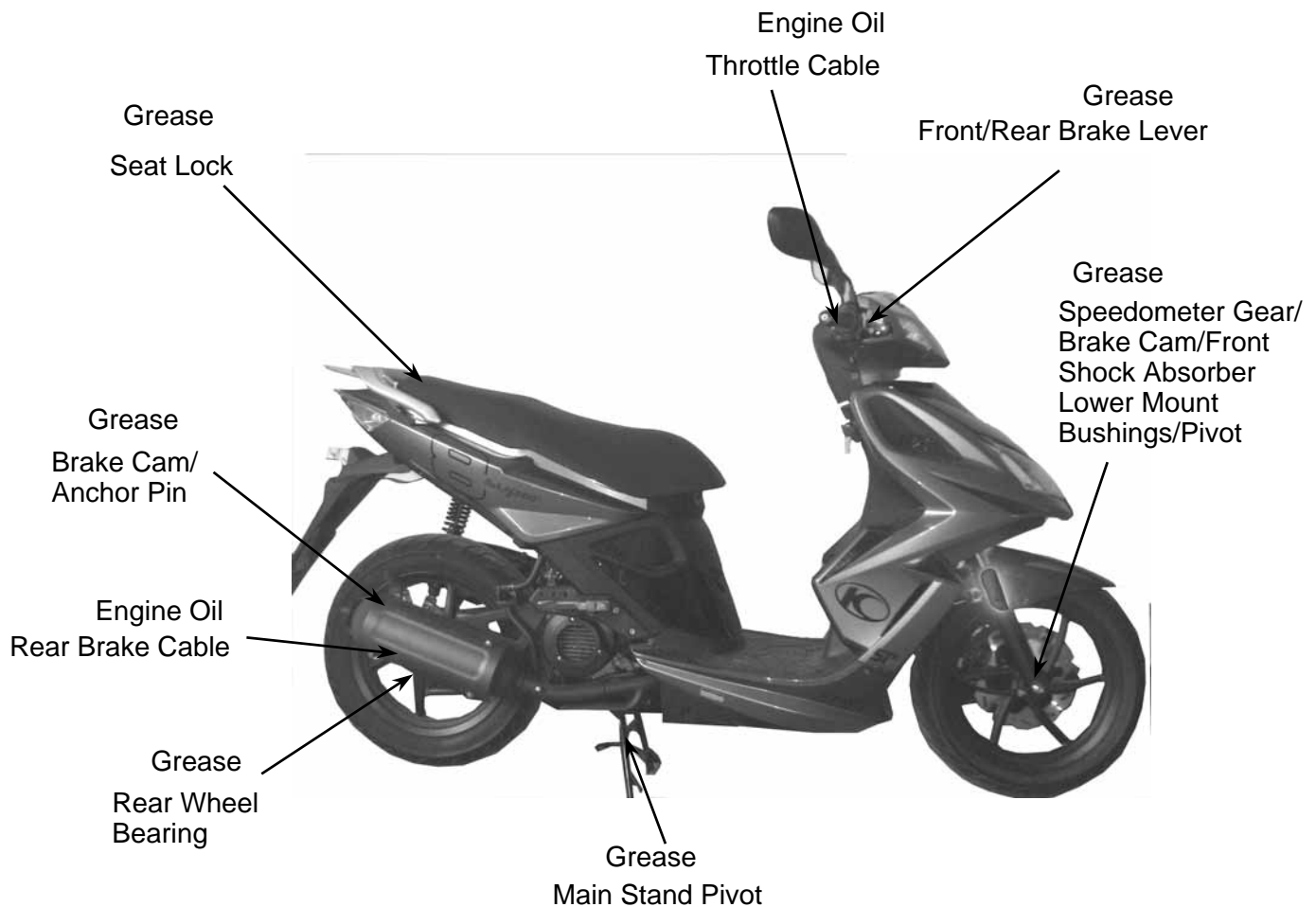

2. GENERAL INFORMATION

SUPER8 50 2T

PEOPLE S 50 WIRING DIAGRAM

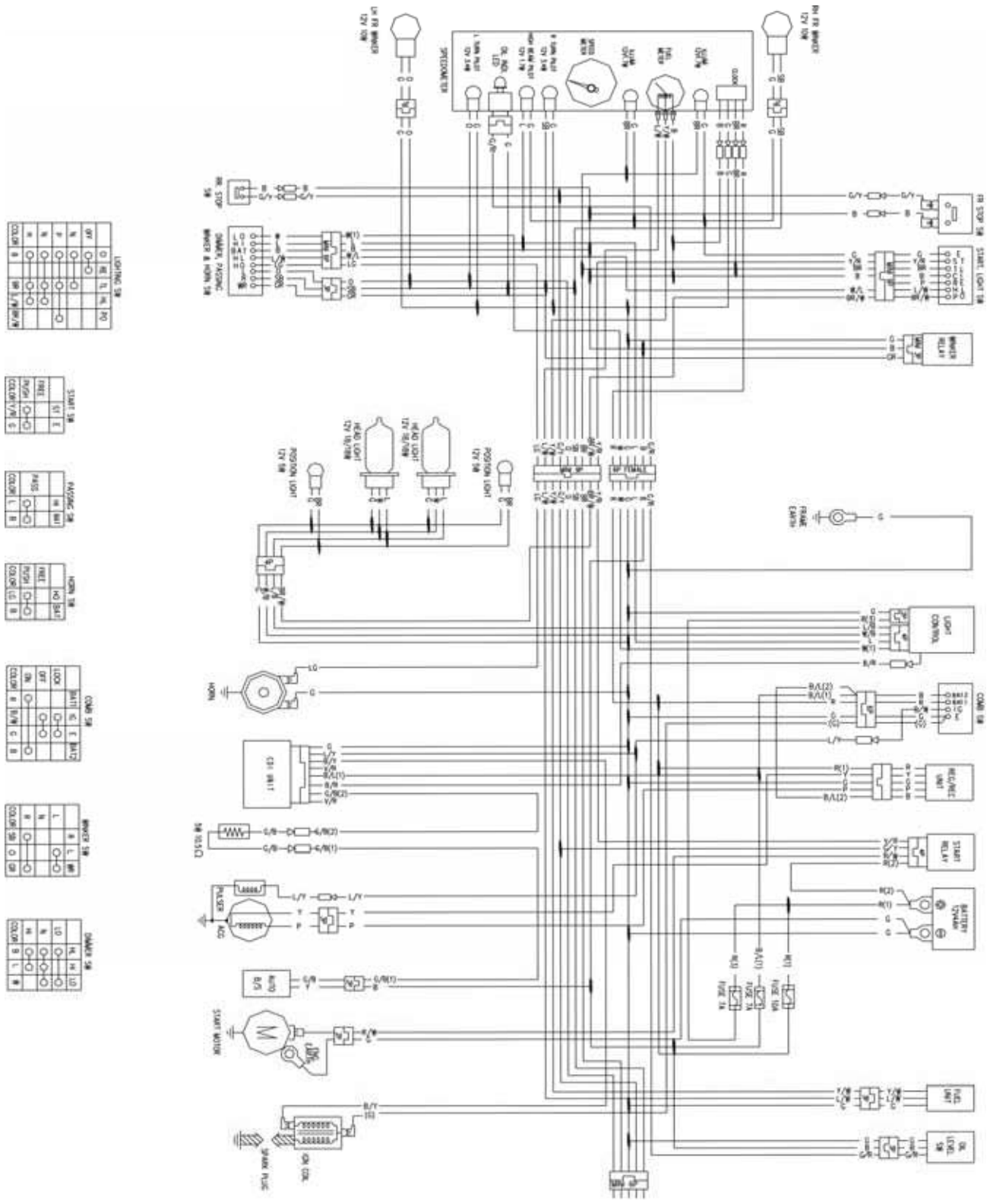

MS 0001

MS 0001	MS 0002	MS 0003	MS 0004	MS 0005	MS 0006	MS 0007	MS 0008
○	○	○	○	○	○	○	○
○	○	○	○	○	○	○	○
○	○	○	○	○	○	○	○
○	○	○	○	○	○	○	○

MS 0002

MS 0002	MS 0003	MS 0004	MS 0005	MS 0006	MS 0007	MS 0008
○	○	○	○	○	○	○
○	○	○	○	○	○	○
○	○	○	○	○	○	○
○	○	○	○	○	○	○

MS 0003

MS 0003	MS 0004	MS 0005	MS 0006	MS 0007	MS 0008
○	○	○	○	○	○
○	○	○	○	○	○
○	○	○	○	○	○
○	○	○	○	○	○

MS 0004

MS 0004	MS 0005	MS 0006	MS 0007	MS 0008
○	○	○	○	○
○	○	○	○	○
○	○	○	○	○
○	○	○	○	○

MS 0005

MS 0005	MS 0006	MS 0007	MS 0008
○	○	○	○
○	○	○	○
○	○	○	○
○	○	○	○

MS 0006

MS 0006	MS 0007	MS 0008
○	○	○
○	○	○
○	○	○
○	○	○

MS 0007

MS 0007	MS 0008
○	○
○	○
○	○
○	○

CABLE & HARNESS ROUTING

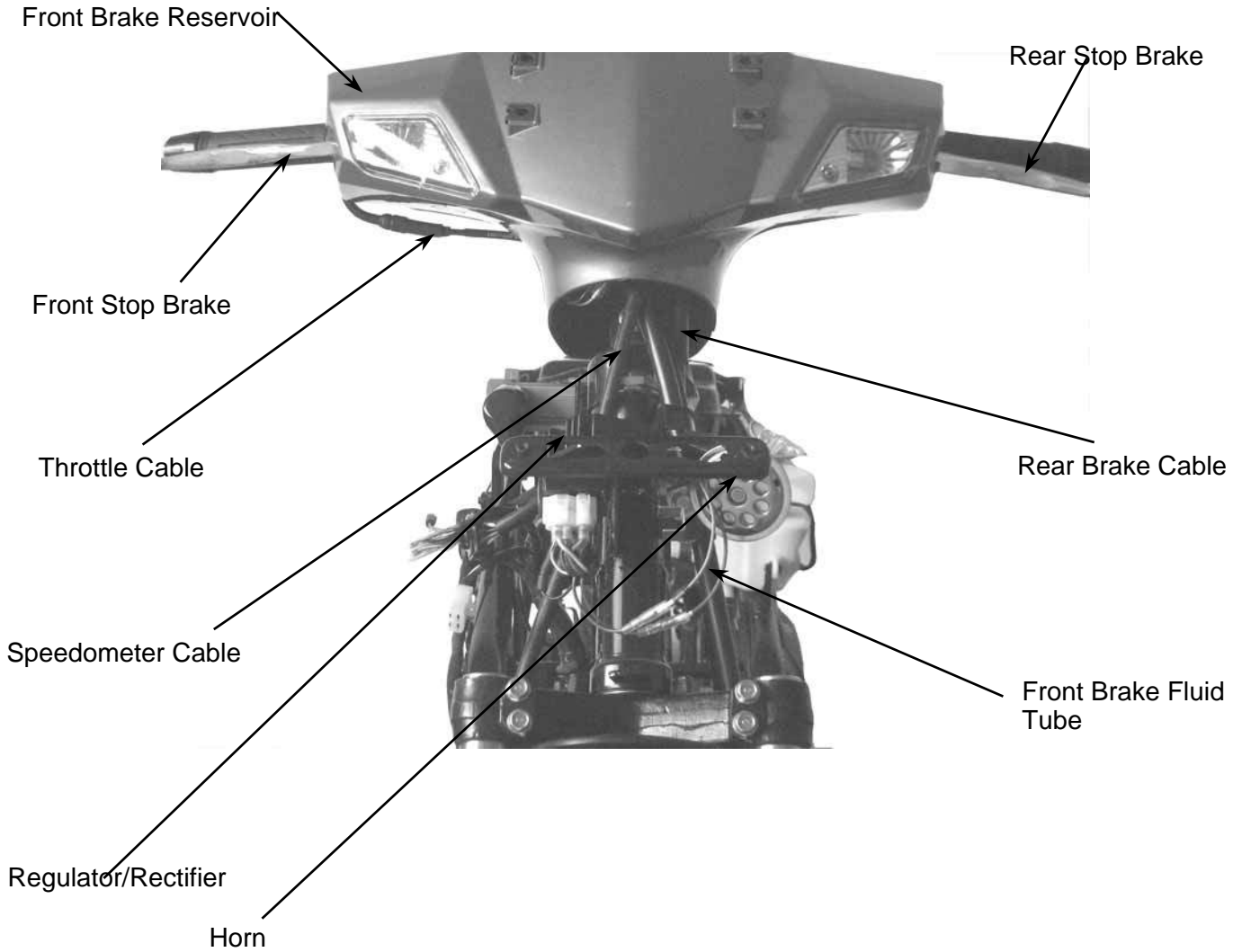

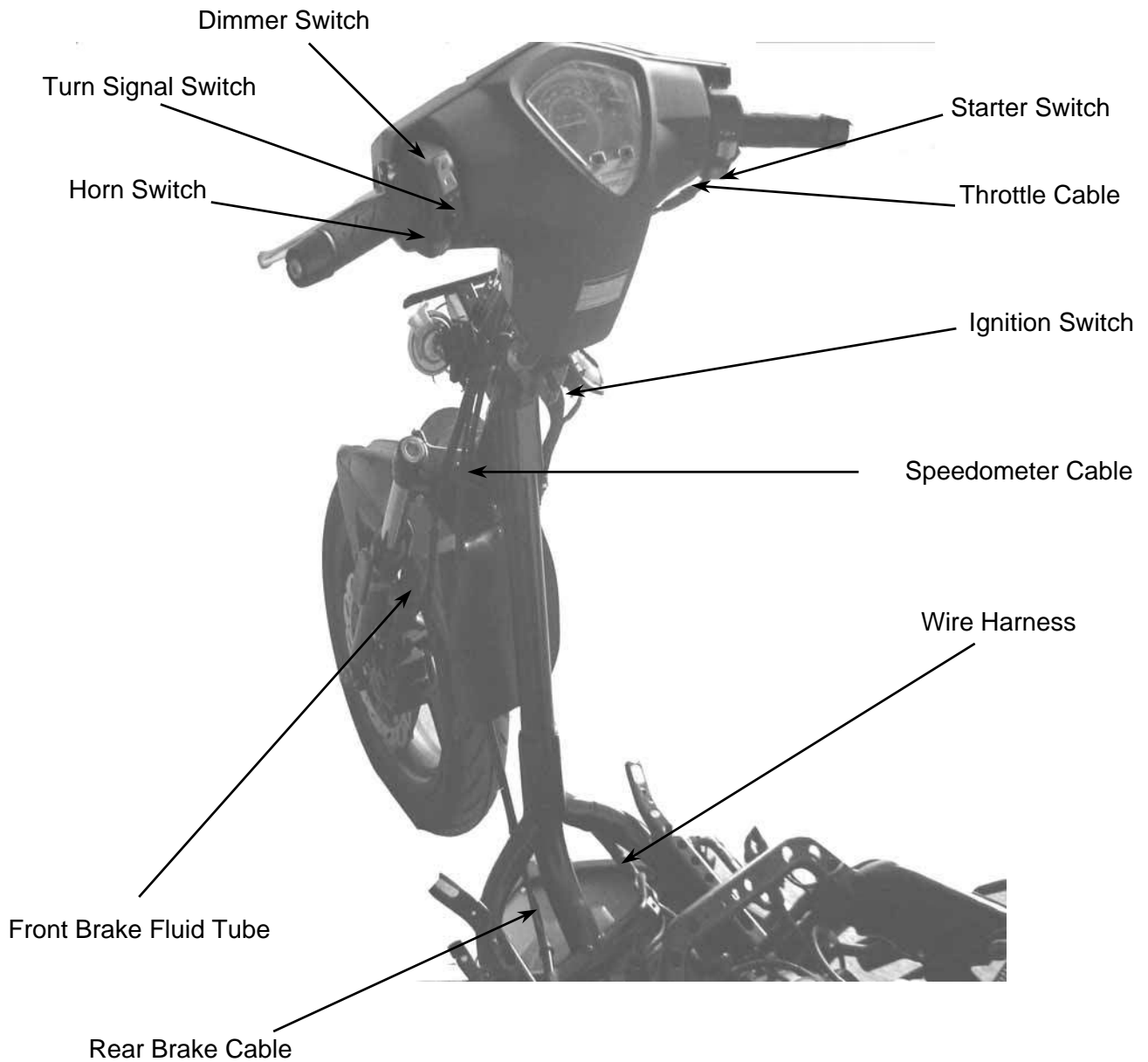

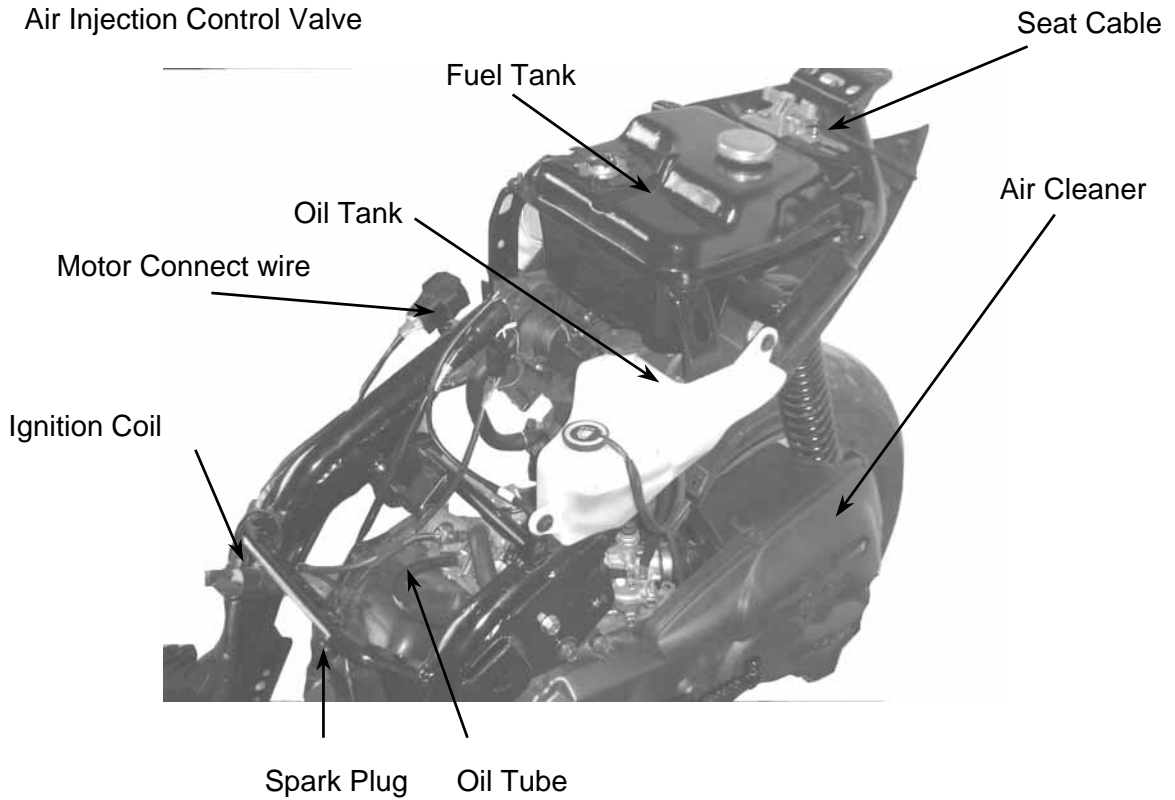
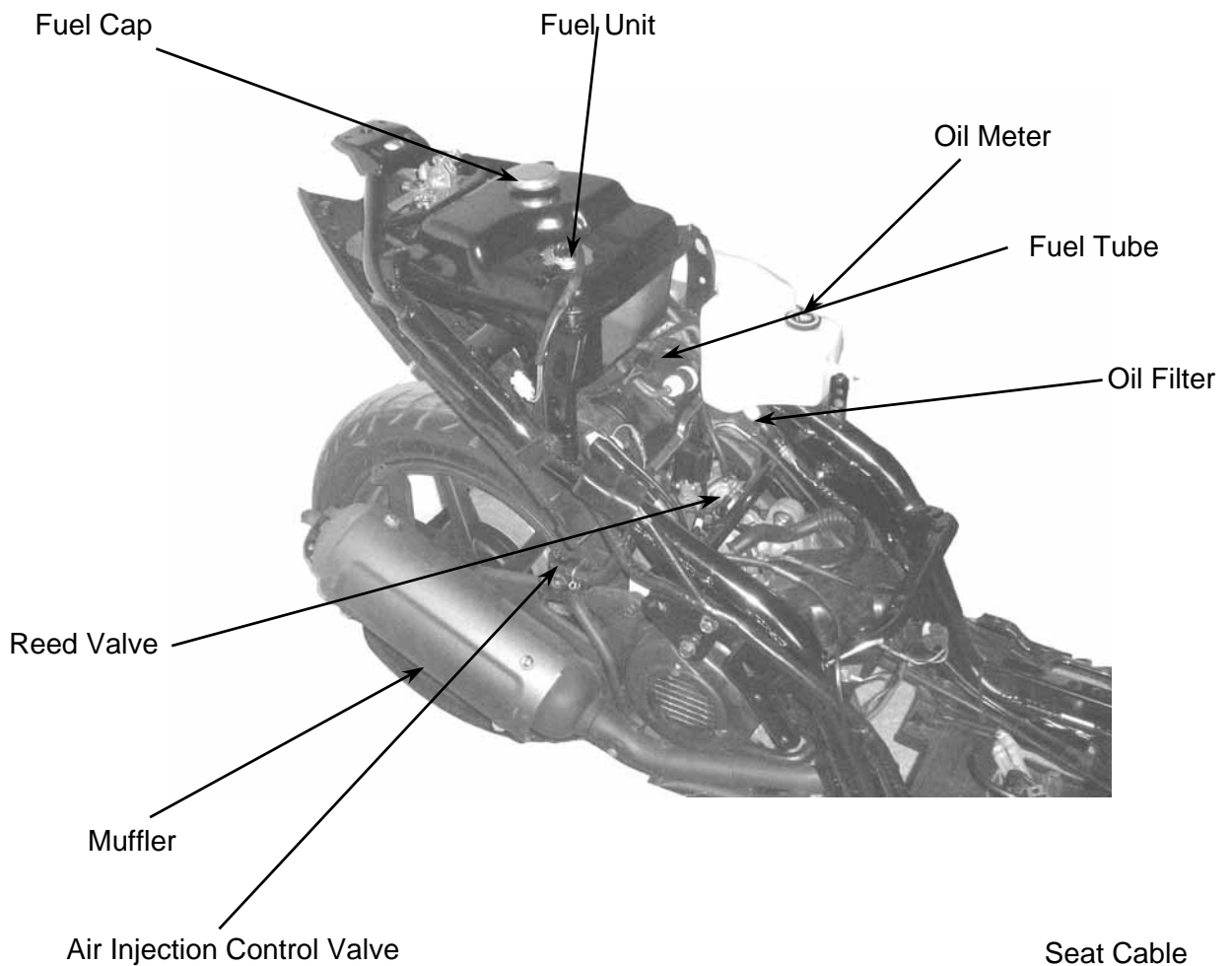

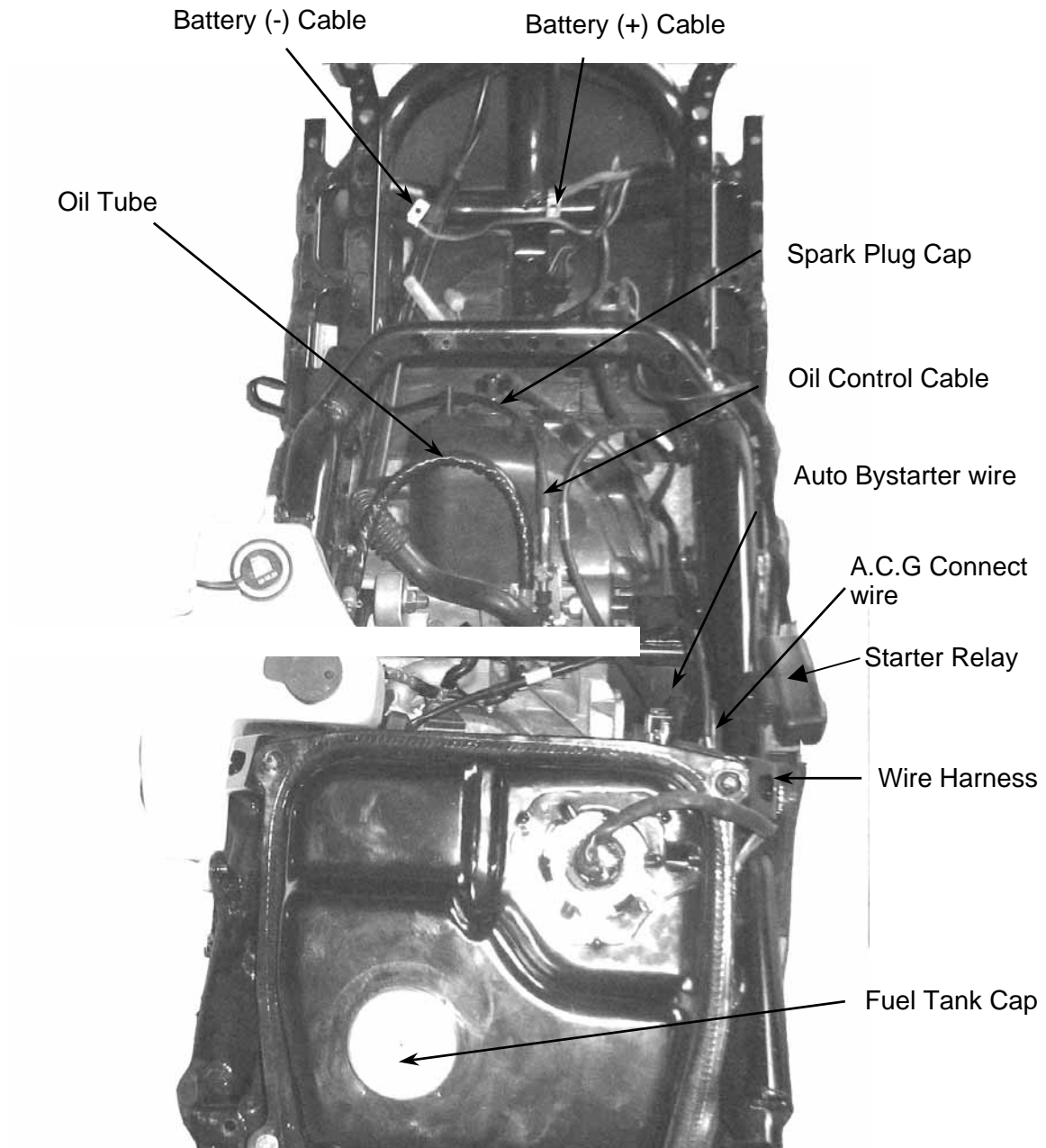

TROUBLESHOOTING

ENGINE WILL NOT START OR IS HARD TO START

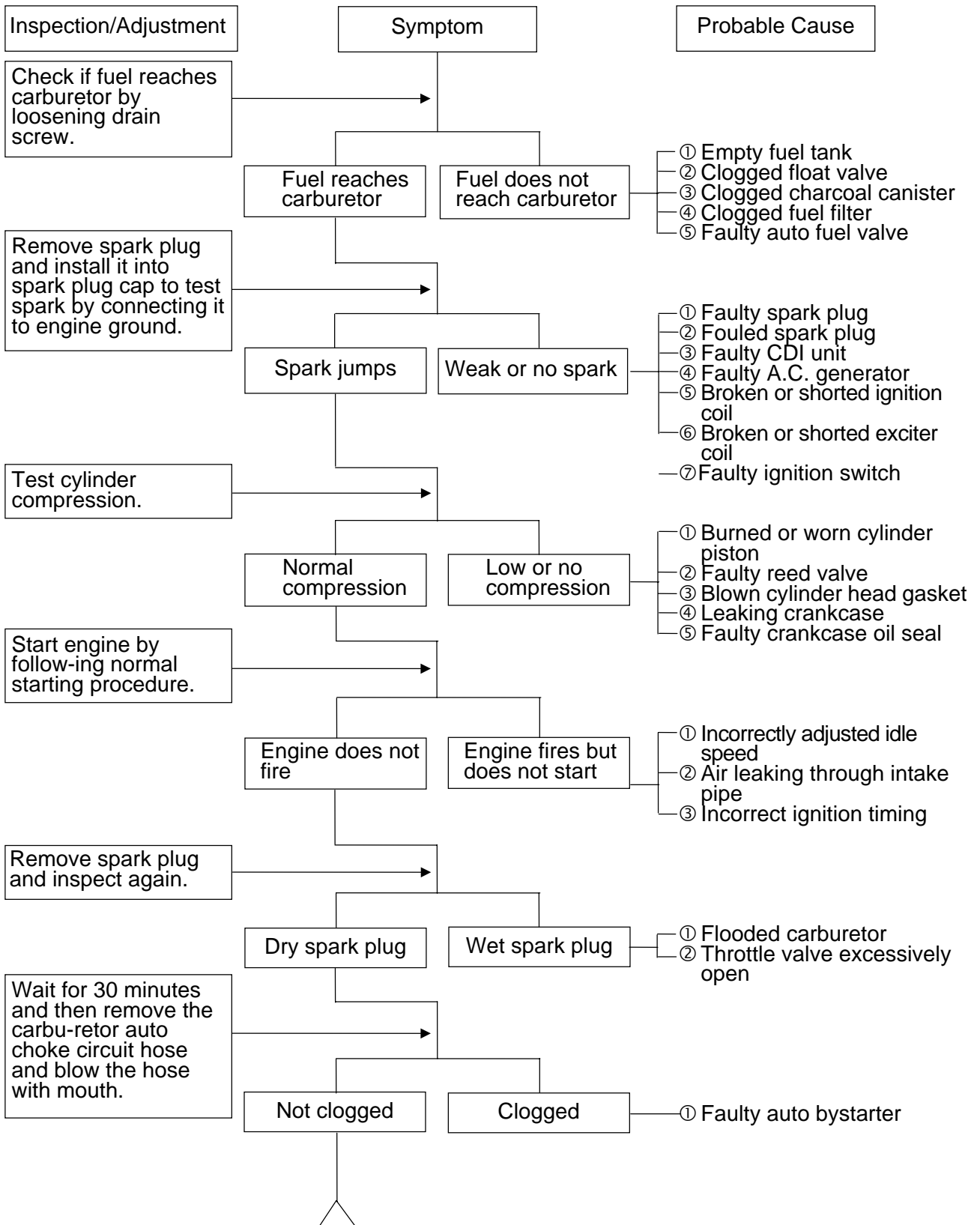

ENGINE STOPS IMMEDIATELY AFTER IT STARTS

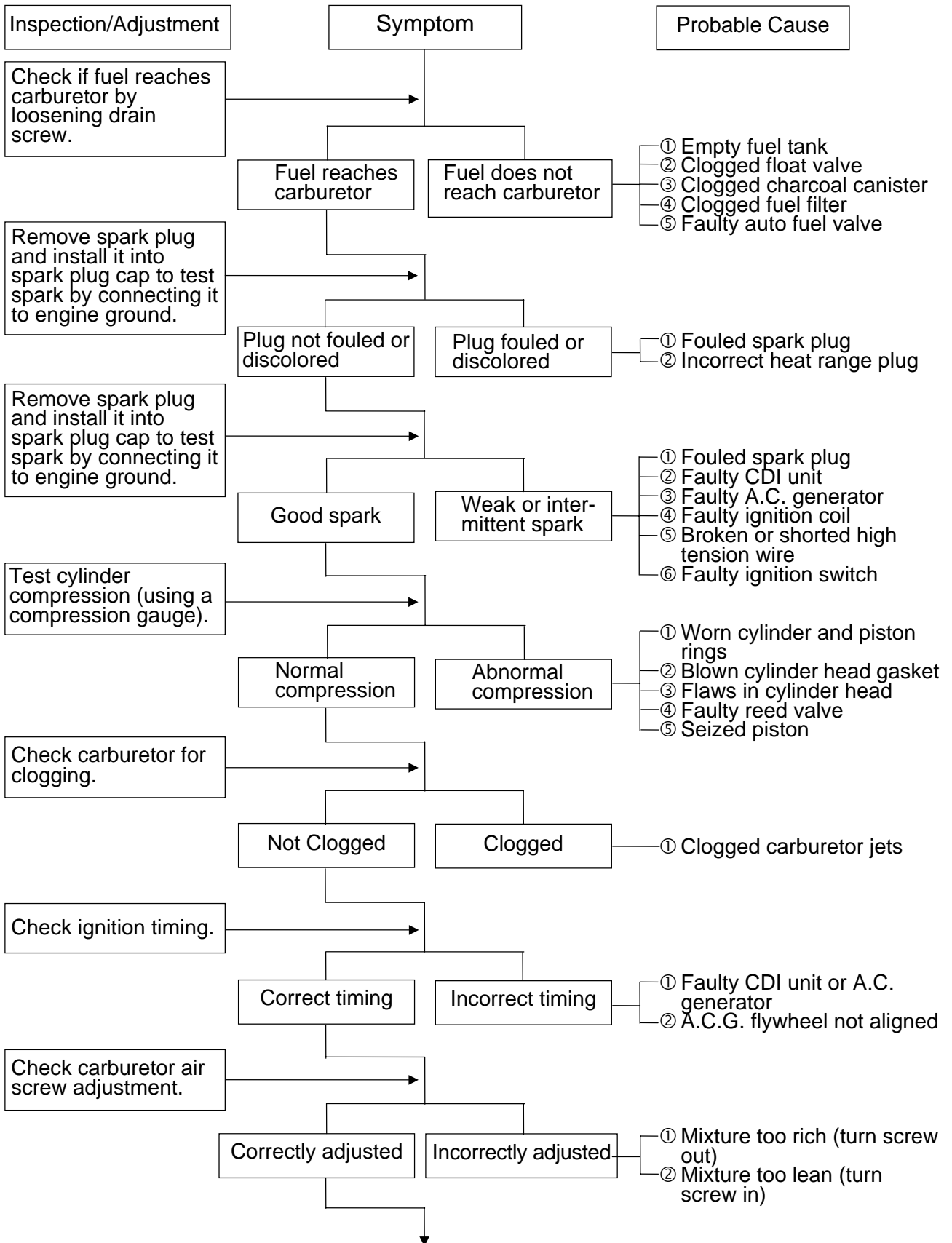

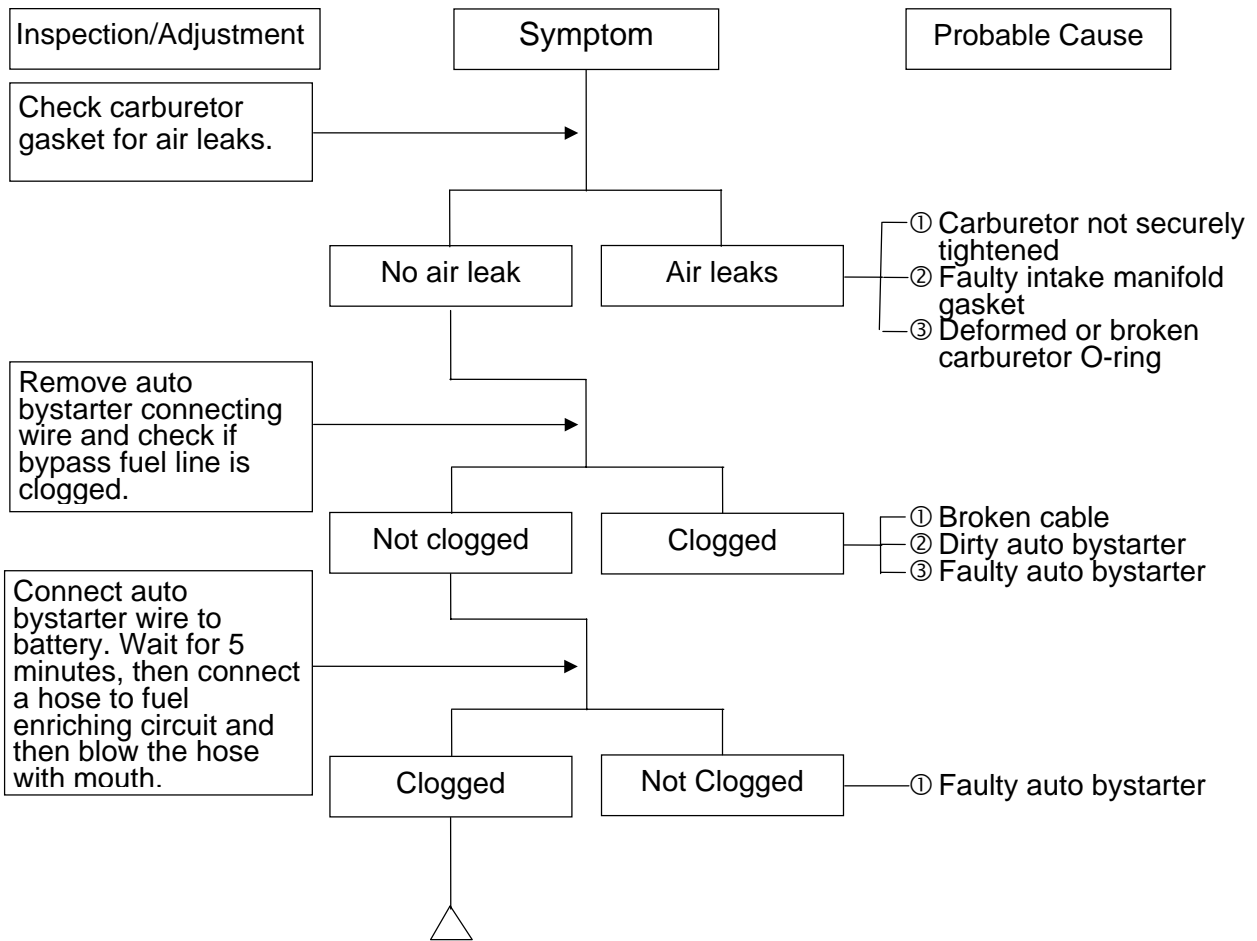

ENGINE LACKS POWER

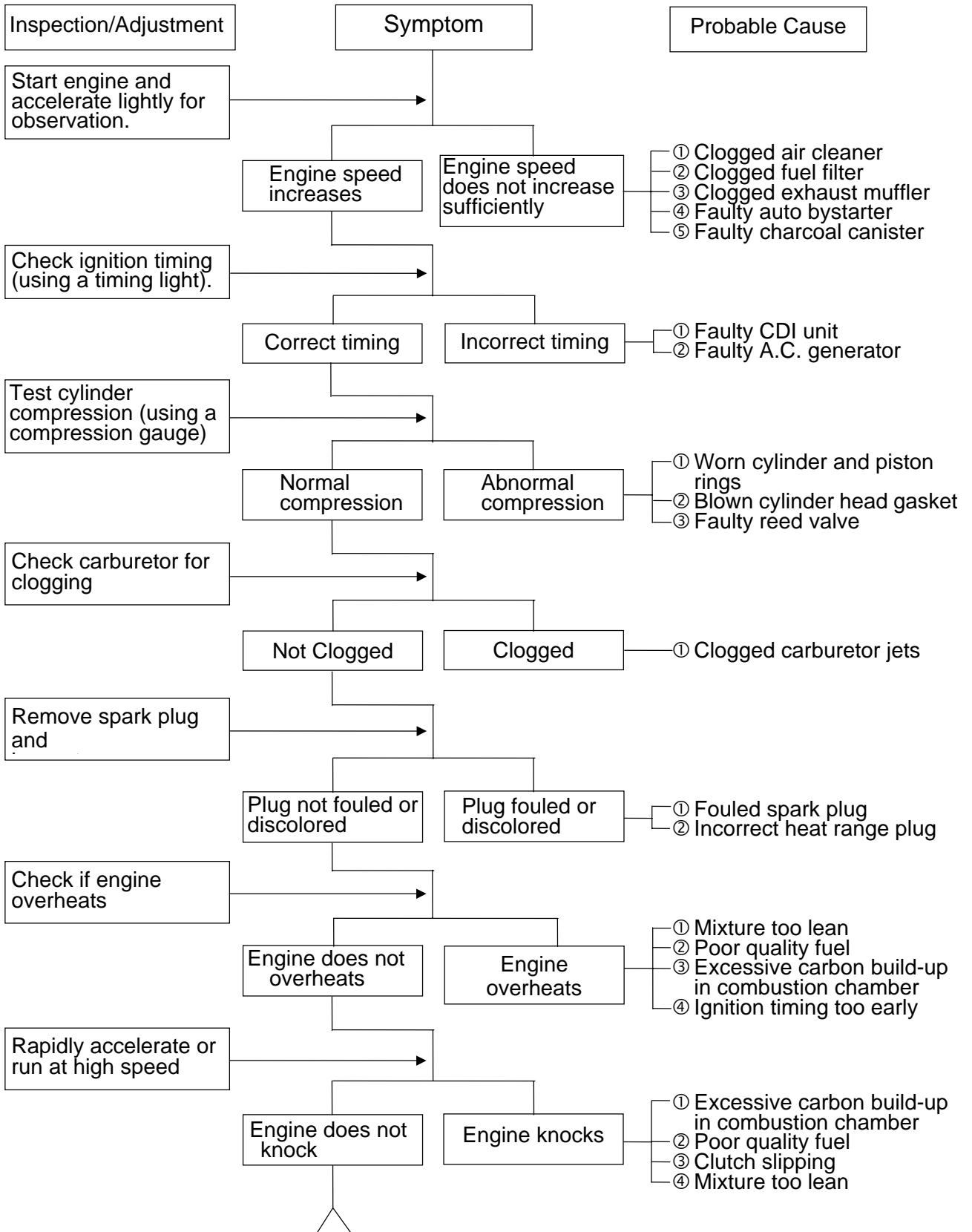

POOR PERFORMANCE (ESPECIALLY AT IDLE AND LOW SPEEDS)

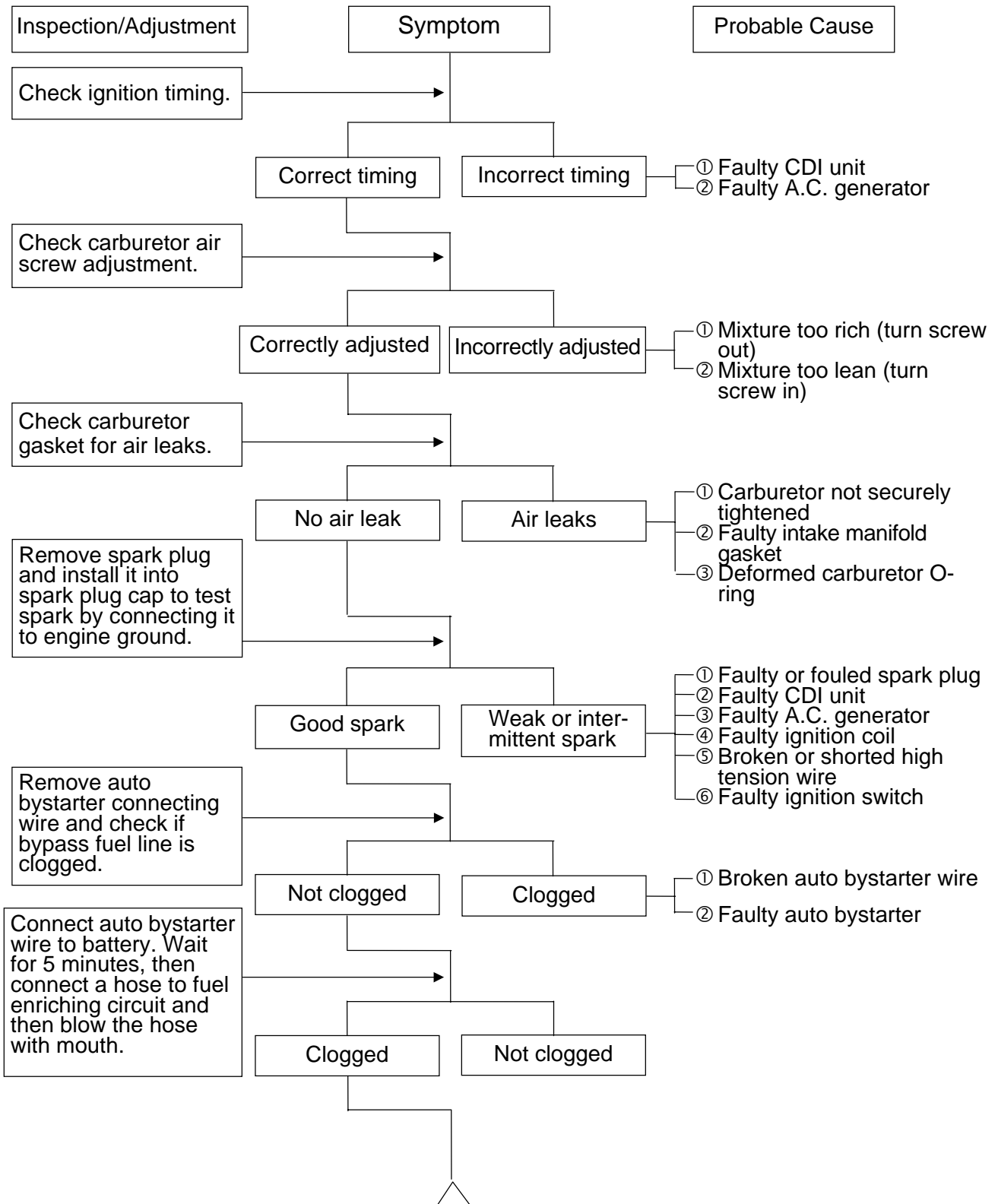

POOR PERFORMANCE (AT HIGH SPEED)

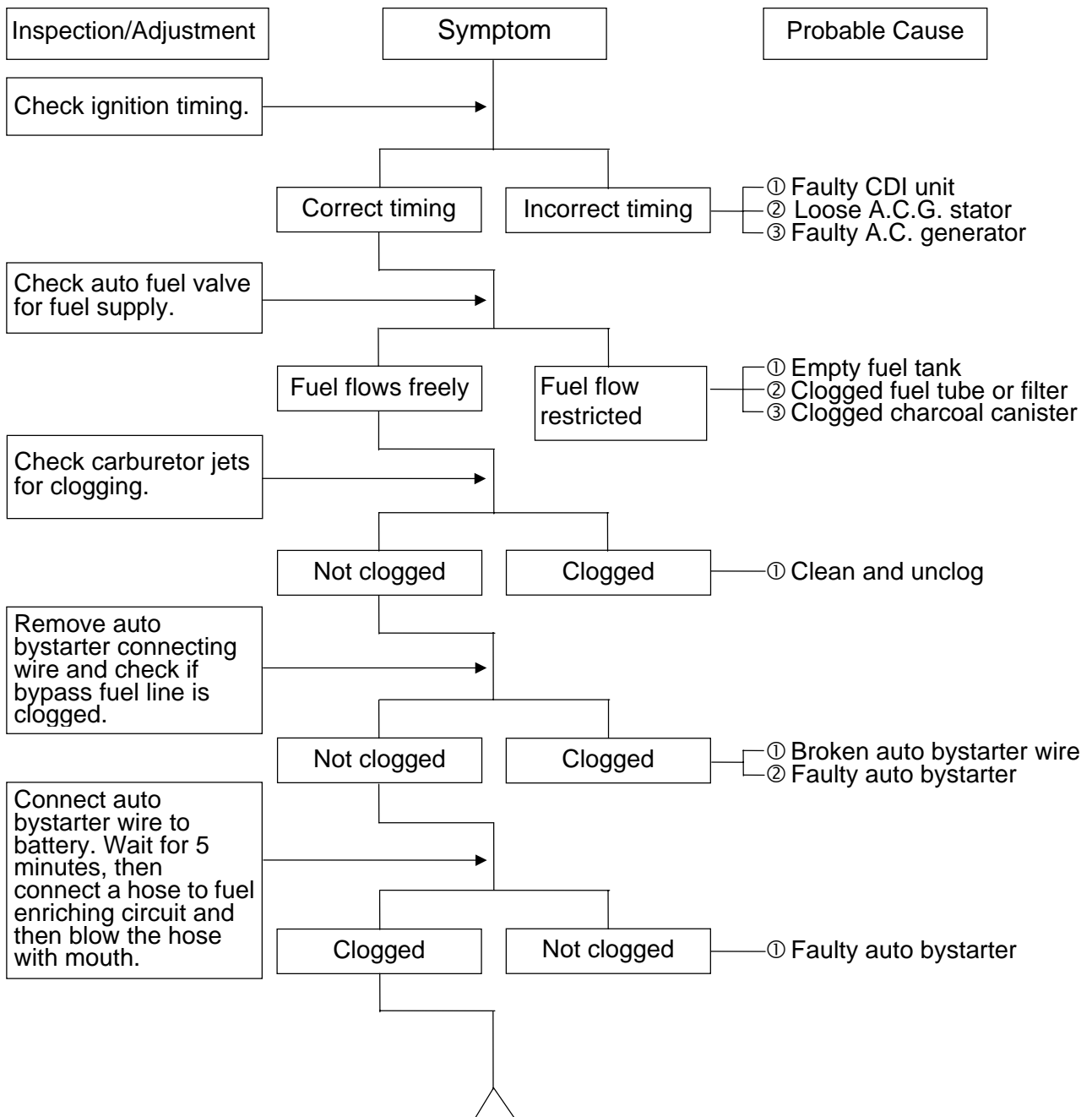

CLUTCH, DRIVE AND DRIVEN PULLEYS

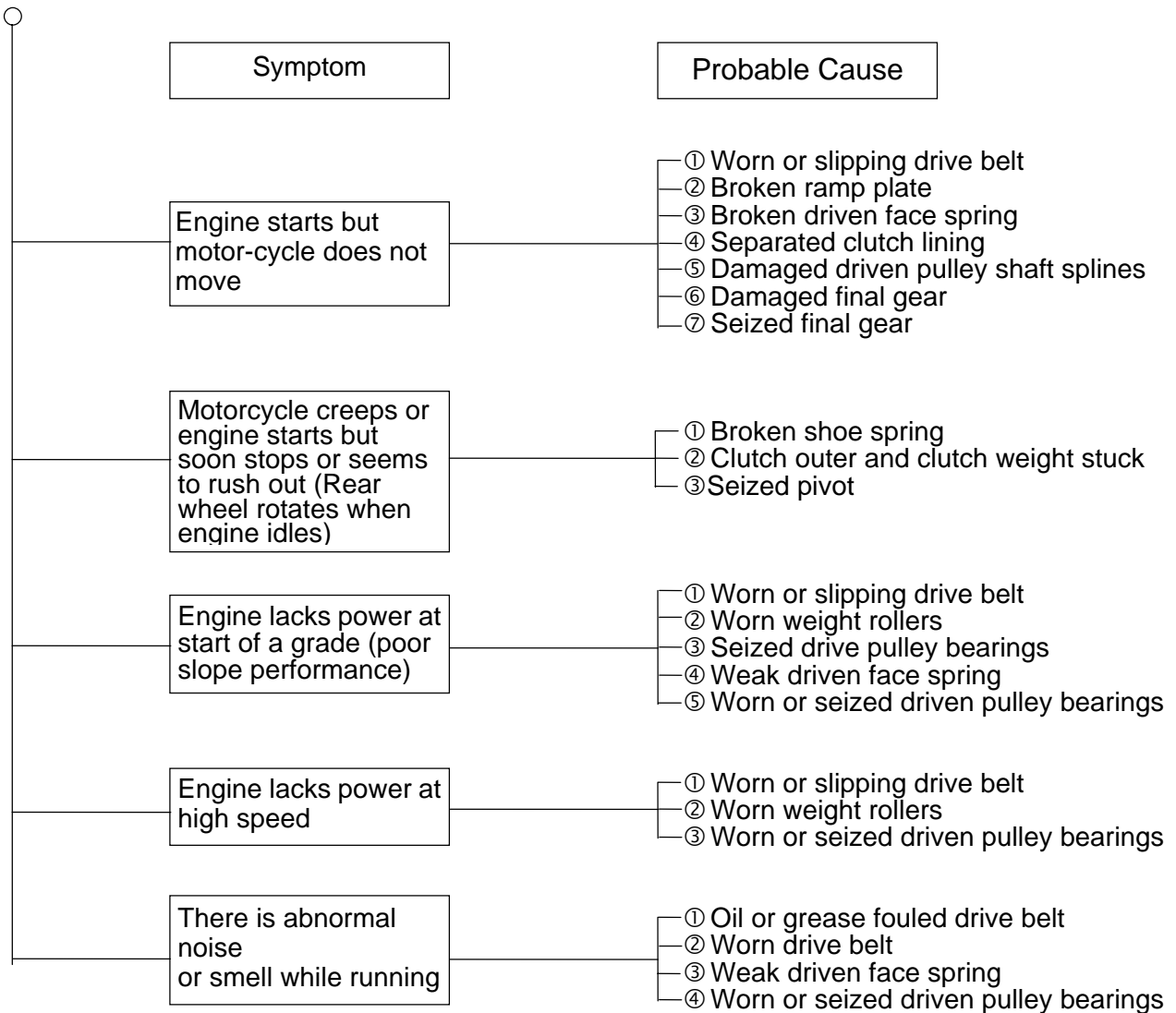

STEERING HANDLEBAR DOES NOT TRACK STRAIGHT

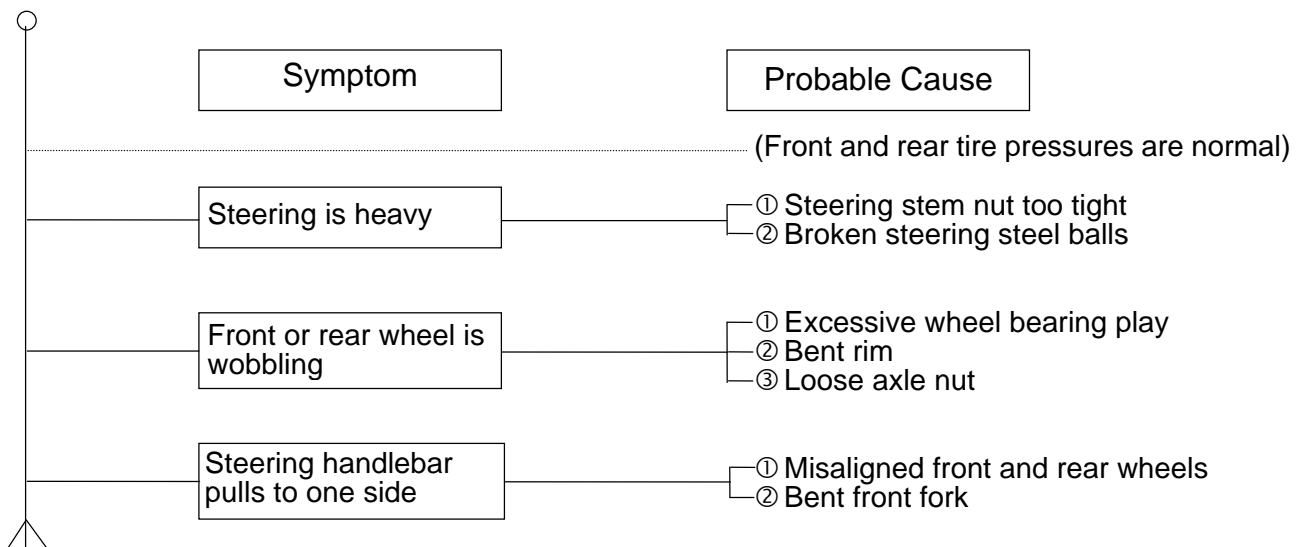

POOR SUSPENSION PERFORMANCE

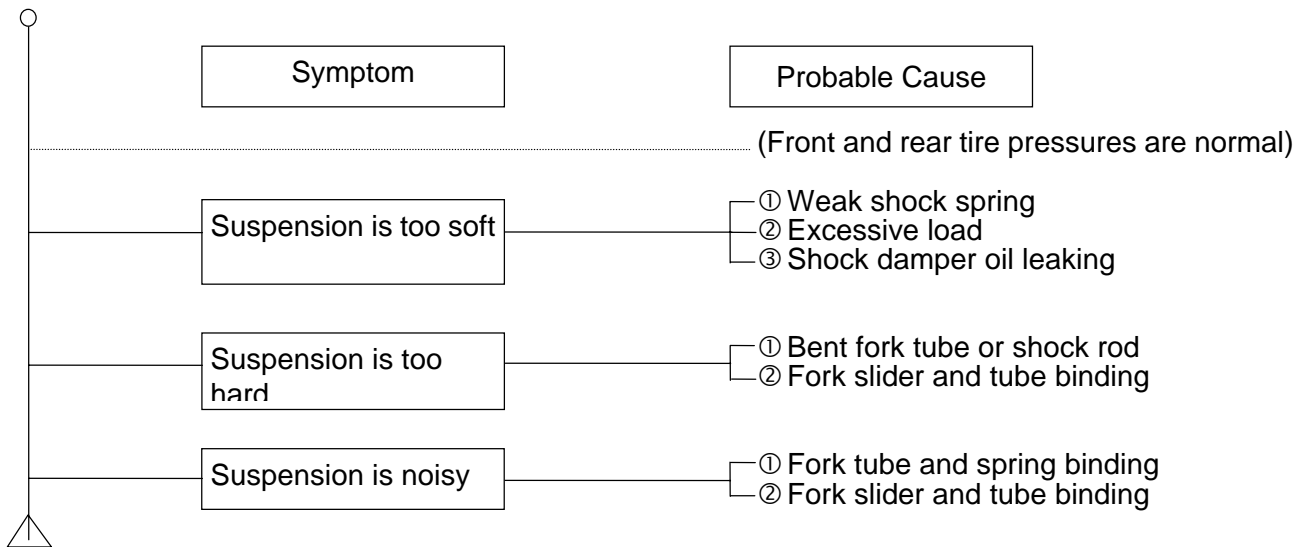

POOR BRAKE PERFORMANCE

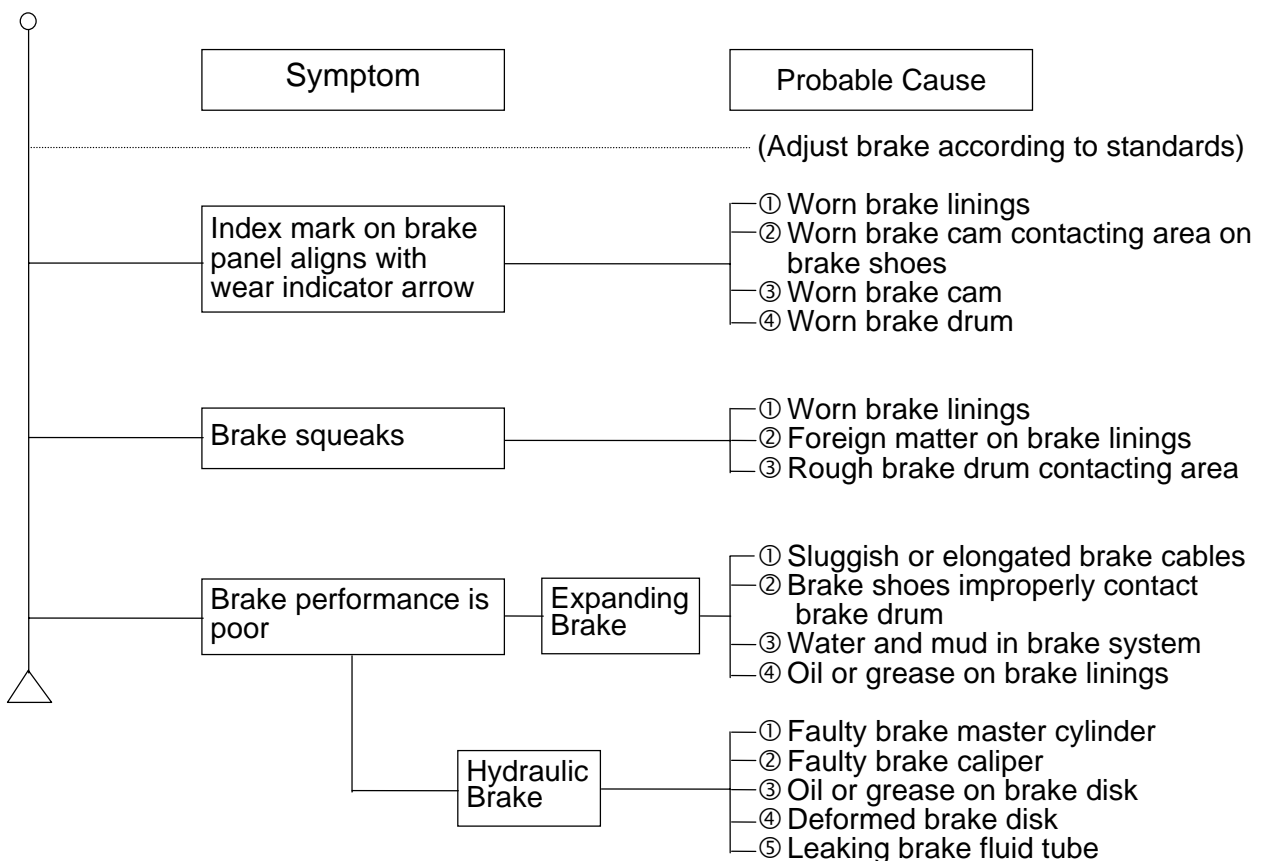

OIL METER

1. Motor oil indicator light does not come on when there is no motor oil (Ignition switch ON)

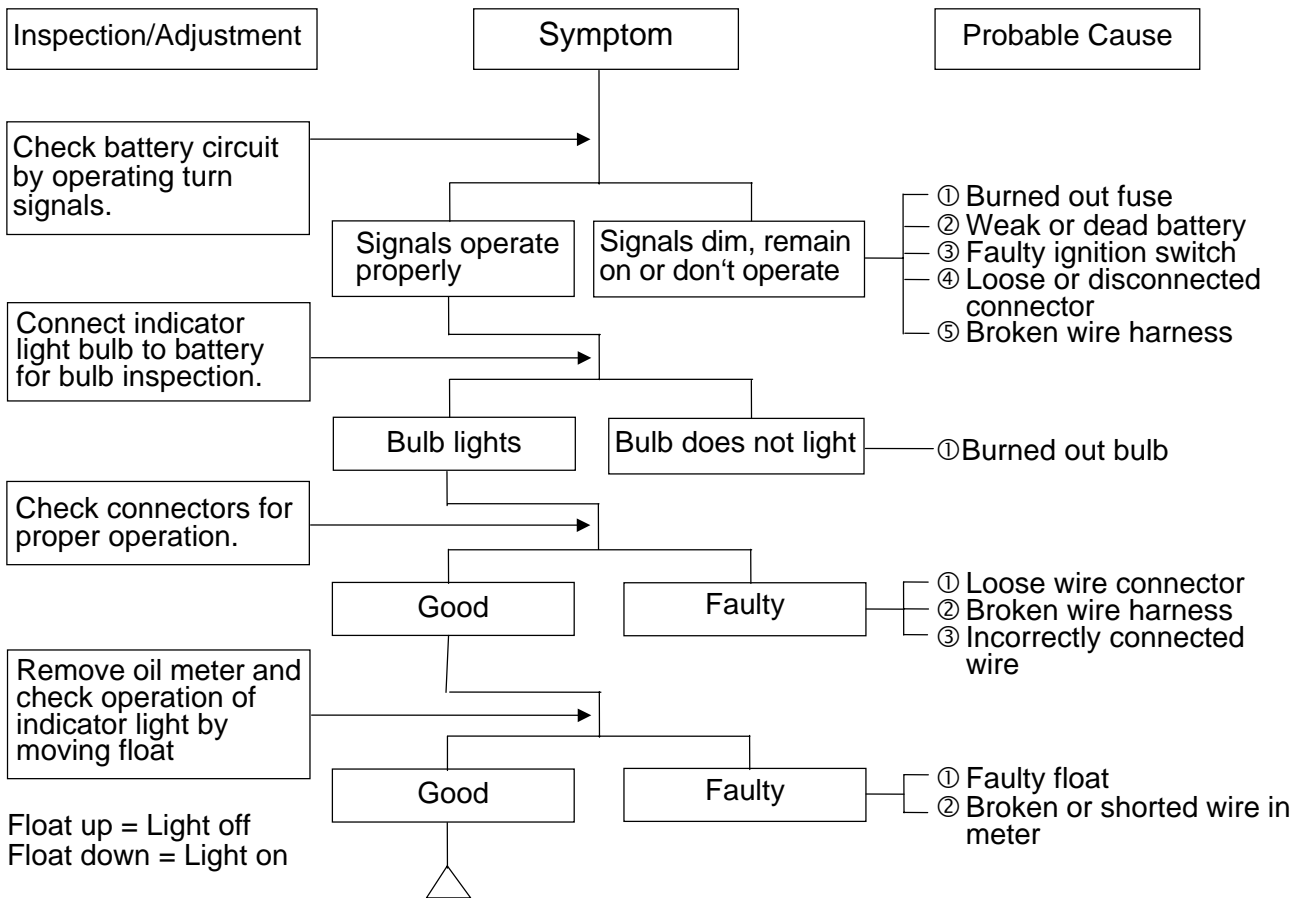

2. Motor oil is sufficient but the indicator light remains on (Ignition switch ON)

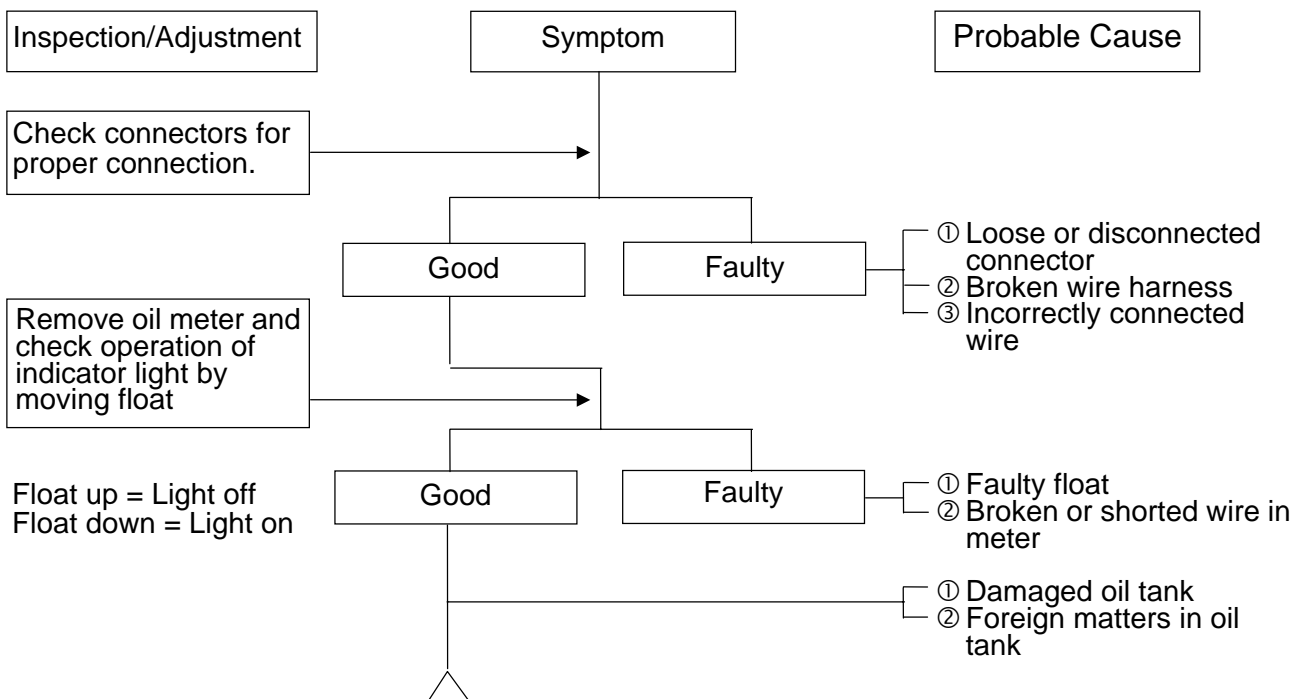

FUEL GAUGE

1. Pointer does not register correctly (Ignition switch ON)

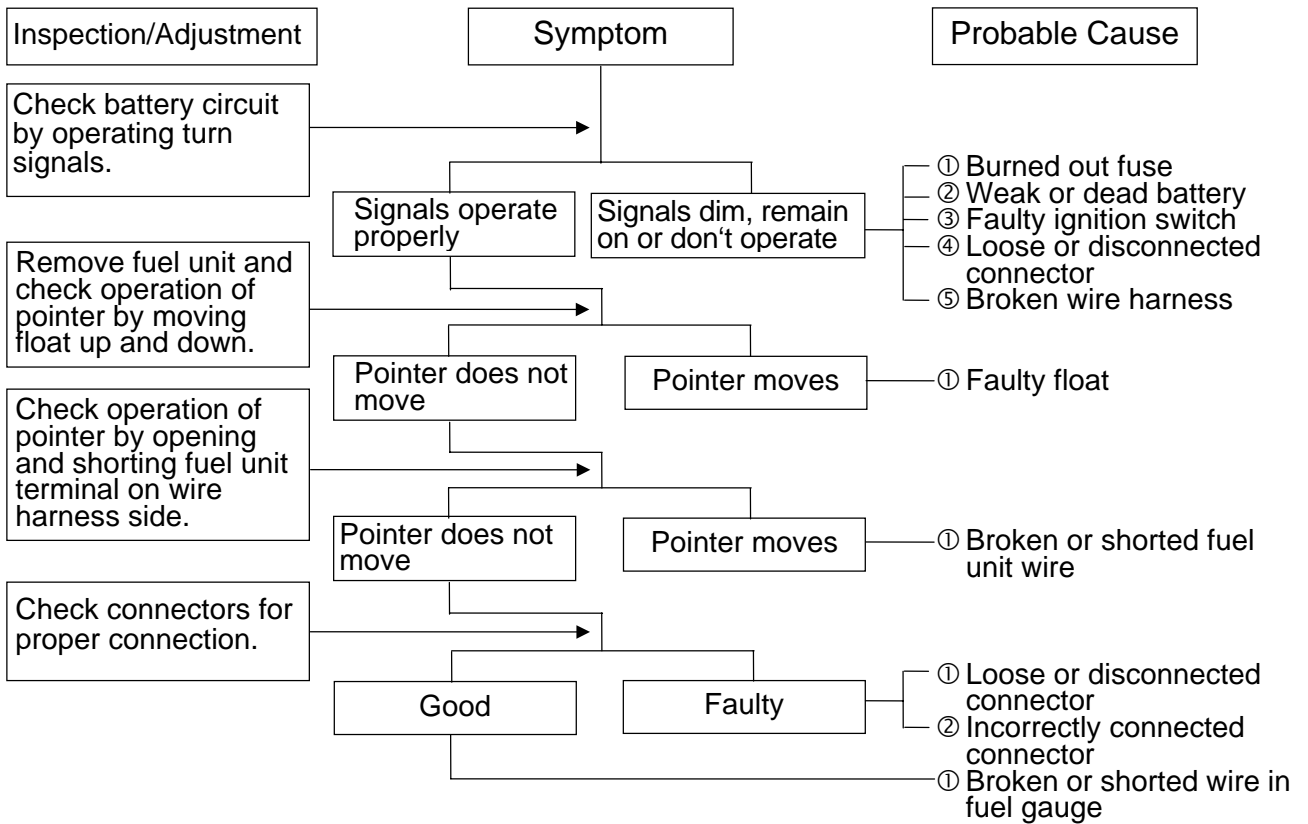

2. Pointer fluctuates or swings (Ignition switch ON)

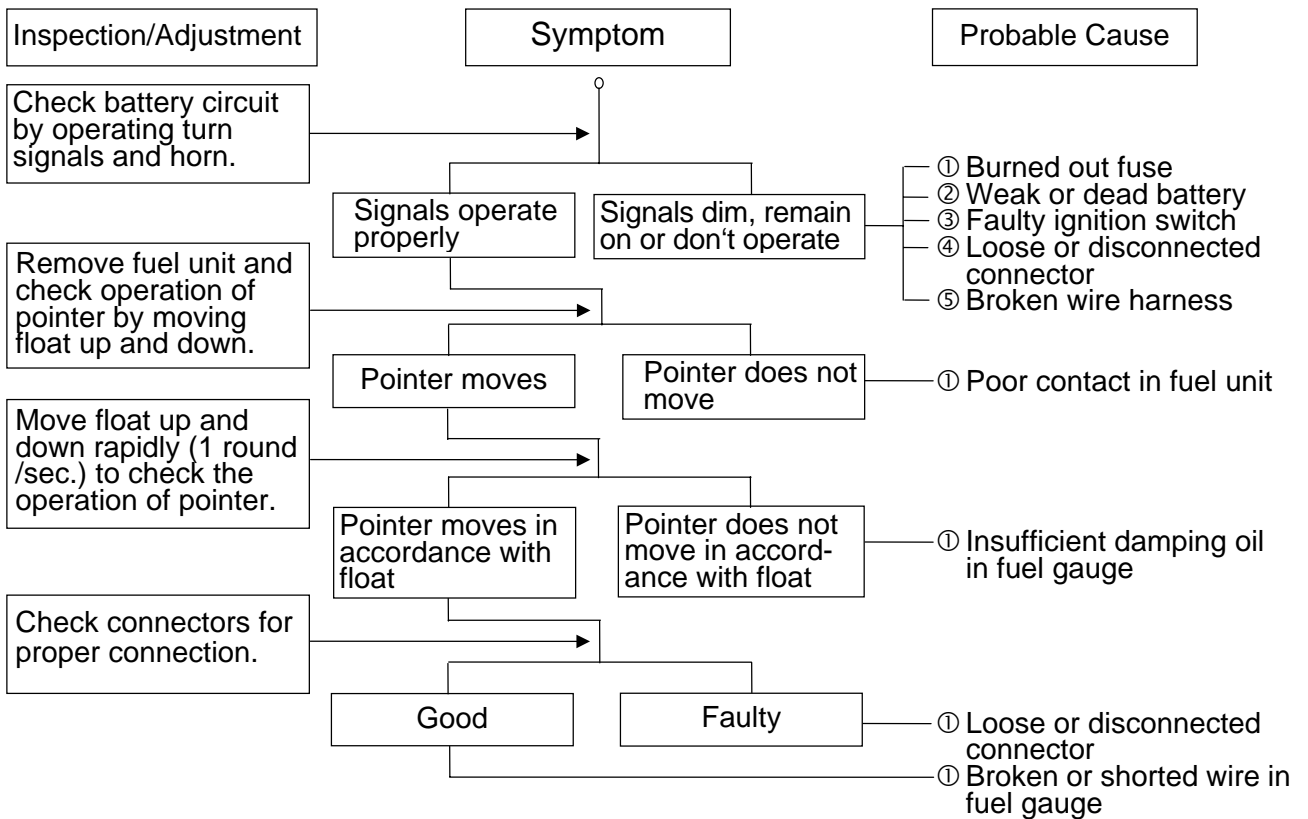

STARTER MOTOR

1. Starter motor won't turn

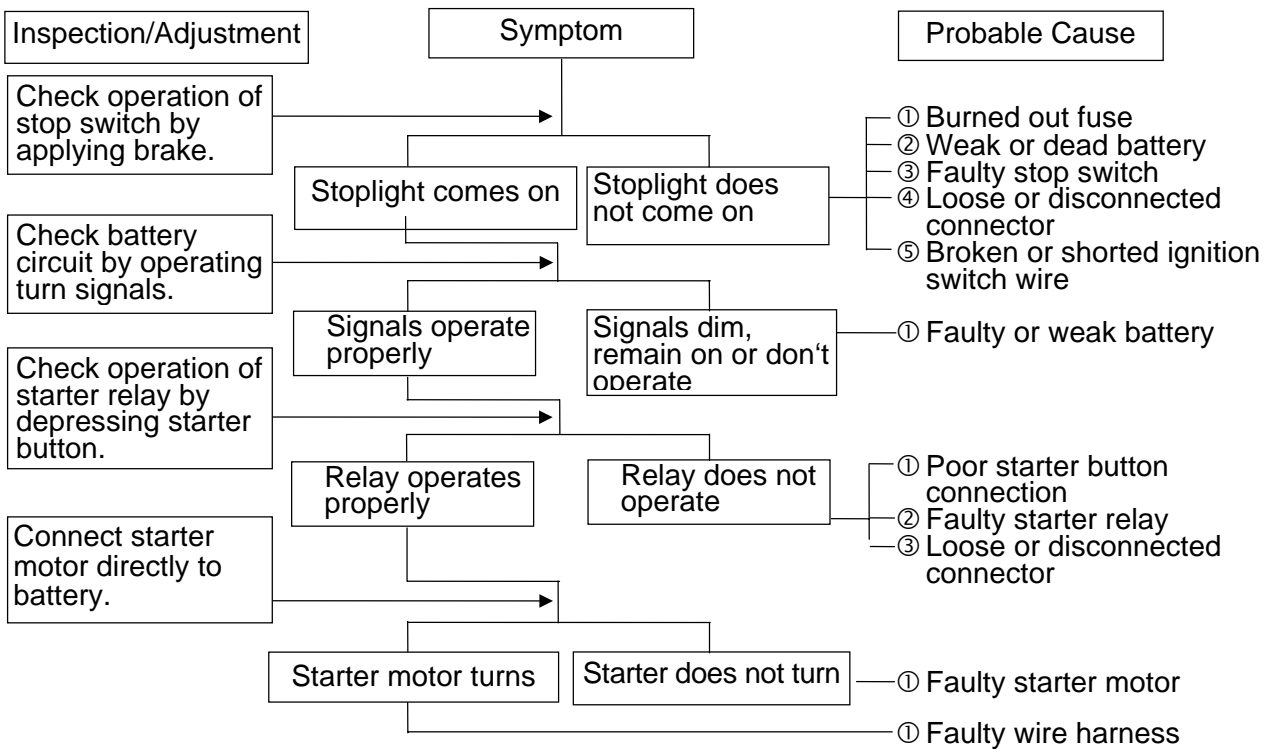

2. Starter motor turns slowly or idles

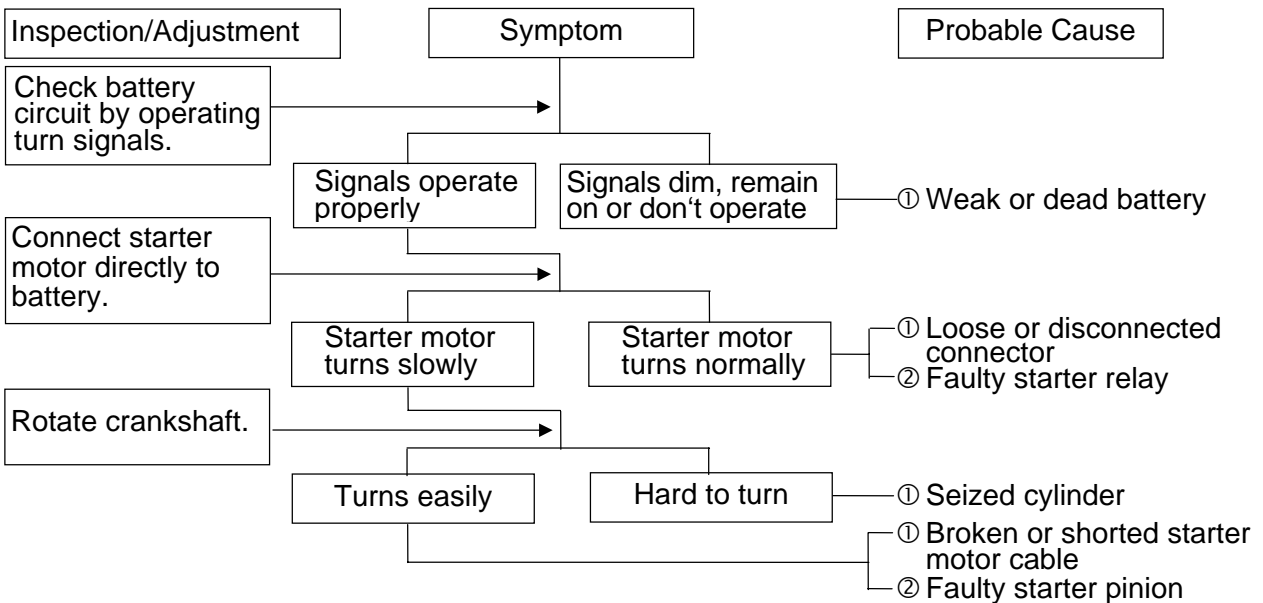

3. Starter motor does not stop turning

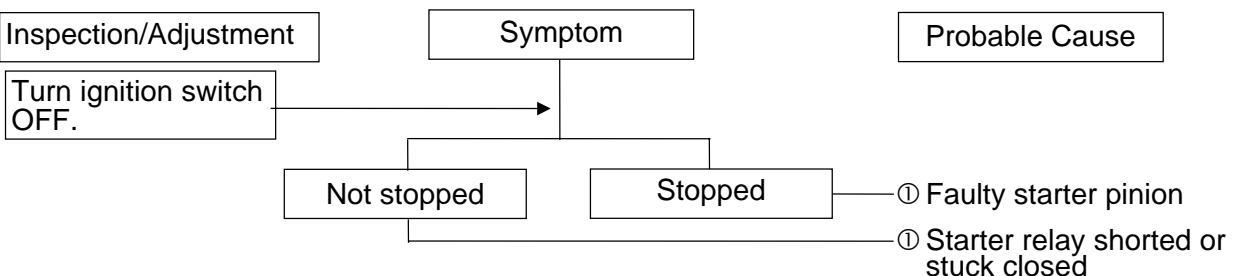

INSPECTION/ADJUSTMENT

INSPECTION AND MAINTENANCE SCHEDULE3- 1
BRAKE SYSTEM3- 4
MOVING DEVICE3- 6
DAMPING DEVICE3- 7
POWER DRIVE SYSTEM.....3- 7
ELECTRICAL EQUIPMENT3- 8
ENGINE3- 9
OTHERS3-12

INSPECTION AND MAINTENANCE SCHEDULE

(Note) 1. ○ means time for inspection.

2. ☆ means regular replacement for the specified parts.

This inspection and maintenance schedule is based upon average riding conditions. Machines subjected to severe use, or ridden in unusually dusty areas, require more frequent servicing.

Inspection & Maintenance Item			Frequency				Judgment Standards	Remarks								
			Prior	1st month	Every 6 months	Every 12 months										
Suspension	Steering handlebar	Check for looseness and vertical play				○										
		Operating performance	○			○										
		Right/left turning angle				○										
	Front fork	Damage			○	○										
		Check for front fork pivot installation			○	○		Check steering stem								
Check front fork pivot for looseness and abnormal noise					○		Check steering stem									
Brake System	Brake Lever	Front/rear brake lever free play			○	○	Free play: 10~20mm									
		Brake lever operation	○													
		Brake performance		○	○	○										
	Lever/Cable	Looseness, abnormal noise and damage		○		○										
	Brake drum/ shoe	Drum-to-lining clearance			○	○										
		Brake shoe and lining wear				☆		Indicator type								
Brake drum wear and damage					○	Standard: Rear : 110 mm Service Limits: Rear : 111 mm										
Moving Device	Tire	Tire pressure	○		○	○	<table border="1"> <thead> <tr> <th></th> <th>Front</th> <th>Rear</th> </tr> </thead> <tbody> <tr> <td>1 rider</td> <td>1.75 kg/cm²</td> <td>2.25 kg/cm²</td> </tr> <tr> <td>Tire Size</td> <td>100/80-16</td> <td>110/70-16</td> </tr> </tbody> </table>		Front	Rear	1 rider	1.75 kg/cm ²	2.25 kg/cm ²	Tire Size	100/80-16	110/70-16
	Front	Rear														
1 rider	1.75 kg/cm ²	2.25 kg/cm ²														
Tire Size	100/80-16	110/70-16														

3. INSPECTION/ADJUSTMENT

SUPER8 50 2T

Inspection & Maintenance Item			Frequency				Judgment Standards	Remarks
			Prior	1st month	Every 6 months	Every 12 months		
Moving Device	Motor-cycle	Tire crack and damage	○		○	○		
		Tire groove and abnormal wear	○		○	○	Groove Depth: Front: 0.8mm Rear : 0.8mm	
		Imbedded objects, gravel, etc.	○		○	○		
		Axle nut looseness			○	○	Torque Values: Front axle nut 5.0~7.0kg-m Rear axle nut 11.0~13.0kg-m	Axle nut torque
		Check wheel rim, rim edge and spoke plate for damage		○		○	Rim runout at rim end: Front: Axial 2.0mm Radial 2.0mm Rear: Axial 2.0mm Radial 2.0mm	
		Check front wheel bearing for excessive play and abnormal noise				○		
		Check front wheel bearing for excessive play and abnormal noise				○		
Damping Device	Frame Spring	Damage					Shock spring free length	
	Suspension arm	Connecting parts looseness and arm damage				○		
	Shock absorber	Oil leakage and damage				○		
		Assembly parts looseness abnormal noise				○		
Power Drive System	Clutch	Operation		○	○	○		
	Transmission case	Oil leakage and oil level			○	○	Oil level: Oil check bolt hole at lower hole edge	Rear wheel transmission case
Electrical Equipment	Ignition device	Spark plug condition			○	○	Plug gap: 0.6~0.7mm	
	Battery	Terminal connection				○		
	Wires	Loose connection and damage				○		

3. INSPECTION/ADJUSTMENT

SUPER8 50 2T

Inspection & Maintenance Item			Frequency				Judgment Standards	Remarks
			Prior	1st month	Every 6 months	Every 12 months		
Engine	Body	Performance and abnormal noise			○	○		
		Conditions at low and high speeds		○	○	○		
		Exhaust smoke			○	○		
		Air cleaner			○	○		
	Lubrication system	Oil quality and quantity			○	○	<input type="checkbox"/> Oil level indicator Indicator light comes on when oil is insufficient	
		Oil leakage			○	○		
		Oil level	○					
		Check oil filter for clogging				○		
	Fuel System	Fuel leakage						
		Carburetor, throttle valve and auto bystarter				○		
		Check fuel filter for clogging				○		
		Fuel level	○					
		Fuel tube replacement					☆Every 4 years	
	Lights & Winker	Operation						
Winking action, dirt and damage		○						
Buzzer & Steering Lock	Operation				○			
Rearview Mirror & Reflector	Rearview mirror position	○					Rearview Mirror	
Reflector & License Plate	Dirt and damage	○						
Counter	Operation				○			
Exhaust Muffler	Joint looseness and damage				○			
	Exhaust muffler performance				○			
Body & Frame	Looseness and damage				○			
Abnormal Conditions Happened Last Time	Check if the abnormal conditions occur again	○						
Others	Lubrication points			○	○			
	Remove carbon deposits on combustion chamber, breather hole and exhaust muffler				○			

BRAKE SYSTEM

Inspect the brake fluid level.
Recommend brake fluid: DOT4

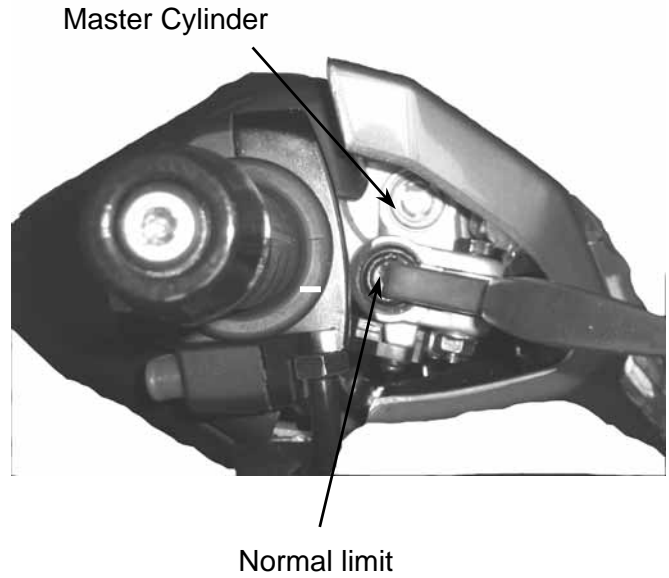

BRAKE LEVER

Measure the front and rear brake lever free plays.

Free Play: Rear: 10~20mm

Rear 10~20mm

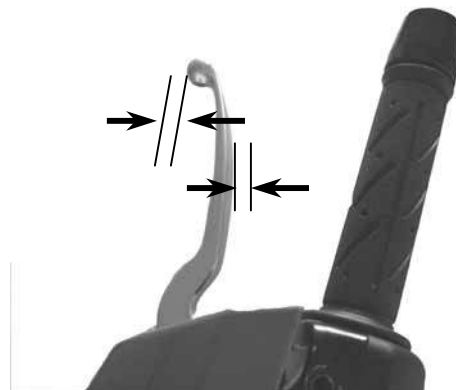

If the free plays do not fall within the limits, turn the right and left adjusting nuts for adjustment.

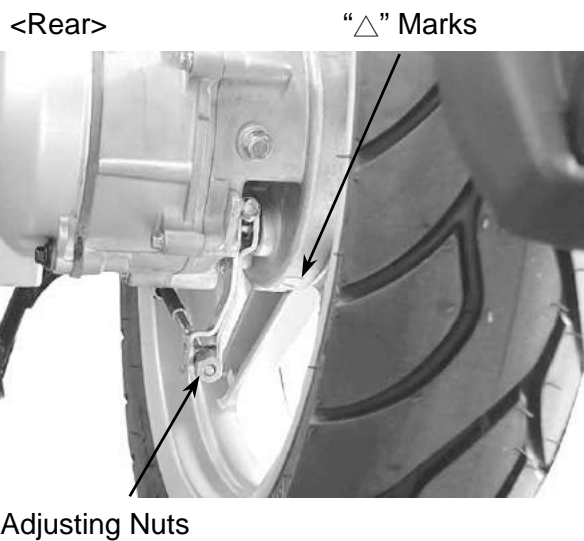

BRAKE DRUM/SHOE

《 Brake Shoe Wear 》

Replace the brake shoes if the arrow on the brake arm aligns with reference mark“△” on the brake panel when the brake is fully applied.

《 Brake Drum Wear/Damage 》

Check the brake drum appearance for damage. Check if the brake lining wear is within the specified service limit. Check the brake operation for abnormal noise and brake drum inside for wear or damage.

<Rear> “△” Marks

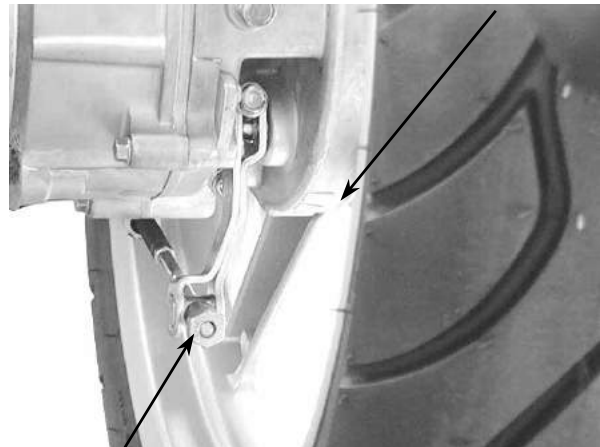

Adjusting Nuts

BRAKE DISK/LINING

《 Brake Disk Surface and Brake Pad Wear 》

Check the brake disk surface for scratch. Check if the brake pad wear is within the specified service limit.

《 Brake Disk Run-out Inspection 》

Stand the motorcycle wheels off the ground and check if the brake disk run-out is within the specified service limit.



Brake Disk

BRAKE FLUID LEVEL INSPECTION

《 Brake Master Cylinder Fluid Level Inspection 》

Turn the steering handlebar upright and check if the front brake fluid level is within the specified limits through the front brake master cylinder check hole.

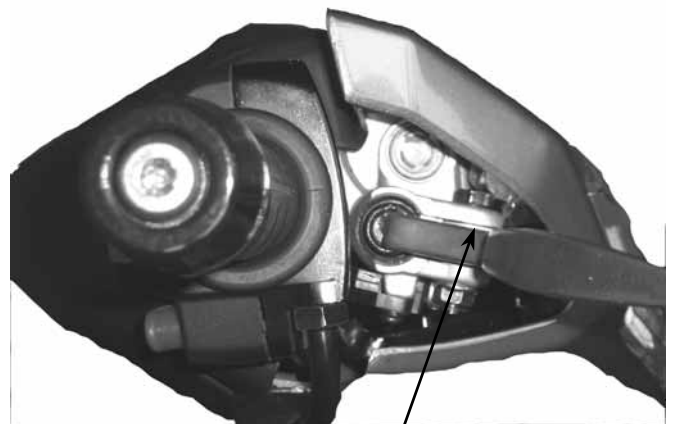

Brake Master Cylinder

MOVING DEVICE

TIRES

《Tire Pressure》

Check the tire pressure.

* Tire pressure should be checked when tires are cold.

Tire Pressure (one rider)

Front: 1.75 kg/cm²

Rear: 2.25 kg/cm²

Tire Size

Front	120/70 – 14 50P
Rear	120/80 – 14 52P



《Axle Nut/Axle Shaft Looseness》

Check the front and rear axle nuts for looseness.

If the axle nuts are loose, tighten them to the specified torques.

Torques:

Front: 5.0~7.0kg-m

Rear: 11.0~13.0kg-m

《Wheel Rim/Spoke Plate Damage》

Check the wheel rim and spoke plate for wear or damage and measure the rim runout.

Front Wheel



Axle Nut

Rear Wheel



Axle Nut

DAMPING DEVICE

SHOCK ABSORBERS

《Oil Leak/Damage》

Fully apply the front brake and check the action of the front shock absorber by compressing it several times.

Check the entire shock absorber assembly for looseness or damage.

Check the action of the rear shock absorber by compressing it several times.

Check the entire shock absorber assembly for looseness or damage.



POWER DRIVE SYSTEM

TRANSMISSION CASE

Check the rear wheel transmission case surrounding area for oil leaks.

Stop the engine and remove the oil check bolt.

* Place the motorcycle on its main stand on level ground.



The gear oil level shall be at the oil check bolt hole. If the oil level is low, add the specified oil to the proper level.

Specified Gear Oil: SAE 90#

Install and tighten the oil check bolt.

Torque: 1.0~1.5kg-m

Start the engine and check for oil leaks.

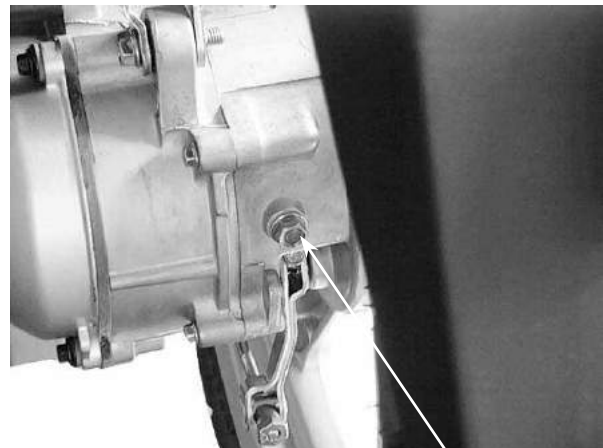

Oil Check Bolt

ELECTRICAL EQUIPMENT

IGNITION APPARATUS

《Spark Plug》

Remove the frame center cover.
 Remove the spark plug cap and spark plug.
 Check the spark plug for wear, fouling and carbon deposits.
 Remove the fouling and carbon deposits with a spark plug cleaner or wire brush.

Specified Spark Plug

NGK
SF10JA
BR8HSA

Spark Plug Gap: 0.6~0.7mm

《Ignition Apparatus》

* The CDI ignition timing is not adjustable. If the timing is incorrect, check the CDI unit, ignition coil and A.C. generator and replace any faulty parts.

Remove the right side rail. (⇒12-4)
 Remove the A.C. generator fan cover.
 (⇒7-3)
 Remove the three bolts attaching the fan cover and then remove the fan cover.
 Warm up the engine and check the ignition timing with a timing light.

When the engine is running at the specified rpm, the ignition timing is correct if the "F" mark on the flywheel aligns with the index mark on the crankcase within $\pm 1.5^\circ$.

Ignition Timing:

$13.5^\circ \pm 1^\circ$ BTDC/2000rpm

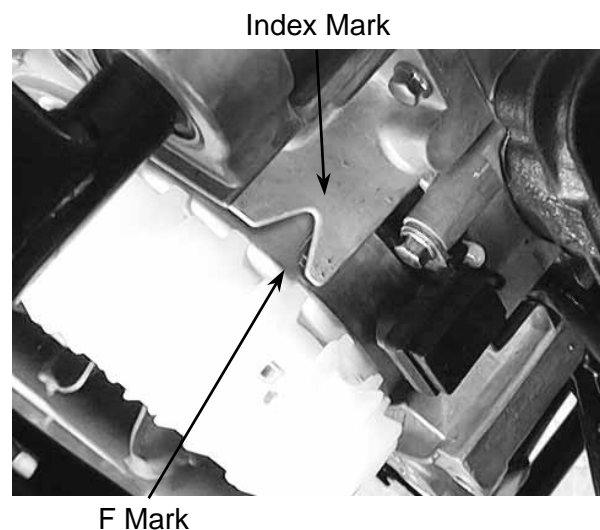
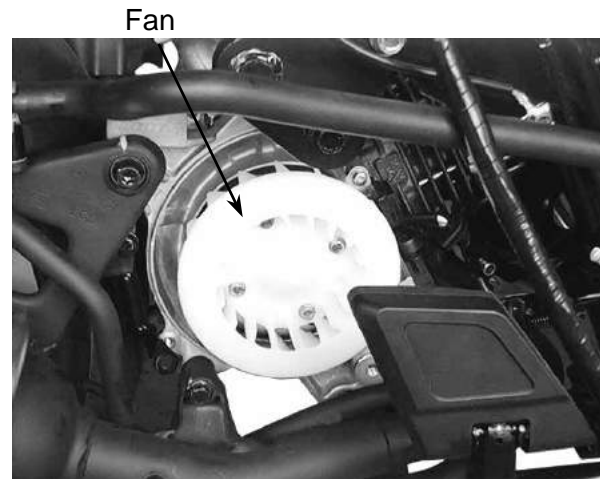
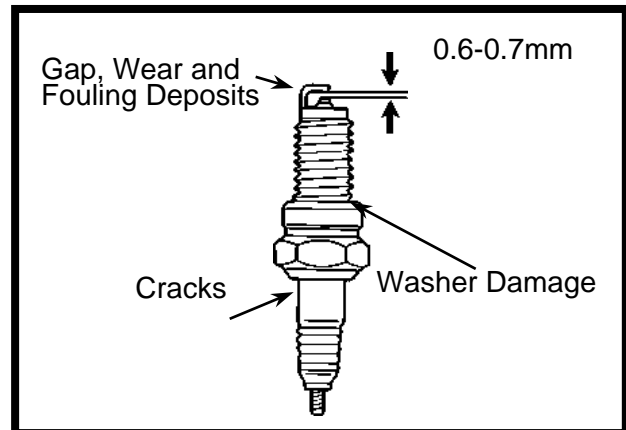

ENGINE

BODY

《At High and Low Speeds》

* The engine must be warm for accurate idle speed adjustment.

Adjust the idle speed to the specified range by turning the throttle stop screw and air screw.

Idle Speed:

1850±100rpm

《Air Cleaner》

Remove the air cleaner cover by removing the five bolts cleaner cover screws.

Remove the air cleaner element.

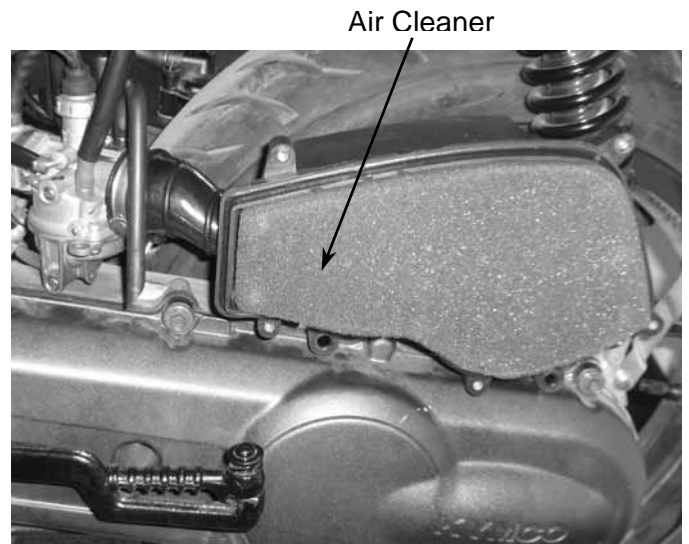
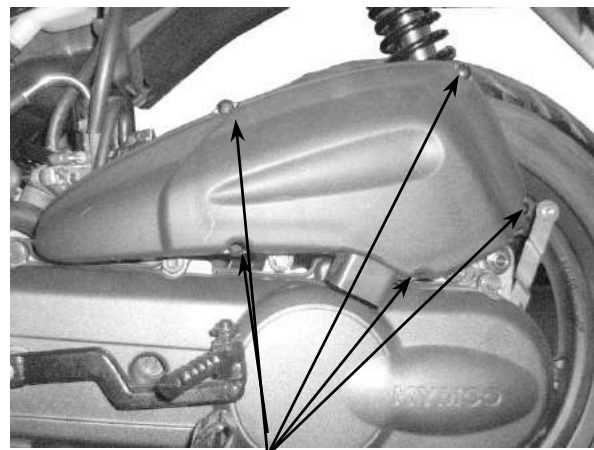
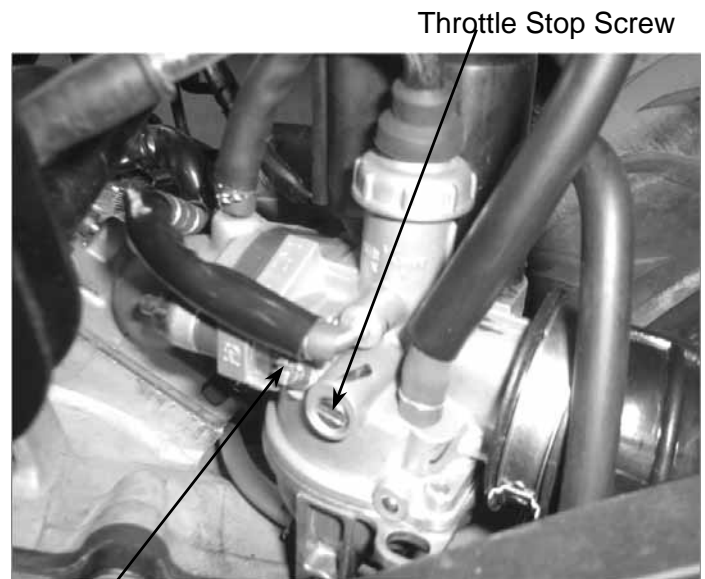

Wash the air cleaner element in detergent oil, squeeze out and allow to dry.

* Never use gasoline or organic vaporable oil with acid or alkali for washing.

After washing, soak the element in clean engine oil SAE 10W-30# and squeeze out excess oil. Reinstall the element.

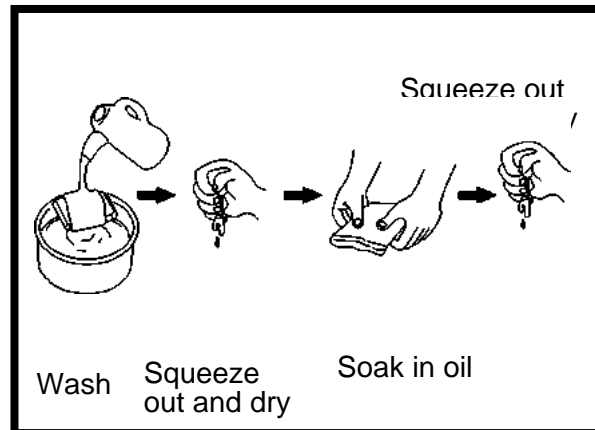

《Cylinder Compression》

* Warm up the engine before compression test.

Remove the spark plug and insert a compression gauge.

Open the throttle valve fully and push the starter button for 7~8 seconds to test the compression.

Compression:

11.8kg/cm²

If the compression is low, check for the following:

- Leaking cylinder head gasket
- Worn piston/cylinder

If the compression is high, it indicates that carbon deposits have accumulated on the combustion chamber and the piston head.



LUBRICATION SYSTEM

《Oil Filter Cleaning》

Disconnect the oil tube at the oil pump side and allow oil to drain into a clean container. Remove the tube clip at the oil tank side and disconnect the oil tube. Remove the oil filter.

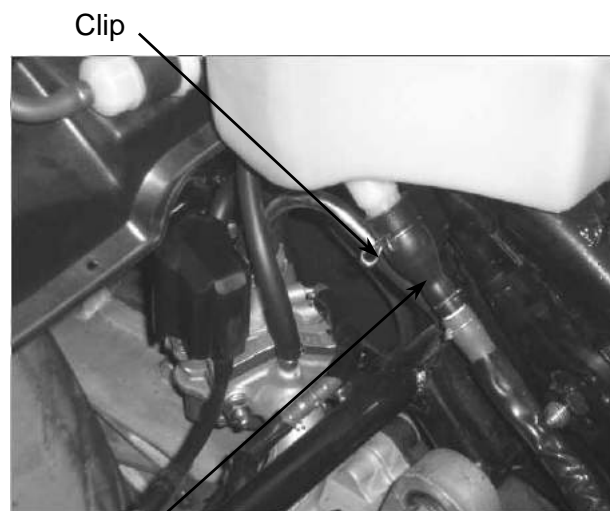

Oil Filter

Clean the oil filter screen with compressed air.

Install the oil filter in the reverse order of removal and fill the oil tank with specified oil up to the proper level.

Bleed air from the oil pump and oil lines.

*

- Connect the oil tubes securely.
- Install the tube clip at the oil tank side and also install the clip to the lower oil tube that goes to the oil pump.
- Check for oil leaks.

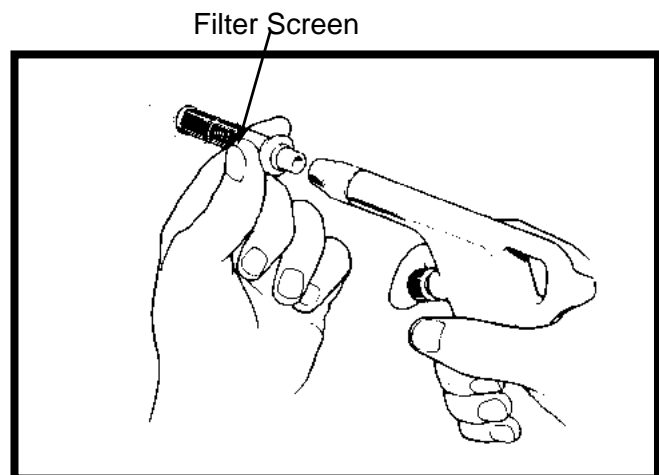

《Oil Pump Condition》

*

Adjust oil pump control cable after the throttle grip free play is adjusted.

Open the throttle valve fully and check that the index mark on the pump body aligns with the aligning mark on the oil pump control lever.

Reference tip alignment within 1mm of index mark on open side is acceptable.

Start and idle the engine, then slowly open the throttle to increase engine rpm and check the operation of the oil pump control lever.

If adjustment is necessary, adjust the oil pump control cable by loosening the control cable lock nut and turning the adjusting nut. After adjustment, tighten the lock nut.

*

Reference tip alignment within 1mm of index mark on open side is acceptable. However, the aligning mark on the control lever must never be on the closed side of the index mark, otherwise engine damage will occur because of insufficient lubrication.

Lock Nut Control Lever Aligning Mark

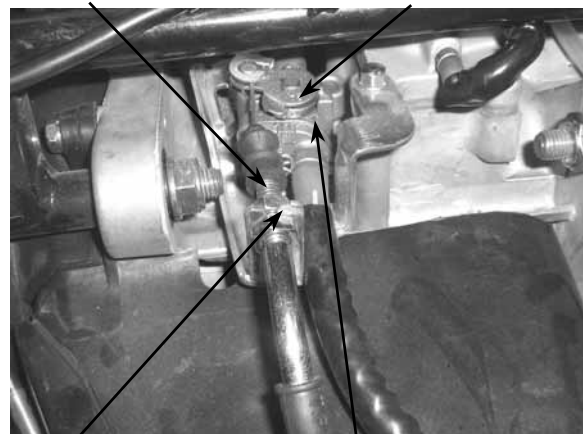

Adjusting Nut Pump Body Index Mark

If the oil pump is not synchronized properly, the following will occur:

- Excessive white smoke or hard starting due to pump control lever excessively open
- Seized piston due to pump control lever insufficiently open.

FUEL SYSTEM

《Throttle Grip Free Play》

Measure the throttle grip free play.

Free Play: 2~6mm



If the throttle grip free play does not fall within the specified range, adjust by loosening the lock nut and turning the adjusting nut.

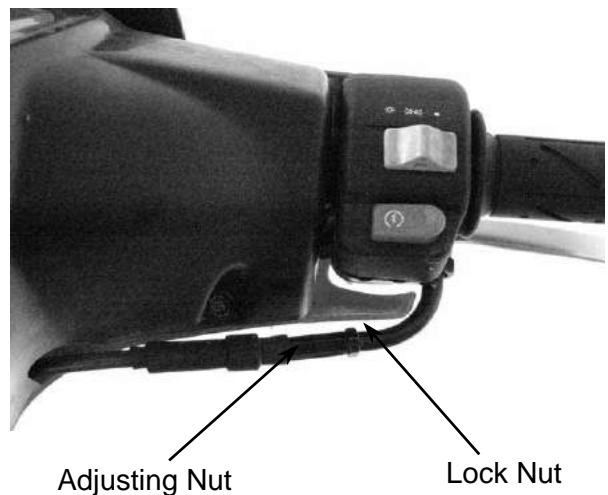

OTHERS

LIGHTS

《Headlight》

Front upper cover remove. (12—5)

Adjust the headlight beam by loosening the headlight adjusting bolt and moving the adjusting bolt forward and backward to a proper position. Tighten the adjusting bolt.

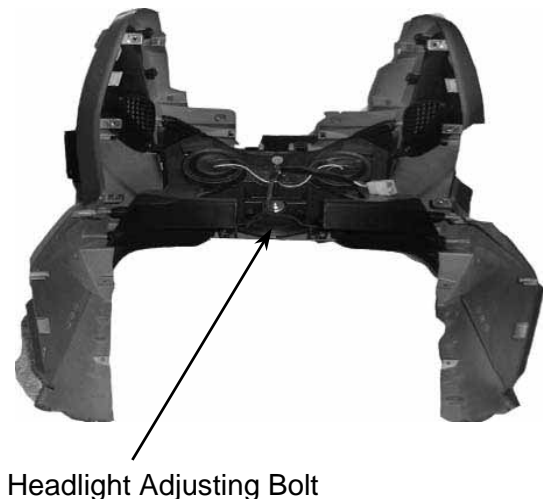

LUBRICATION SYSTEM

SERVICE INFORMATION 4-2

TROUBLESHOOTING 4-2

OIL PUMP REMOVAL 4-3

OIL PUMP INSPECTION 4-3

OIL PUMP INSTALLATION 4-4

OIL PUMP BLEEDING 4-5

OIL TANK 4-6

LUBRICATION SYSTEM

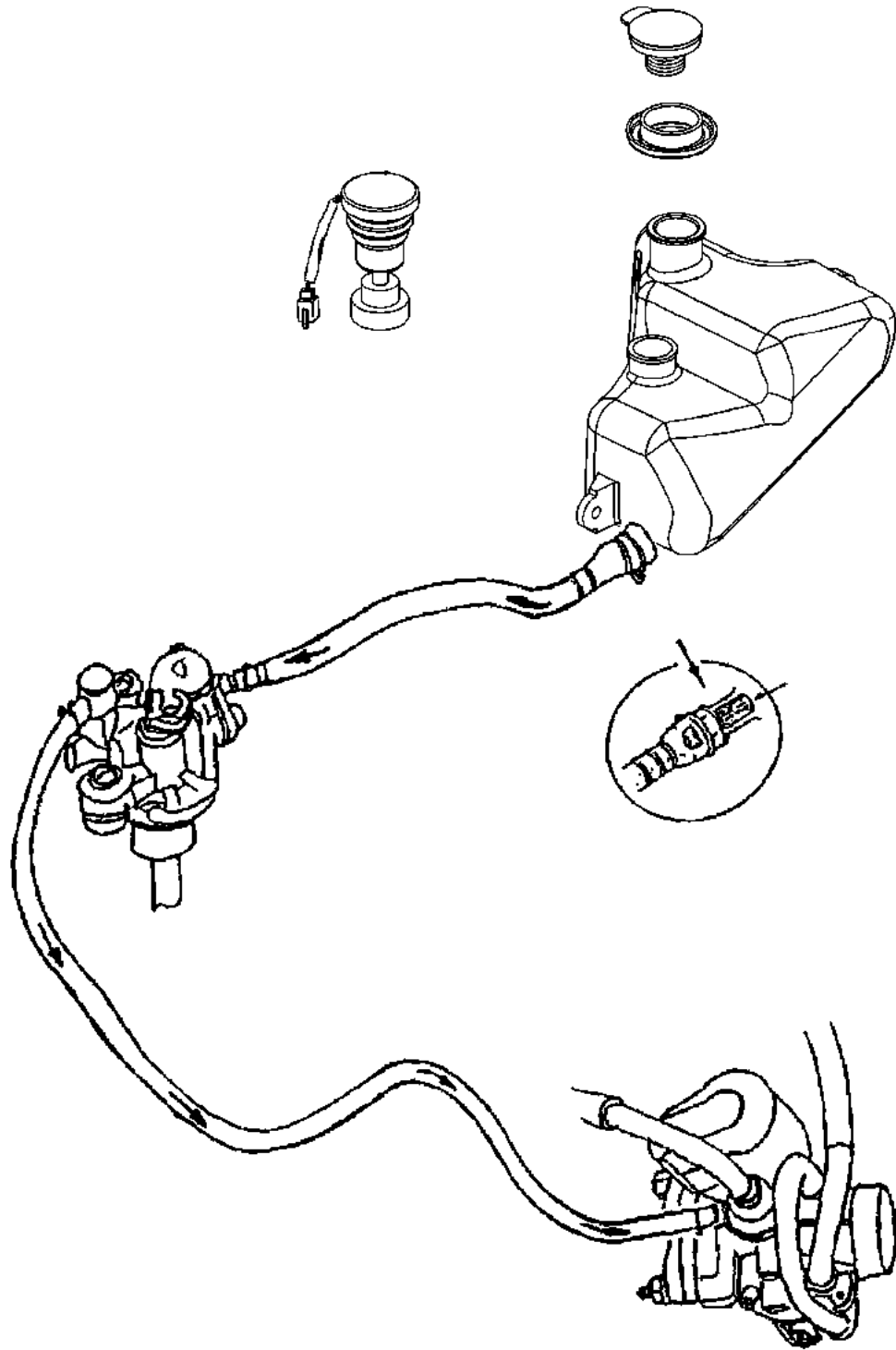

SERVICE INFORMATION

GENERAL INSTRUCTIONS

- Use care when removing and installing the oil pump not to allow dust and dirt to enter the engine and oil line.
- Do not attempt to disassemble the oil pump.
- Bleed air from the oil pump if there is air between the oil pump and oil line.
- If the oil is disconnected, refill the oil line with motor oil before connecting it.

SPECIFICATIONS

- Recommended Motor Oil: 2-stroke Motor Oil
- Oil Capacity : 1.1 liter
Light comes on : 0.5 liter

TROUBLESHOOTING

Excessive white smoke or carbon deposits on spark plug

- Oil pump not properly synchronized (excessive oil)
- Poor quality oil

Engine overheating

- Oil pump not properly adjusted (insufficient oiling)
- Poor quality oil

Seized piston

- No oil in tank or clogged oil line
- Oil pump not properly adjusted (insufficient oiling)
- Air in oil line
- Faulty oil pump

Oil not flowing out of tank to engine

- Clogged oil tank cap breather hole
- Clogged oil filter

OIL PUMP REMOVAL

*

Do not allow foreign matters to enter the crankcase. Before removing the oil pump, clean the oil pump and crankcase surfaces.

Remove the met-in box. (⇒12-4)

Disconnect the oil pump control cable from the pump body.
Disconnect the oil inlet line from the oil pump.
Then, disconnect the oil outlet line.

*

Before disconnecting the oil line, clip the oil line to avoid oil flowing out and then plug the oil line after it is disconnected.

Remove the oil pump control cable plate bolt.
Remove the oil pump from the crankcase.

OIL PUMP INSPECTION

Remove the oil pump and inspect the following items:

- Weakened O-ring
- Damage to crankcase mating surface
- Damage to pump body
- Control lever operation
- Oil leaks through oil seals
- Worn or damaged pump pinion

*

Do not disassemble the oil pump which cannot be used after disassembly.

Oil Pump

Control Cable

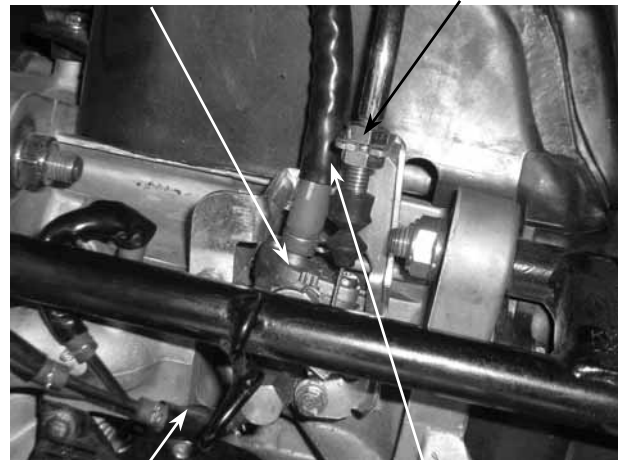

Oil Outlet Line

Oil Inlet Line

Control Cable Plate

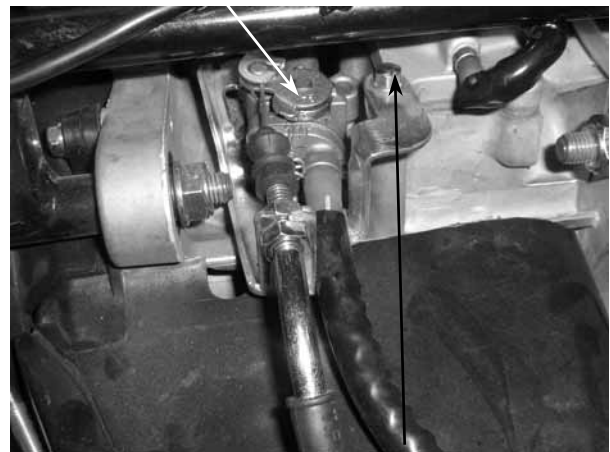

Bolt

O-ring

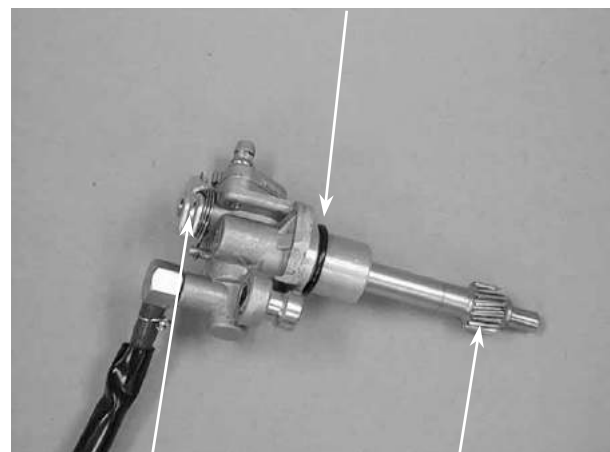

Control Lever

Pinion

OIL PUMP INSTALLATION

* _____

- Lubricate the O-ring with grease or engine oil before installation.
- Make sure that the oil pump is inserted into the crankcase.
- Apply molybdenum disulfide or grease to the pump pinion.

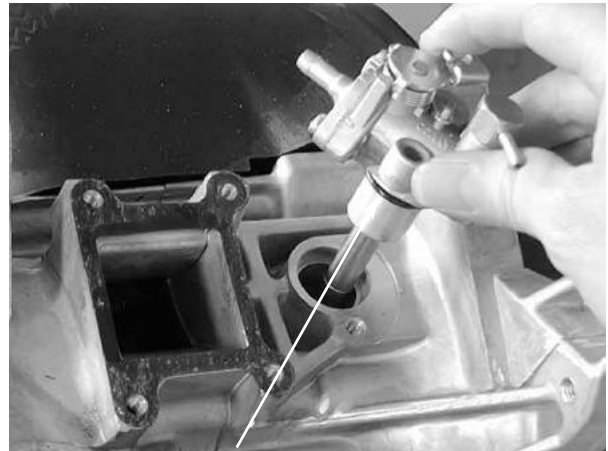

Grease or Engine Oil

Install the oil pump onto the crankcase.

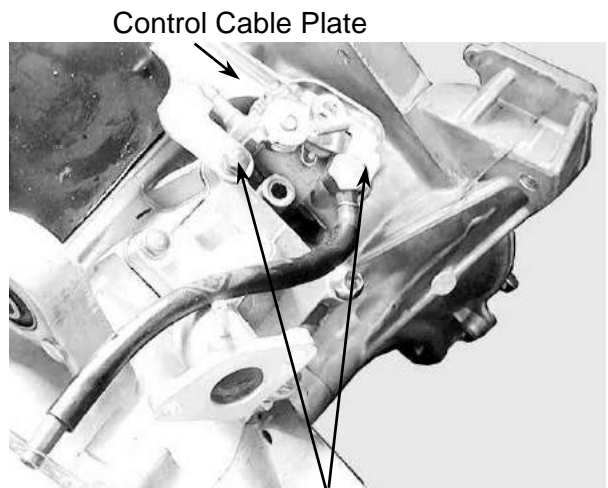

Control Cable Plate

Bolts

Install the oil pump control cable plate.
Connect the oil inlet line and oil outlet line properly.
Connect the oil pump control cable.
Bleed air from the oil pump.

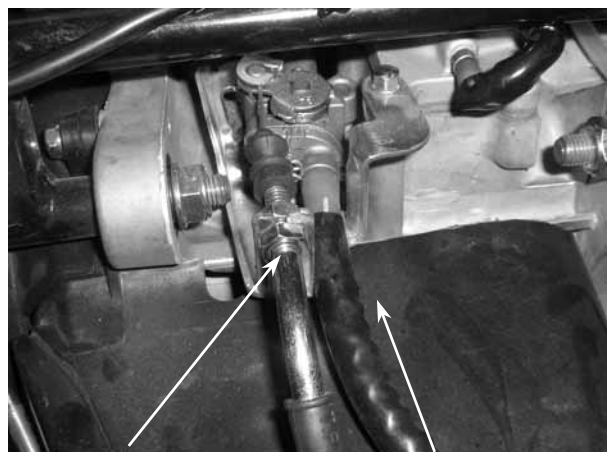

Control Cable

Oil Inlet Line

OIL PUMP BLEEDING

★

- Air in the oil lines will block oil flow and result in severe engine damage.
- Bleed air from the oil lines and oil pump whenever the oil lines or pump have been removed or there is air in the oil lines.

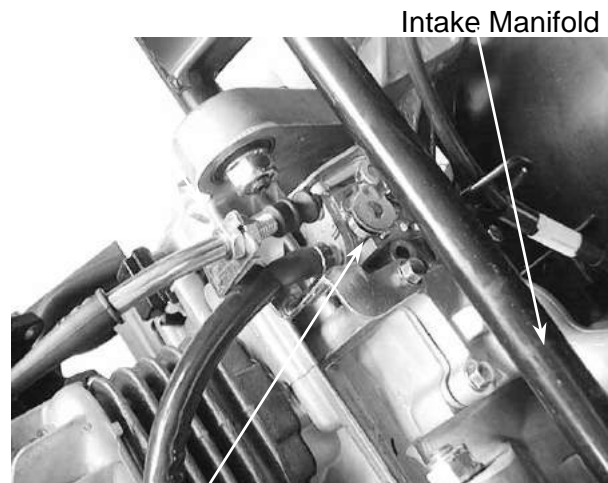

Oil Pump

OIL INLET LINE/OIL PUMP BLEEDING

Fill the oil tank with recommended oil.
Place a shop towel around the oil pump.
Disconnect the oil inlet line from the oil pump and clip it.
Fill the oil pump with oil by squirting clean oil through the joint. (About 3cc)
Fill the oil line with oil and connect it to the oil pump.

★

Bleed air from the oil inlet line first, then bleed air from the oil outlet line.

OIL OUTLET LINE BLEEDING

1. Disconnect the oil outlet line and bend it into U shape. Force air out of the tube by filling it with oil.
2. Start the engine and allow it to idle with the oil control lever in the fully open position. Visually check the oil flow.
3. If there is no oil flowing out within 1 minute, bleed air from the oil inlet line and oil pump.

★

- Never run the engine in a closed area.
- Do not increase the engine speed at will.

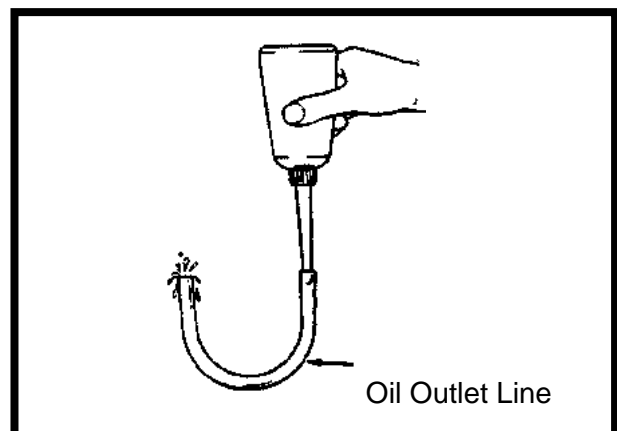

Oil Tube

OIL TANK

OIL TANK REMOVAL

- Remove the met-in box. (⇒12-5)
- Remove the frame body cover. (⇒12-5)
- Remove the rear carrier. (⇒12-5)
- Remove the oil meter connector.
- Remove the two bolts attaching the oil tank.
- Disconnect the oil inlet line.
- Drain the oil inside the oil tank into a clean container.
- Remove the oil tank.
- The installation sequence is the reverse of removal.

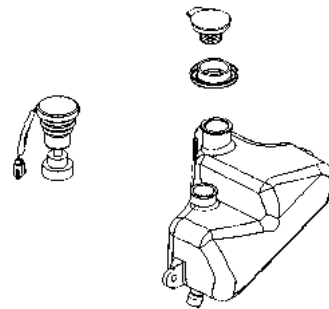
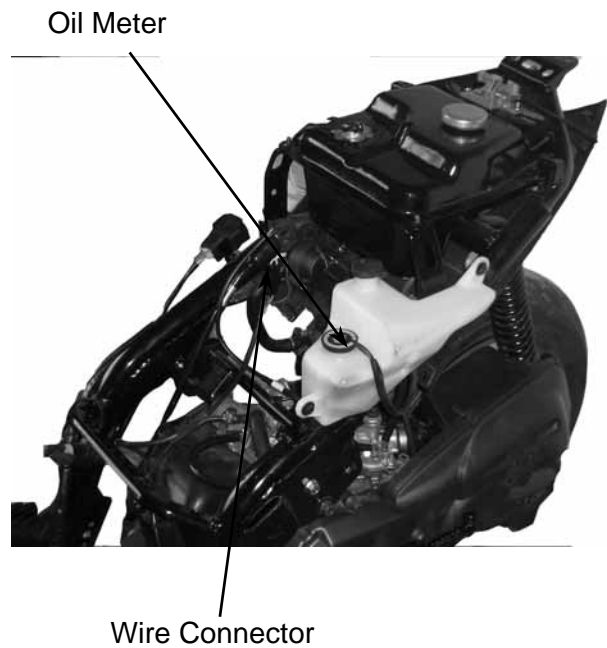

*

- Connect the oil line properly.
- Bleed air from the oil pump after installation.
- The oil tube clip (at the oil tank side) must be locked from inside of the oil tube joint.

ENGINE REMOVAL/INSTALLATION

SERVICE INFORMATION 5-1
ENGINE REMOVAL..... 5-2
ENGINE INSTALLATION..... 5-4

SERVICE INFORMATION

GENERAL INSTRUCTIONS

- A floor jack or other adjustable support is required to support and maneuver the engine. Be careful not to damage the motorcycle body, cables and wires during engine removal.
- Use shop towels to protect the motorcycle body during engine removal.
- Parts requiring engine removal for servicing:
 - Crankcase
 - Crankshaft

TORQUE VALUES

Engine mounting bolt	4.5~5.5kg-m
Rear shock absorber lower mount bolt	2.4~3.0kg-m
Engine hanger bracket bolt	3.5~4.5kg-m

ENGINE REMOVAL

Remove the frame body cover. (⇒12-5)
Remove the five bolts attaching the air cleaner case.
Loosen the band between the air cleaner and carburetor to remove the air cleaner case.
Remove the carburetor cap.

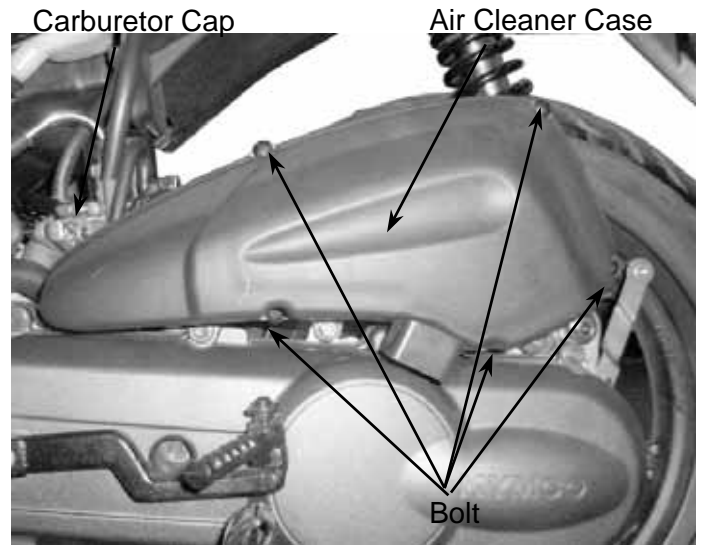

Disconnect the auto bystarter, A.C. generator and starter motor wire connectors.

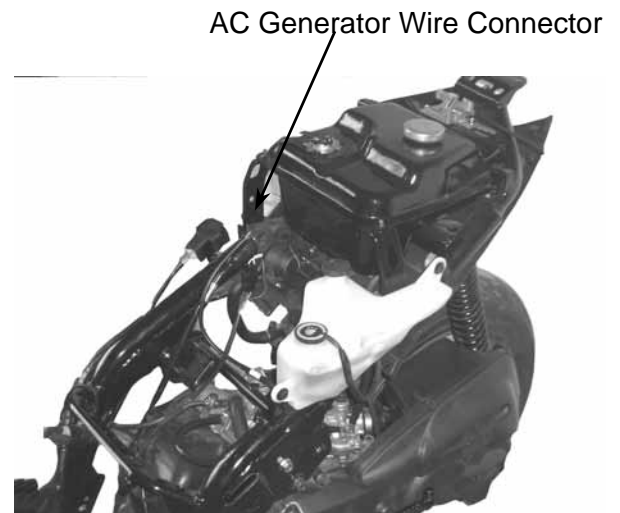

Disconnect the oil pump control cable from the pump body.
Disconnect the oil inlet line from the oil pump.
Remove the spark plug cap.

* After the oil inlet line is disconnected, plug the oil line opening to prevent oil from flowing out.

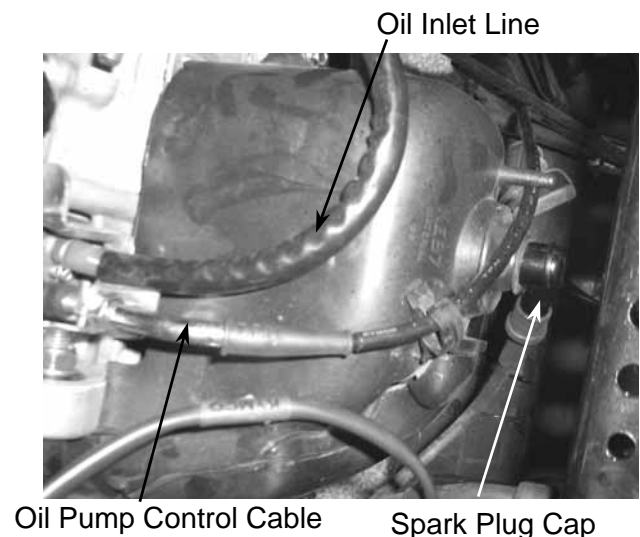

Remove the rear brake adjusting nut and disconnect the brake cable from the crankcase.
Remove the rear brake cable clamp and rear brake cable.
Remove the rear shock absorber lower mount bolt.

Rear Shock Absorber Lower Mount Bolt

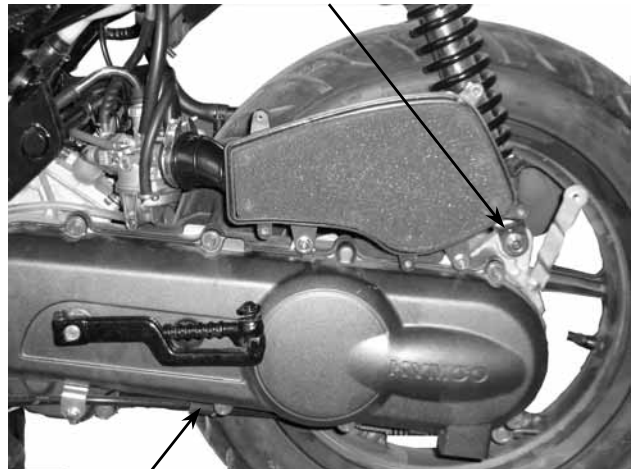

Rear Brake Cable

Remove the right and left engine mounting nuts.
Take out the right and left engine mounting bolts.
Lift the frame upward to separate it from the engine and be careful not to damage the rear fender.

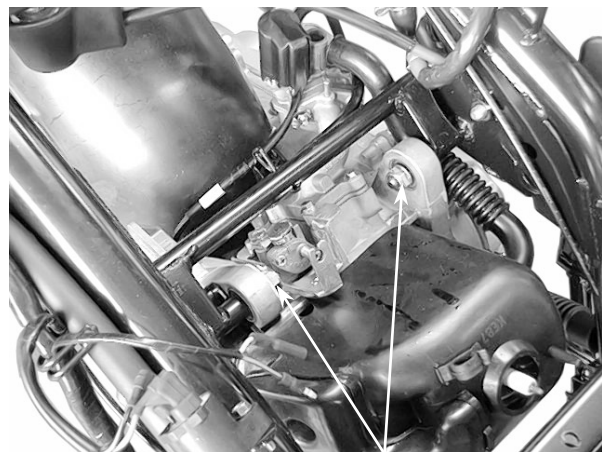

Engine Mounting Nuts

ENGINE HANGER BRACKET REMOVAL

Remove the engine hanger bracket bolt and engine hanger bracket.
The installation sequence is the reverse of removal.

Torque: 3.5~4.5kg-m

Engine Hanger



Engine Hanger Bracket Bolt

ENGINE HANGER BRACKET INSPECTION

Inspect the stopper rubbers and bushings for damage and replace with new ones if necessary.

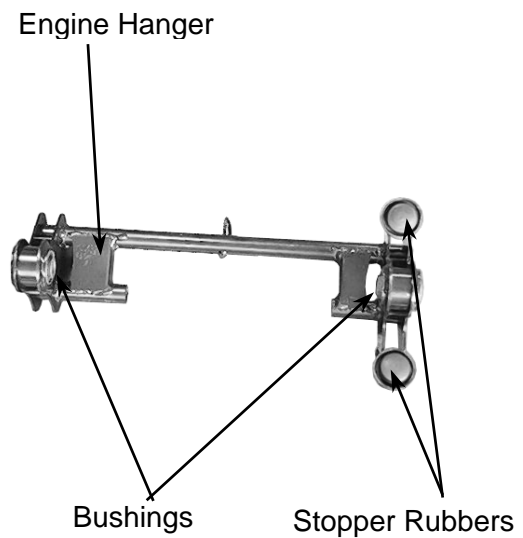

ENGINE INSTALLATION

Install the engine in the reverse order of removal.

* Cables and wires should be routed properly.

Torque Values:

Engine mounting bolt : 4.5~5.5kg-m

Rear shock absorber lower mount bolt:
: 2.4~3.0kg-m



Perform the following inspections and adjustments after installation.

- Throttle cable
- Oil pump control cable (⇒3-11)
- Rear brake cable (⇒3-5)
- Oil pump bleeding (⇒3-11)

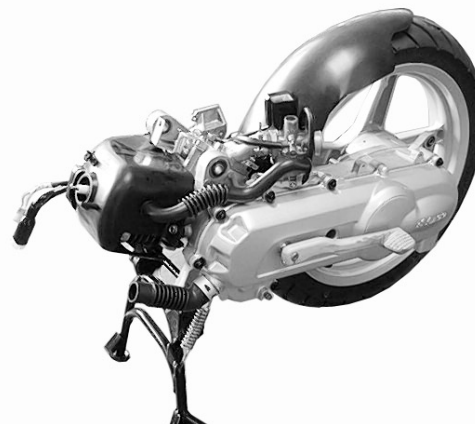

CYLINDER HEAD/CYLINDER/PISTON

SERVICE INFORMATION 6-2
TROUBLESHOOTING 6-2
CYLINDER HEAD 6-3
CYLINDER/PISTON 6-6

Torque: 1.1~1.7kg-m (cold)

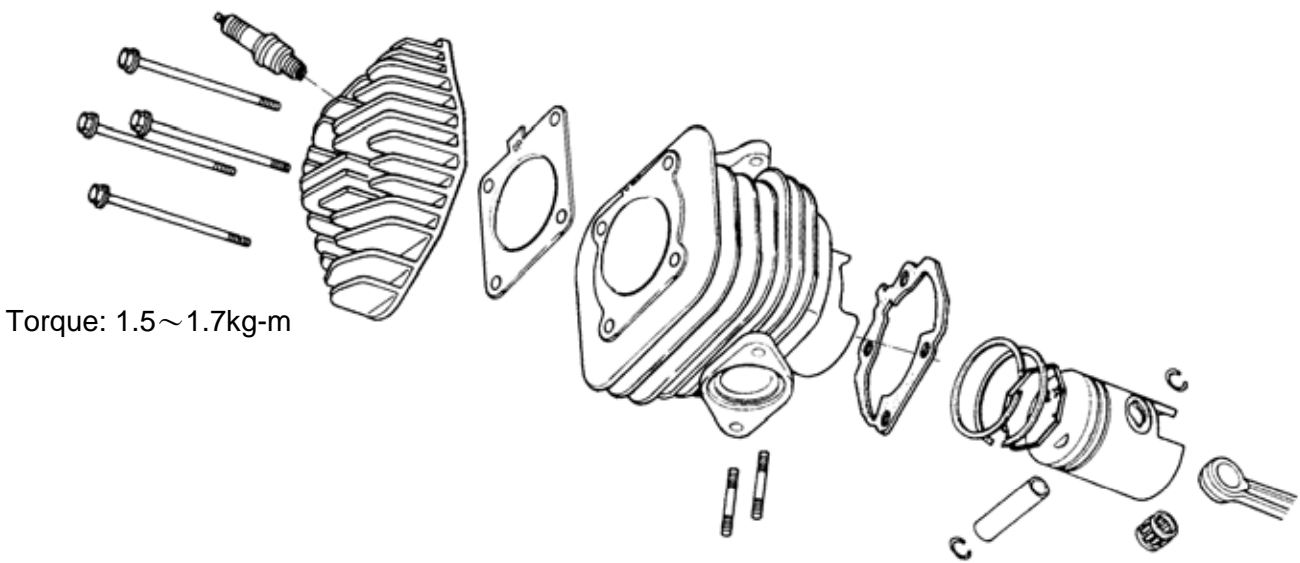

SERVICE INFORMATION

GENERAL INSTRUCTIONS

- The cylinder head, cylinder and piston can be serviced with the engine installed in the frame.
- Before disassembly, clean the engine to prevent dust from entering the engine.
- Remove all gasket material from the mating surfaces.
- Do not use a driver to pry between the cylinder and cylinder head, cylinder and crankcase.
- Do not damage the cylinder inside and the piston surface.
- After disassembly, clean the removed parts before inspection. When assembling, apply the specified engine oil to movable parts.

SPECIFICATIONS

Item	Standard (mm)	Service Limit (mm)
	SUPER8 50 2T	SUPER8 50 2T
Cylinder head warpage	—	0.10
Piston O.D.(5mm from bottom of piston skirt)	38.970~38.955	38.90
Cylinder-to- piston clearance		0.10
Piston pin hole I.D.	12.002~12.008	12.03
Piston pin O.D.	11.994~12.0	11.98
Piston-to-piston pin clearance	←	←
Piston ring end gap (top/second)	0.10~0.25	0.40
Connecting rod small end I.D.	17.005~17.017	17.03
Cylinder bore	39.0~39.025	39.05

TORQUE VALUES

Cylinder head bolt	1.5~1.7kg-m
Exhaust muffler joint lock nut	1.8~2.2kg-m
Exhaust muffler lock bolt	3.0~3.6kg-m
Spark plug	1.1~1.7kg-m

●TROUBLESHOOTING

Compression too low, hard starting or poor performance at low speed

- Leaking cylinder head gasket
- Loose spark plug
- Worn, stuck or broken piston and piston rings
- Worn or damaged cylinder and piston

Compression too high, overheating or knocking

- Excessive carbon build-up in cylinder head or on piston head

Abnormal noisy piston

- Worn cylinder and piston
- Worn piston pin or piston pin hole
- Worn connecting rod small end bearing

Abnormal noisy piston rings

- Worn, stuck or broken piston rings
- Worn or damaged cylinder

CYLINDER HEAD

REMOVAL

Remove the rear carrier.
Remove the frame body cover. (⇒12-5)
Remove the spark plug cap.

Spark Plug Cap

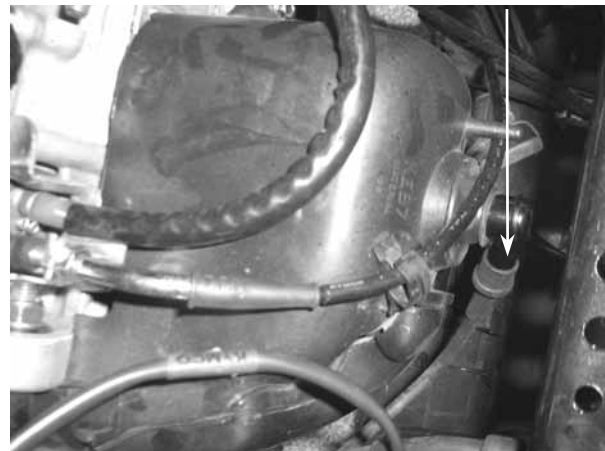

Remove the three bolts attaching the fan cover to remove the fan cover.
Remove the two joint lock nuts on the front of the exhaust muffler and then remove the two exhaust muffler lock bolts.
Remove the bolt attaching the engine hood to remove the engine hood.
The installation sequence is the reverse of removal.

Fan Cover/Engine Hood

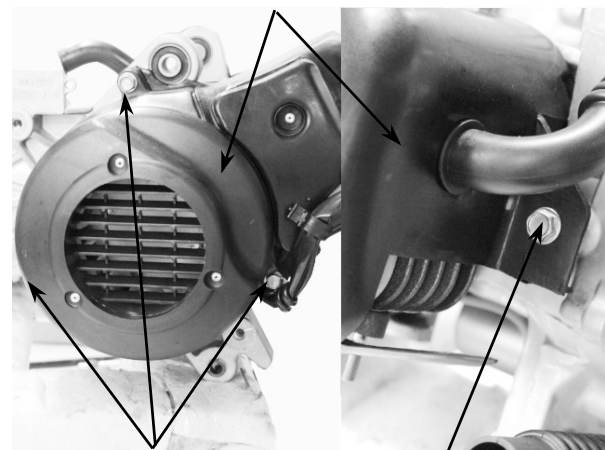

* When installing the exhaust muffler, first tighten the two nuts on the front and then tighten the two bolts.

Bolts

Bolt

Remove the spark plug.
Remove the cylinder head bolts and the cylinder head.

* Loosen the bolts diagonally in 2 or 3 times.

Cylinder head Bolts

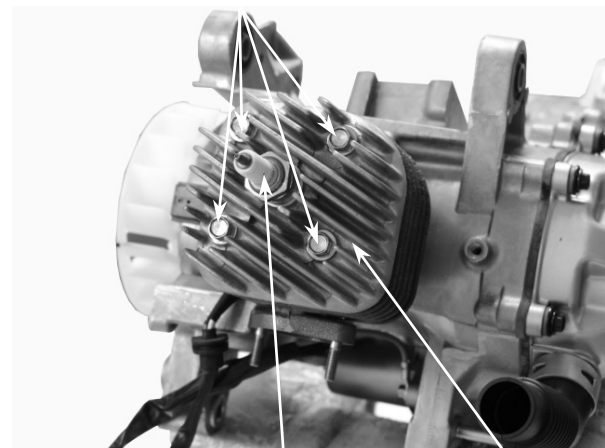

Spark Plug

Cylinder Head

COMBUSTION CHAMBER DECARBONIZING

Remove the carbon deposits from the combustion chamber

* Avoid damaging the combustion chamber wall and cylinder mating surface.

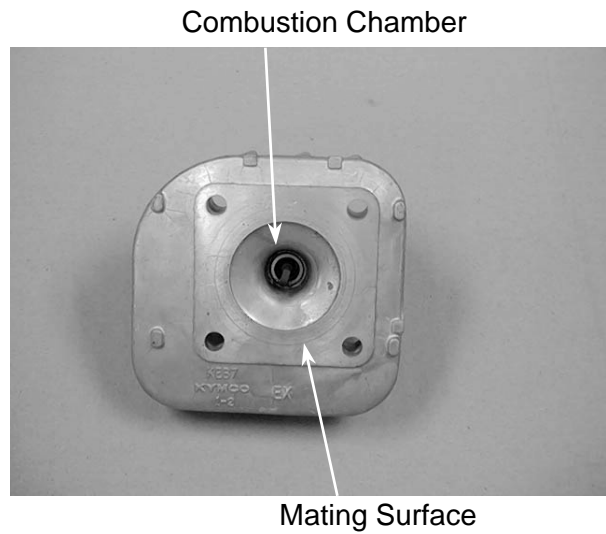

CYLINDER HEAD INSPECTION

Check the cylinder head for warpage with a straight edge and feeler gauge.

Service Limit:

0.10mm replace if over

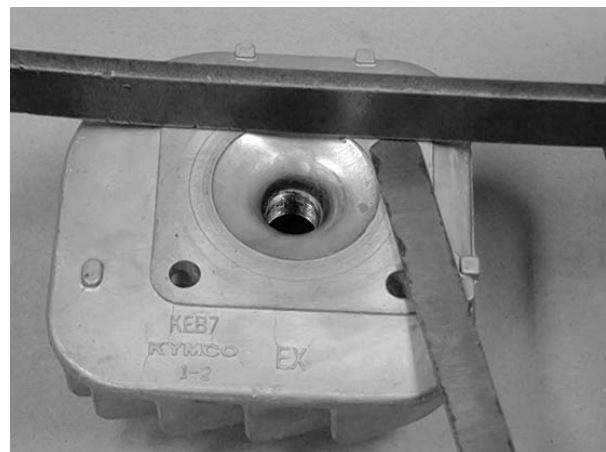

CYLINDER HEAD INSTALLATION

Install the cylinder head on the cylinder properly.

* Be careful not to damage the mating surfaces.

Install a new cylinder head gasket onto the cylinder.

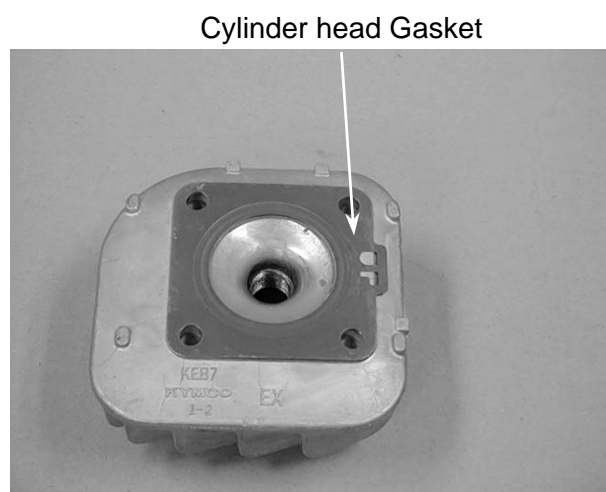

Cylinder Head Bolts Installation

Install and tighten the cylinder head bolts diagonally in 2 or 3 times.

Torque: 1.5~1.7kg-m

Install the spark plug.

Torque: 1.1~1.7kg-m

Cylinder head Bolts

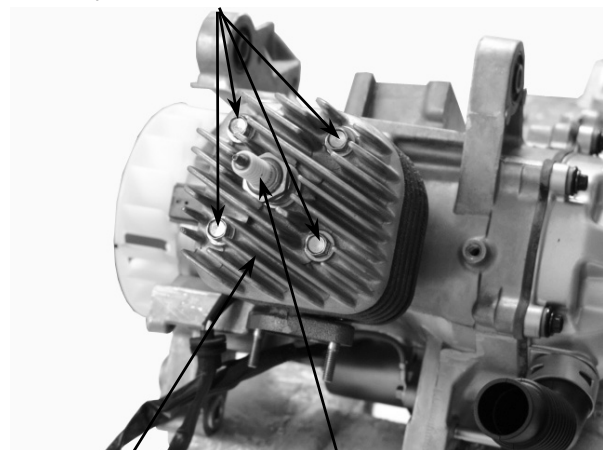

Cylinder Head Spark Plug

Engine Hood Installation

Install the engine hood. (⇒6-3)

Install the spark plug cap. (⇒6-3)

Engine Hood

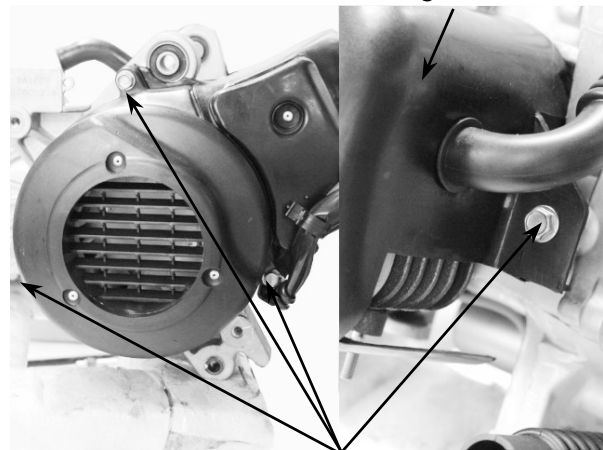

Bolts

Perform the following inspections after installation:

- Compression test
- Abnormal engine noise
- Cylinder air leaks



CYLINDER/PISTON

CYLINDER REMOVAL

- Remove the met-in box and seat.
- Remove the frame body cover.
- Remove the cylinder head.
- Remove the two exhaust muffler joint lock nuts and two exhaust muffler lock bolts.
- Remove the exhaust muffler.
- Remove the cylinder.
- Remove the cylinder gasket.

*

Do not pry between the cylinder and crankcase or strike the fins.

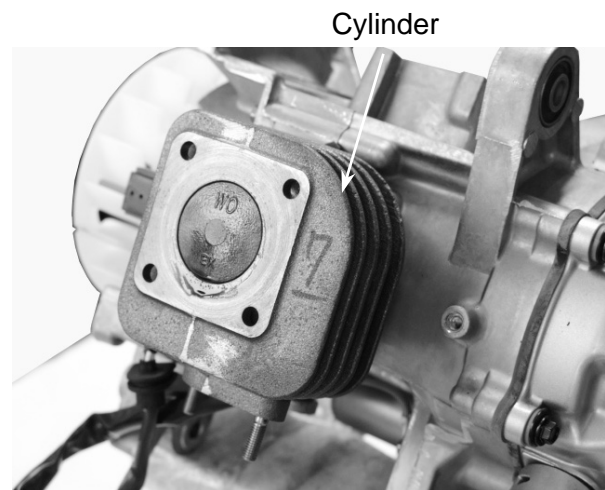

PISTON REMOVAL

- Remove the piston pin clip to remove the piston pin and piston.

*

- Do not damage or scratch the piston.
- Do not apply side force to the connecting rod when removing the piston pin.
- Place clean shop towels in the crankcase to keep the piston pin clip from falling into the crankcase.

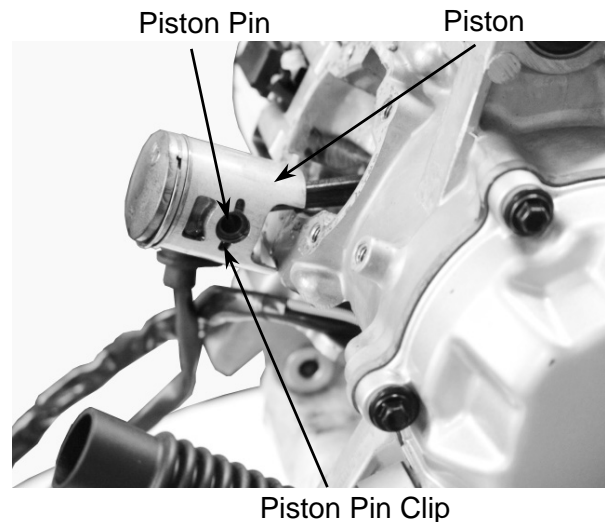

- Spread each piston ring and remove by lifting it up at a point just opposite the gap.
- Remove the expander.



CYLINDER/PISTON INSPECTION

Check the cylinder and piston for wear or damage.
Clean carbon deposits from the exhaust port area.

* Be careful not to damage the cylinder inside wall.



Measure the cylinder bore at three levels of A, B and C in both X and Y directions. Avoid the port area. Take the maximum figure measured to determine the cylinder bore.

Service Limit:

39.05mm replace if over

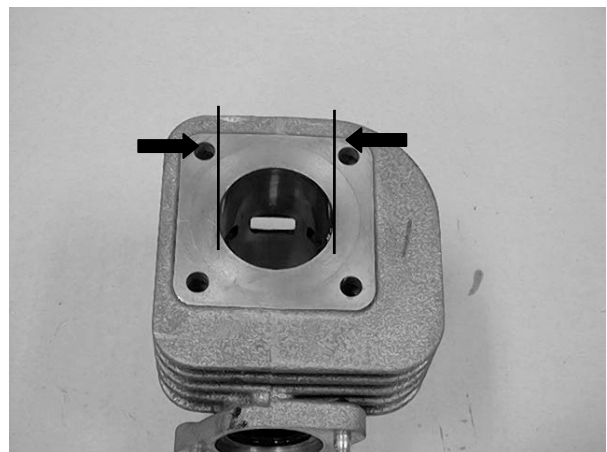

Inspect the top of the cylinder for warp.

Service Limit:

0.10mm replace if over



* The cylinder has an 'A' mark or no mark on it. When replacing the cylinder with a new one, use a cylinder having the same mark as the old one.

A Mark

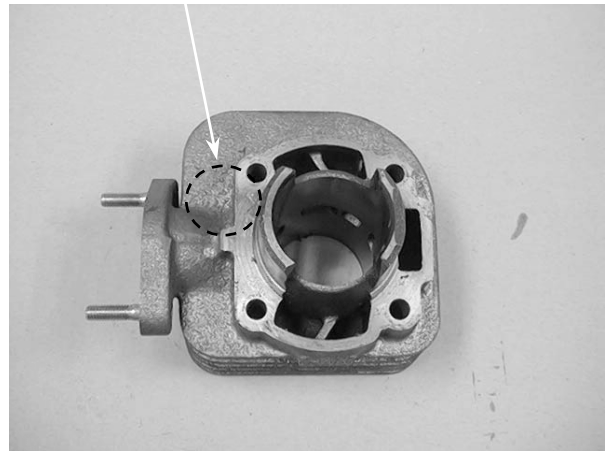

Measure the piston O.D. at a point 5mm from the bottom of the piston skirt.

Service Limit:
38.90mm replace if below

Measure the piston-to-cylinder clearance.

Service Limit:
0.10mm replace if over

Measure the piston pin hole I.D.

Service Limit:
12.03mm replace if over

Measure the piston pin O.D.

Service Limit:
11.98mm replace if below

Measure the piston-to-piston pin clearance.

Service Limit:
0.03mm replace if over

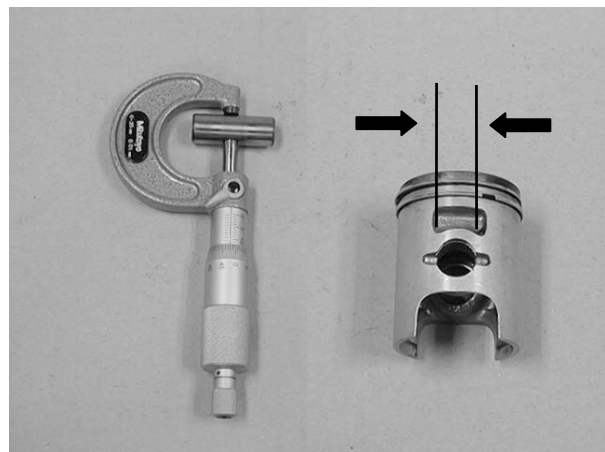
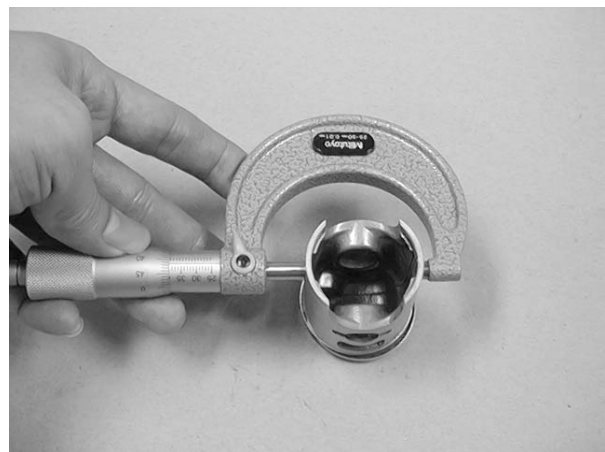

PISTON RING INSPECTION

Measure each piston ring end gap.

Service Limits: Top/Second

0.40mm replace if over

* Set each piston ring squarely into the cylinder using the piston and measure the end gap.

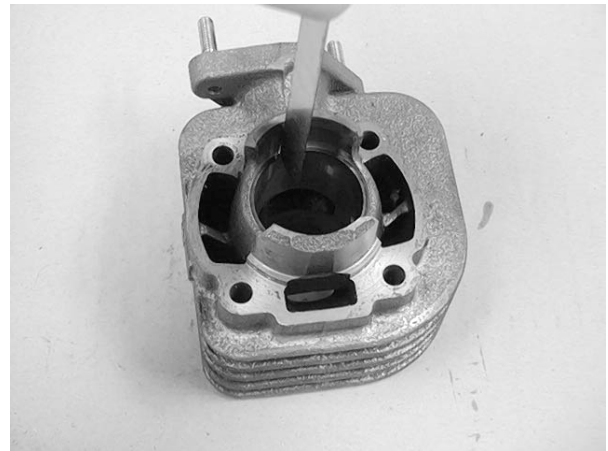

<Small End I.D. Measurement>

CONNECTING ROD SMALL END INSPECTION

Install the piston pin and bearing in the connecting rod small end and check for excessive play.

Measure the connecting rod small end I.D.

Service Limit:

17.03mm replace if over



PISTON/CYLINDER INSTALLATION

First install the expander in the second ring groove.

Then install the top and second rings in their respective ring grooves.

The piston rings should be pressed into the grooves with even force.

After installation, check and make sure that each ring is flush with the piston at several points around the ring.

A ring that will not compress means that the ring groove has carbon deposits in it and should be cleaned.

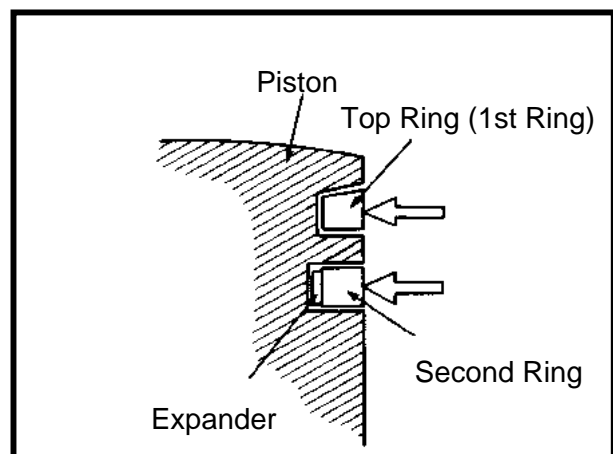

Install a new cylinder gasket on the mating surface between the cylinder and crankcase.



Make sure that the ring end gaps are aligned with the piston ring pins in the ring grooves.

Lubricate the cylinder inside and piston rings with engine oil and install the piston into the cylinder while compressing the piston rings.

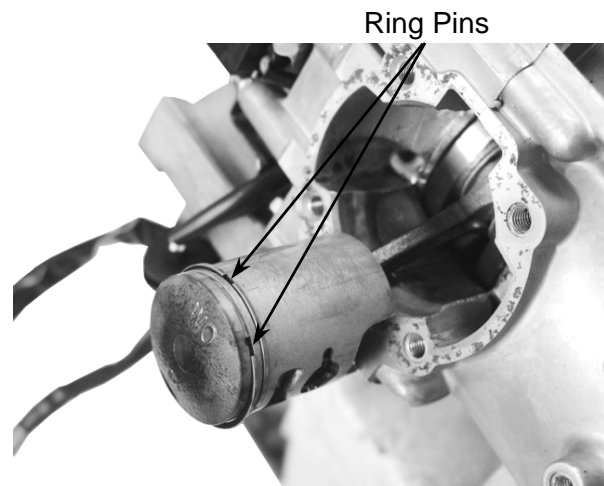

* Be careful not to damage the piston.

Install the cylinder head.

Torque: 1.5~1.7kg-m

Install the exhaust muffler and tighten the exhaust muffler joint lock nuts.

Torque: 1.8~2.2kg-m

Tighten the exhaust muffler lock bolts.

Torque: 3.0~3.6kg-m

Install the frame covers.

Install the met-in box.

The installation sequence is the reverse of removal.

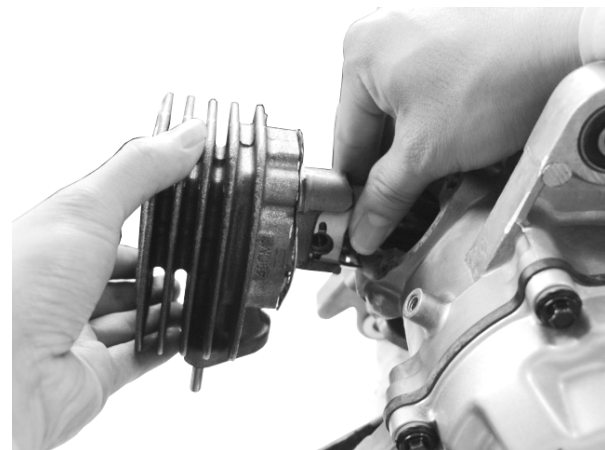

A.C. GENERATOR

SERVICE INFORMATION 7-2
A.C. GENERATOR REMOVAL..... 7-3
A.C. GENERATOR INSTALLATION..... 7-4

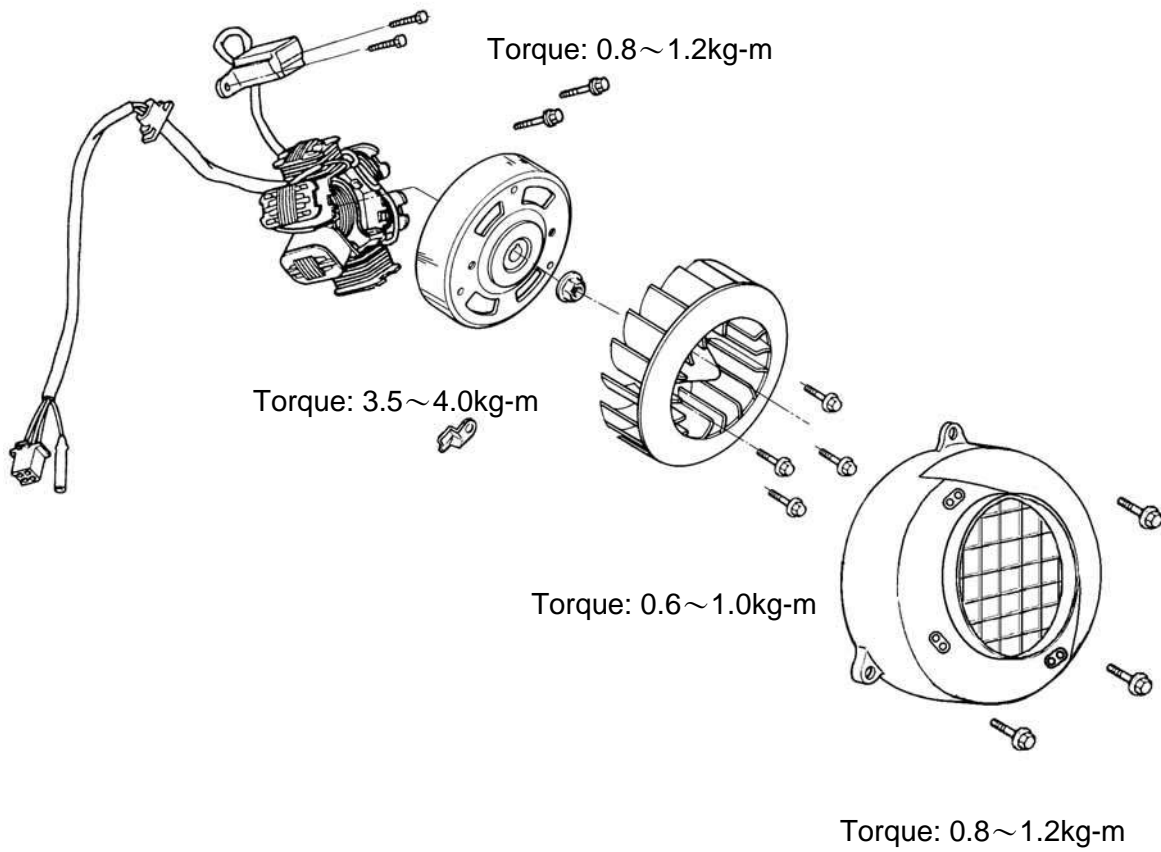

SERVICE INFORMATION

GENERAL INSTRUCTIONS

- All A.C. generator maintenance and inspection can be made with the engine installed.
- Refer to Section 15 for A.C. generator inspection.

TORQUE VALUE

Flywheel nut : 3.5~4.0kg-m

SPECIAL TOOLS

Flywheel puller
Universal holder

A.C. GENERATOR REMOVAL

Remove the three bolts attaching the fan cover to remove the fan cover.

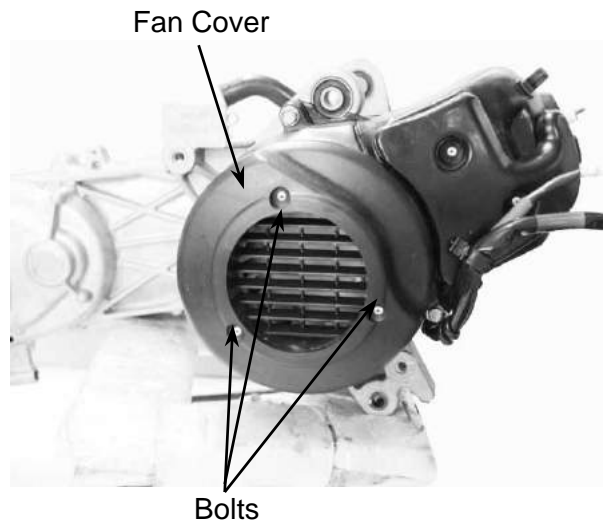

Remove the cooling fan by removing the four bolts.

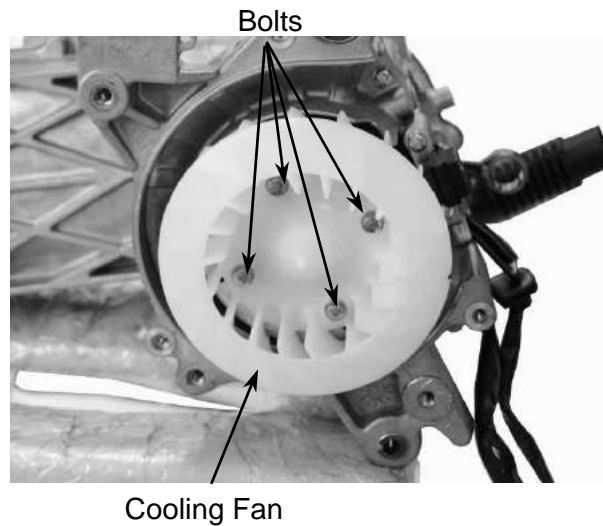

Hold the flywheel with an universal holder and then remove the 10mm flywheel nut.

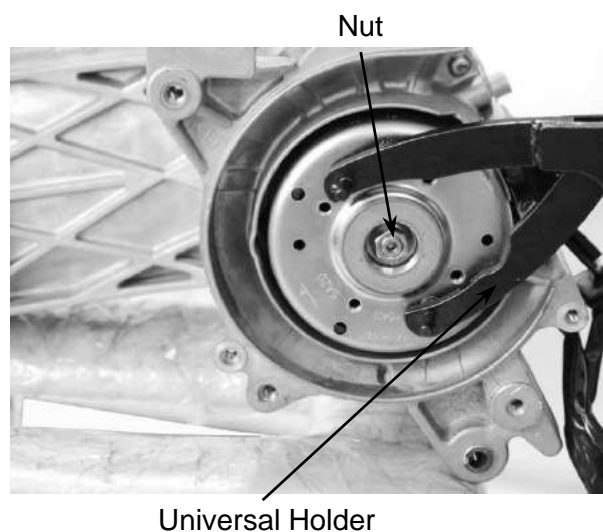

Remove the A.C. generator flywheel using the flywheel puller.

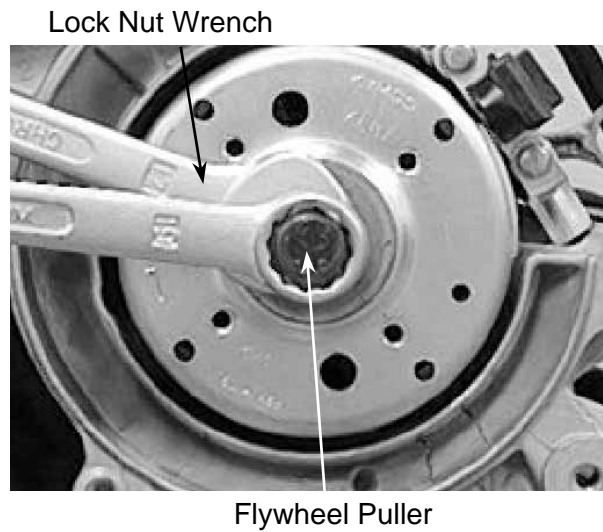

Remove the A.C. generator wire connector.

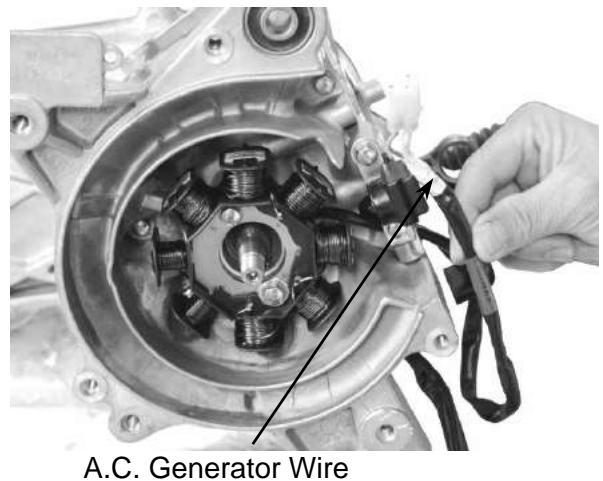

Remove the two pulser coil bolts and pulser coil from the right crankcase.
Remove the pulser coil wire clamp from the right crankcase.
Remove the two bolts attaching the A.C. generator stator.

* Be careful not to damage the disconnected wire.

A.C. GENERATOR INSTALLATION

Install the A.C. generator stator and pulser coil wire clamp onto the right crankcase, and then install the pulser coil.

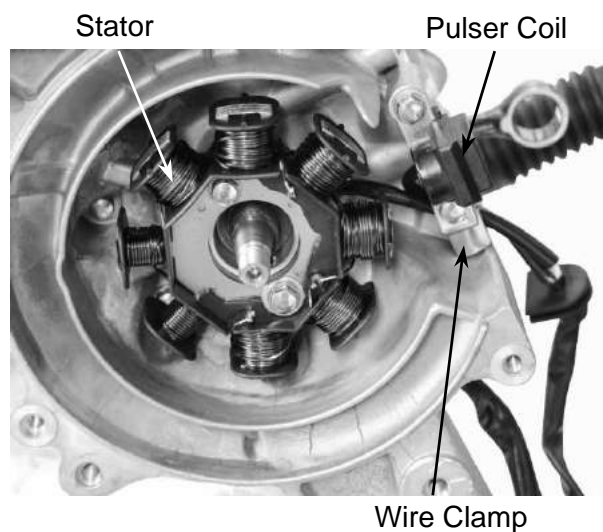

Install the A.C. generator and pulser coil bolts.
Connect the A.C. generator wire connector.

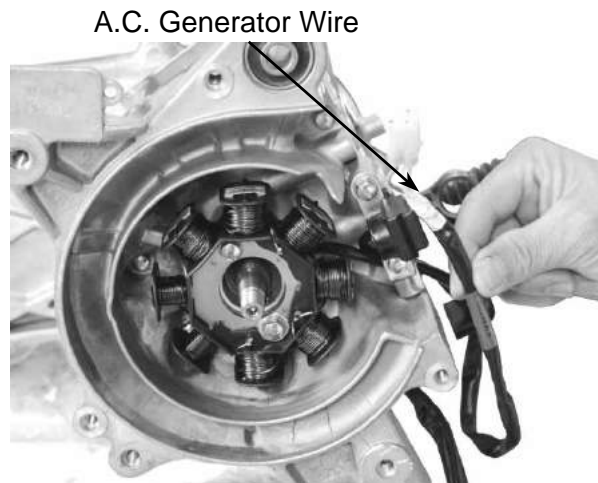

Clean the taper hole in the flywheel off any burrs and dirt.
Install the woodruff key in the crankshaft keyway.



Woodruff Key

Install the flywheel onto the crankshaft with the flywheel groove aligned with the crankshaft woodruff key.
Hold the flywheel with the universal holder and install the 10mm flywheel flange nut.

Torque: 3.5~4.0kg-m

Start the engine and check the ignition timing. (⇒3-8)

Install other removed parts in the reserve order of removal.



Universal Holder

**KICK STARTER/DRIVE PULLEY/
CLUTCH/DRIVEN PULLEY**

SERVICE INFORMATION	8- 2
TROUBLESHOOTING	8- 2
KICK STARTER	8- 3
DRIVE BELT	8- 7
DRIVE PULLEY	8- 9
STARTER ONE-WAY CLUTCH DRIVE GEAR	8- 11
CLUTCH/DRIVEN PULLEY	8- 14

8. KICK STARTER/DRIVE PULLEY/ CLUTCH/DRIVEN PULLEY

SUPER8 50 2T

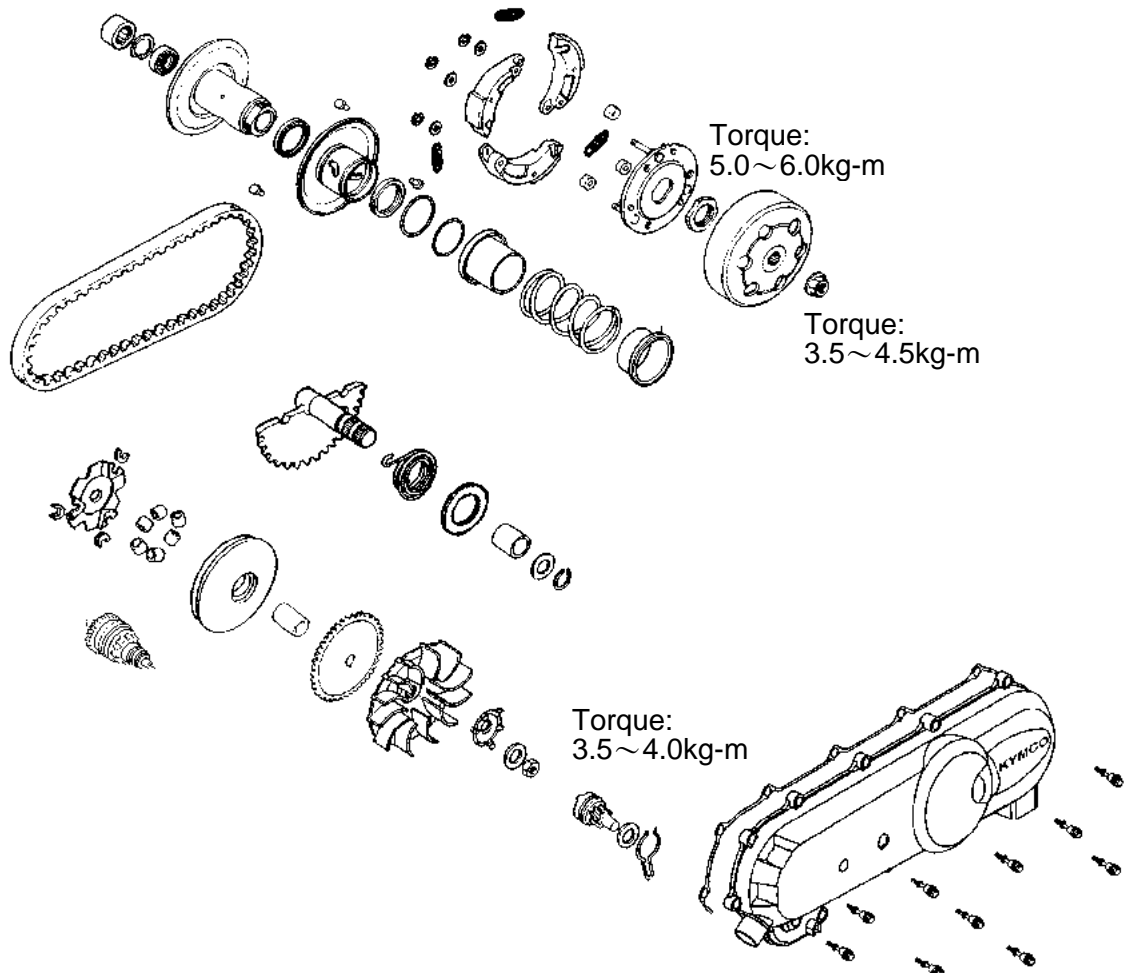

8. KICK STARTER/DRIVE PULLEY/ CLUTCH/DRIVEN PULLEY

SUPER8 50 2T

SERVICE INFORMATION

GENERAL INSTRUCTIONS

- Avoid getting grease and oil on the drive belt and pulley faces.

SPECIFICATIONS	SUPER8 50 2T	
	Standard (mm)	Service Limit (mm)
Drive pulley collar O.D.	20.01~20.025	24.24
Movable drive face I.D.	20.035~20.085	19.97
Weight roller O.D.	13.0	12.4
Clutch outer I.D.	107~107.2	107.5
Driven face spring free length	87.9	82.6
Driven face O.D.	33.965~33.985	33.94
Movable driven face I.D.	34.0~34.25	34.06
Drive belt width	18	17

TORQUE VALUES

Drive face nut	3.5~4.0kg-m
Clutch outer nut	3.5~4.5kg-m
Clutch drive plate nut	5.0~6.0kg-m

SPECIAL TOOLS

Lock nut wrench, 39mm	Universal holder
Clutch spring compressor	Lock nut socket wrench, 32mm
Bearing outer driver 37x40mm	Bearing driver pilot, 17mm
One-way clutch puller	Outer driver, 24x26mm

TROUBLESHOOTING

Engine starts but motorcycle won't move

- Worn drive belt
- Broken ramp plate
- Worn or damaged clutch lining

Engine stalls or motorcycle creeps

- Broken clutch weight spring

Poor performance at high speed or lack of power

- Worn drive belt
- Weak driven face spring
- Worn weight roller
- Faulty driven face

8. KICK STARTER/DRIVE PULLEY/ CLUTCH/DRIVEN PULLEY

SUPER8 50 2T

KICK STARTER

LEFT CRANKCASE COVER REMOVAL

Remove the nine left crankcase cover bolts, left crankcase cover and dowel pins. Inspect the left crankcase cover seal rubber for damage or deterioration.

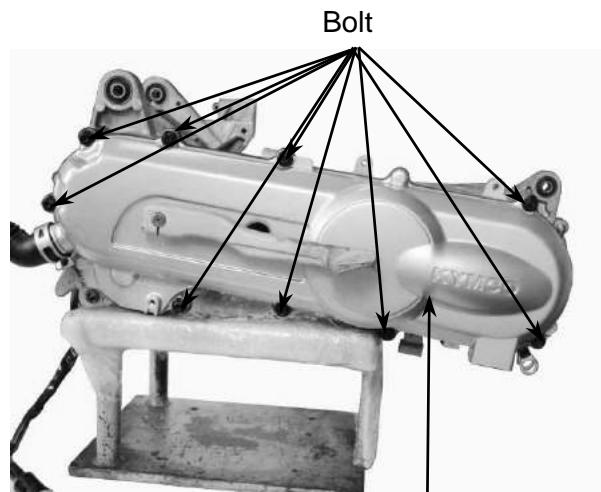

Left Crankcase Cover

KICK STARTER SPINDLE REMOVAL

Remove the kick lever from the kick starter spindle. Remove the circlip and washer from the kick starter spindle.

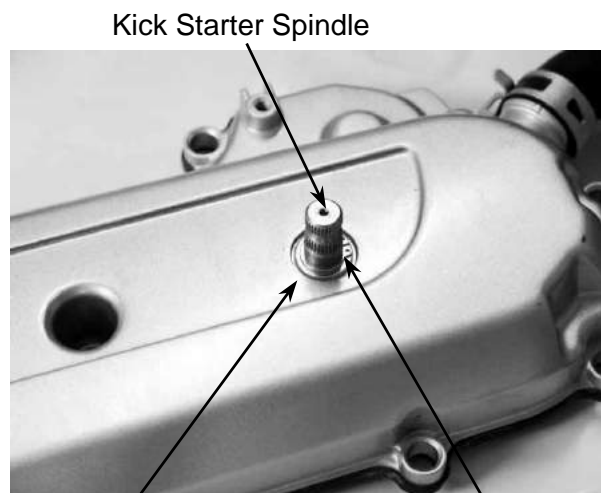

Washer

Circlip

Slightly rotate the kick starter spindle to remove the kick starter driven gear together with the friction spring.

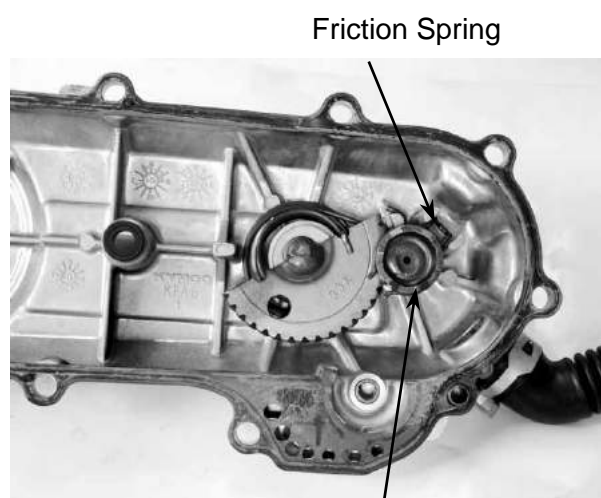

Kick Starter Driven Gear

8. KICK STARTER/DRIVE PULLEY/ CLUTCH/DRIVEN PULLEY

SUPER8 50 2T

Remove the kick starter spindle and return spring from the left crankcase cover.
Remove the kick starter spindle bushing.

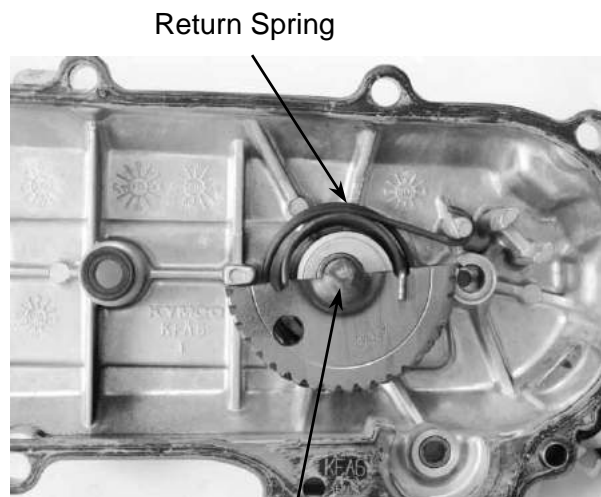

Kick Starter Spindle

KICK STARTER SPINDLE INSPECTION

Inspect the kick starter spindle and gear for wear or damage.
Inspect the return spring for weakness or damage.
Inspect the kick starter spindle bushing for wear or damage.

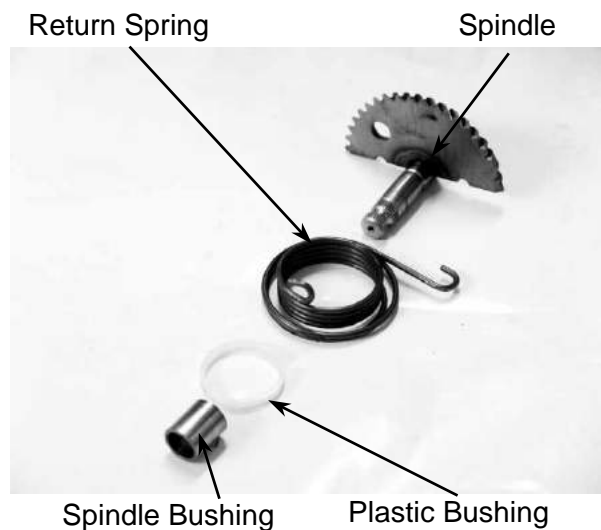

Spindle Bushing

Plastic Bushing

Check the kick starter driven gear for wear or damage.
Check the friction spring for wear or damage.

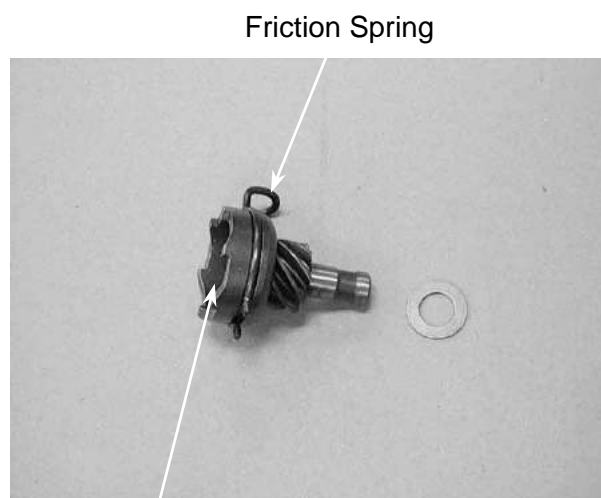

Kick Starter Driven Gear

8. KICK STARTER/DRIVE PULLEY/ CLUTCH/DRIVEN PULLEY

SUPER8 50 2T

Inspect the kick starter spindle and driven gear forcing parts for wear or damage.

Kick Starter Spindle Forcing Part

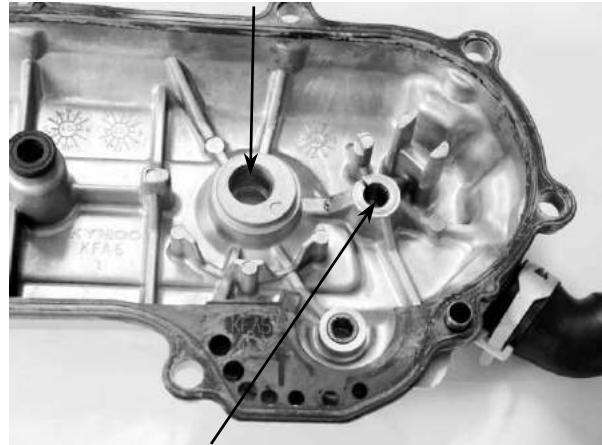

Kick Starter Driven Gear Forcing Part

KICK STARTER INSTALLATION

Install the kick starter spindle bushing and return spring onto the left crankcase cover.

* If the hooks of the return spring can not be installed properly, use a screw driver to press them into their locations respectively.

Friction Spring

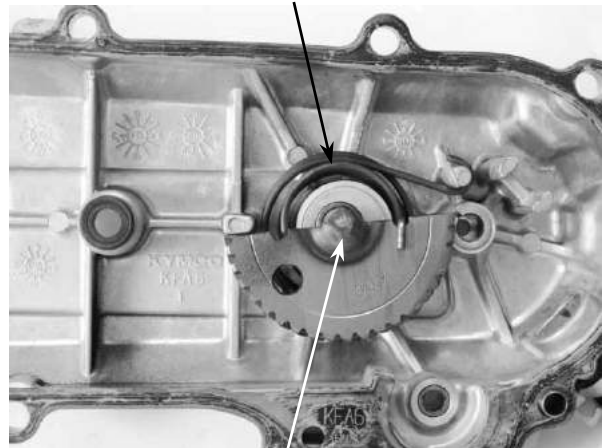

Kick Starter Spindle

Properly install the kick starter driven gear and friction spring as the figure shown.

Friction Spring

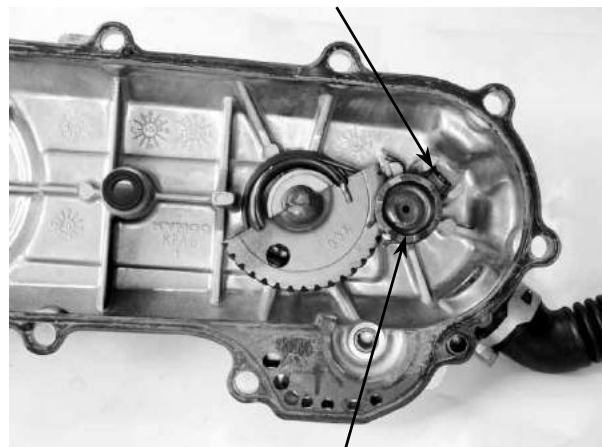

Kick Starter Driven Gear

8. KICK STARTER/DRIVE PULLEY/ CLUTCH/DRIVEN PULLEY

SUPER8 50 2T

First install the washer and then the circlip onto the kick starter spindle. Install the kick lever.

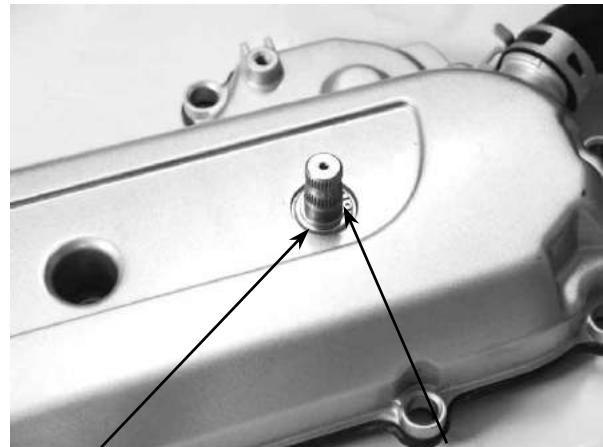

Washer

Circlip

LEFT CRANKCASE COVER INSTALLATION

First install the dowel pins and then the seal rubber.

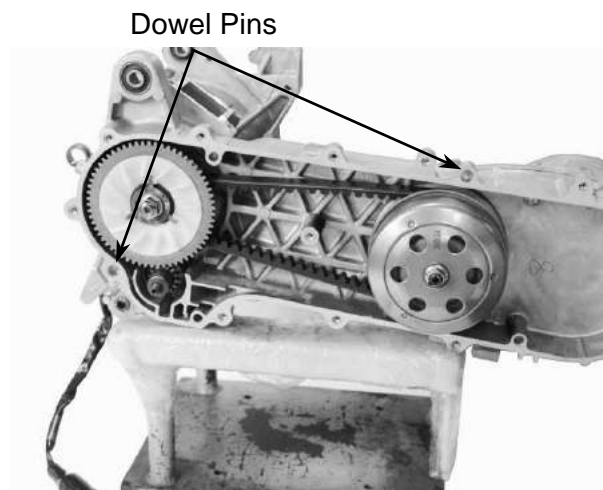

Dowel Pins

Install the left crankcase cover and tighten the ten bolts diagonally. Connect the drive belt cooling air tube and install the circlip.

* For drum brake, note the location of the brake cable clamp and install the rear brake cable in place with the clamp.

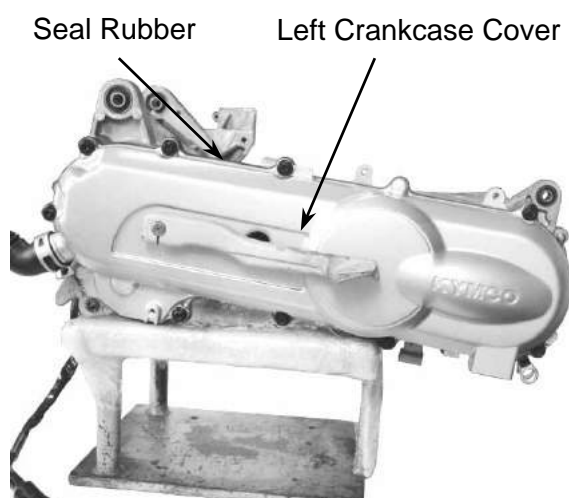

Seal Rubber

Left Crankcase Cover

8. KICK STARTER/DRIVE PULLEY/ CLUTCH/DRIVEN PULLEY

SUPER8 50 2T

DRIVE BELT

Remove the left crankcase cover.

INSPECTION

Check the drive belt for cracks, separation or abnormal or excessive wear.
Measure the drive belt width.

Service Limit:

16.5mm replace if below

* Use specified genuine parts for replacement.

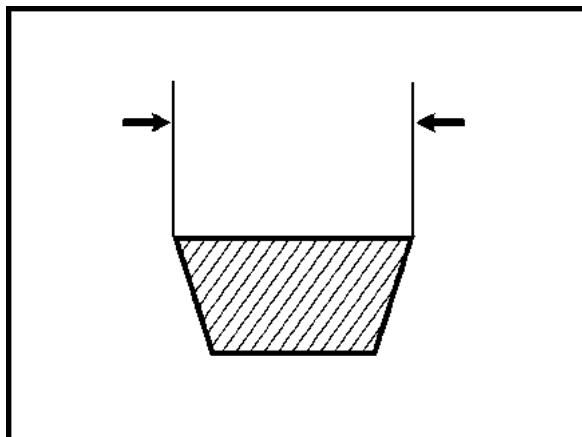

REPLACEMENT

Remove the ten left crankcase cover bolts and left crankcase cover. (⇒8-4)
Hold the clutch outer with the universal holder and remove the 10mm clutch outer nut and clutch outer.

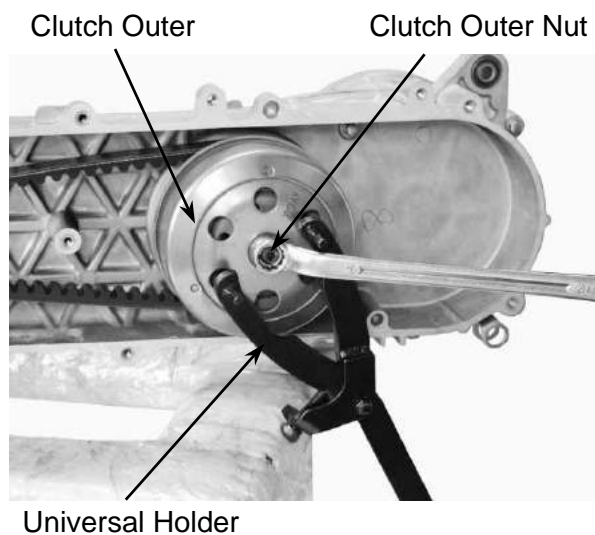

Hold the drive pulley with the holder and remove the 12mm drive face nut.
Remove the starting ratchet.
Remove the drive pulley face.

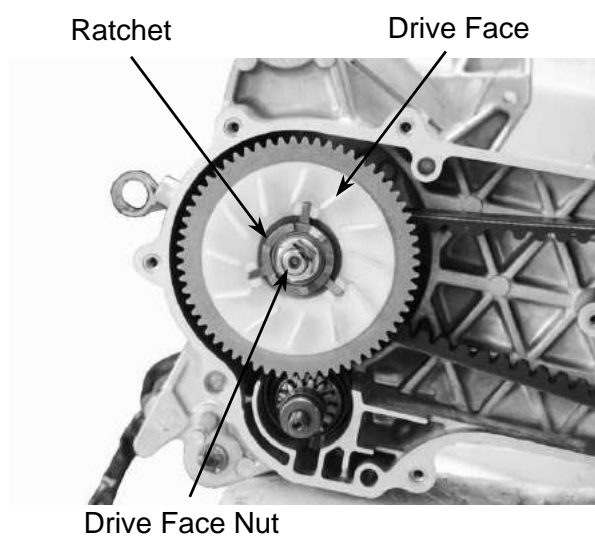

8. KICK STARTER/DRIVE PULLEY/ CLUTCH/DRIVEN PULLEY

SUPER8 50 2T

Remove the drive belt from the clutch/
driven pulley.

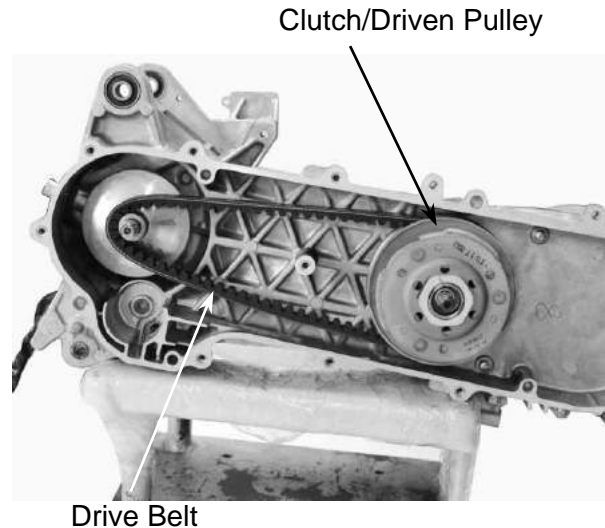

Drive Belt

DRIVE BELT INSTALLATION

Turn the driven pulley clockwise and lift it
up to expand the drive belt groove and then
install a new drive belt.

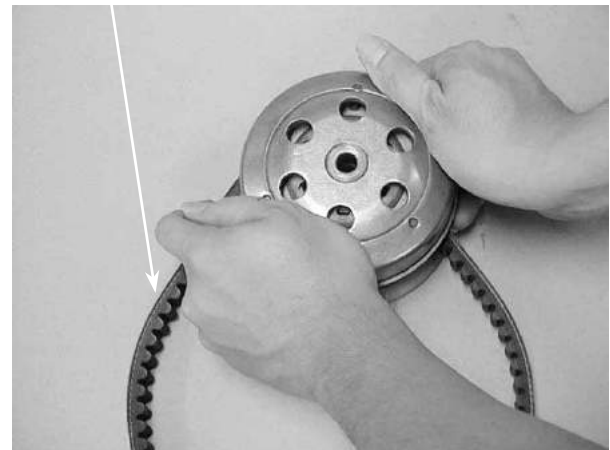

Set the drive belt on the drive pulley.
Install the drive pulley face, starting ratchet
and 12mm washer, then tighten the drive
face nut.

Torque: 3.5~4.0kg-m

* When installing the drive face nut, make
sure that the tooth spaces of the drive
pulley face and starting ratchet align
with the teeth of the crankshaft.

Drive Face Nut Drive Pulley Face Drive Belt

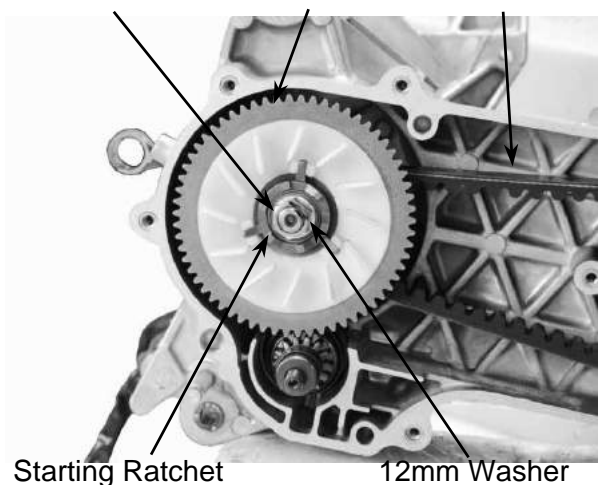

Starting Ratchet

12mm Washer

8. KICK STARTER/DRIVE PULLEY/ CLUTCH/DRIVEN PULLEY

SUPER8 50 2T

DRIVE PULLEY

REMOVAL

Hold the drive pulley with the holder and remove the 12mm drive face nut. Remove the starting ratchet, 12mm washer and drive pulley face.

Drive Pulley Face

Starting Ratchet

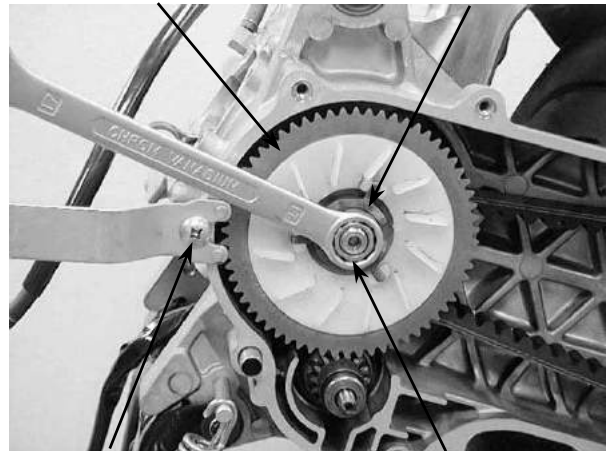

Face Holder

12mm Drive Face Nut

MOVABLE DRIVE FACE DISASSEMBLY

Remove the movable drive face and drive pulley collar from the crankshaft.

Drive Pulley Collar

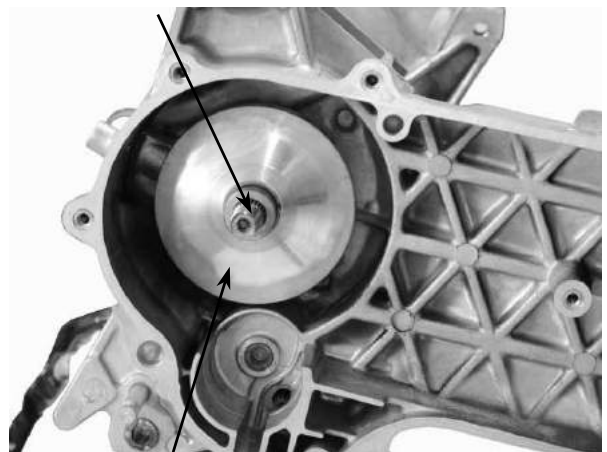

Movable Drive Face

Remove the ramp plate.

Ramp Plate



8. KICK STARTER/DRIVE PULLEY/ CLUTCH/DRIVEN PULLEY

SUPER8 50 2T

MOVABLE DRIVE FACE INSPECTION

Remove the weight rollers.

Check each weight roller for wear or damage.

Measure each roller O.D.

Service Limit:

12.4mm replace if below

Weight Roller

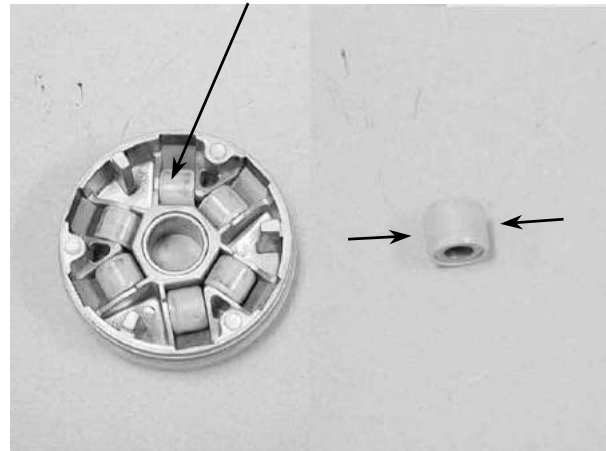

Measure the movable drive face bushing assembly I.D.

Service Limit:

20.3mm replace if over

Check the drive pulley collar for wear or damage.

Measure the O.D. of the drive pulley collar sliding surface.

Service Limit:

19.9mm replace if below

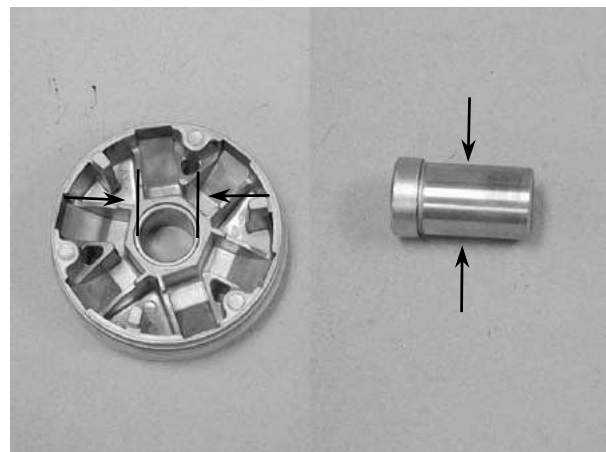

DRIVE PULLEY INSTALLATION

Install the drive pulley collar and movable drive face onto the crankshaft.

Movable Drive Face

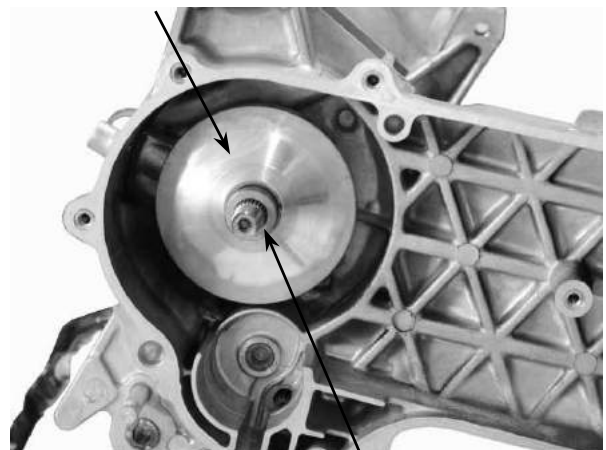

Drive Pulley Collar

8. KICK STARTER/DRIVE PULLEY/ CLUTCH/DRIVEN PULLEY

SUPER8 50 2T

Install the drive belt on the crankshaft.
Install the drive face, starting ratchet and
washer, then tighten the 12mm drive face
nut.

Torque: 3.5~4.0kg-m

* Keep grease or oil off the drive belt and
drive pulley faces.

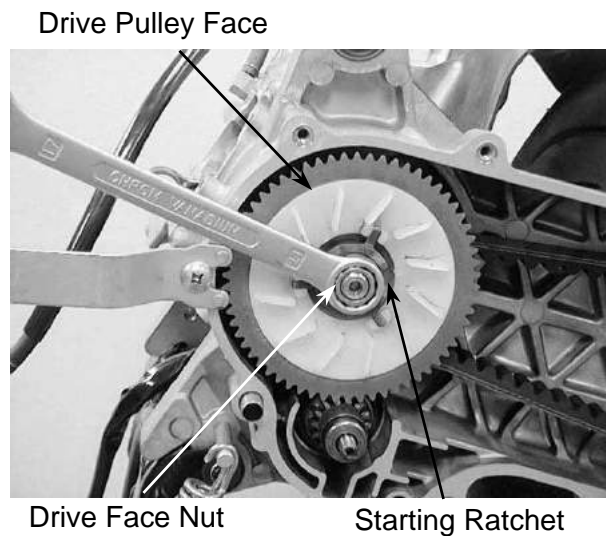

STARTER PINION REMOVAL

Remove the left crankcase cover. (⇒8-4)
Remove the drive pulley. (⇒8-8)
Remove the starter pinion.

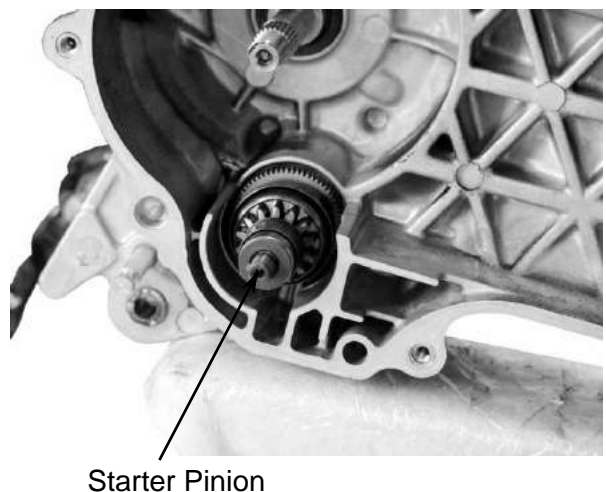

INSPECTION

Inspect the starter pinion seat for wear.
Inspect the starter pinion for smooth
operation.
Inspect the starter pinion shaft forcing parts
for wear and damage.

INSTALLATION

Apply a small amount of grease to the
starter pinion teeth.
Install the starter pinion in the reverse order
of removal.

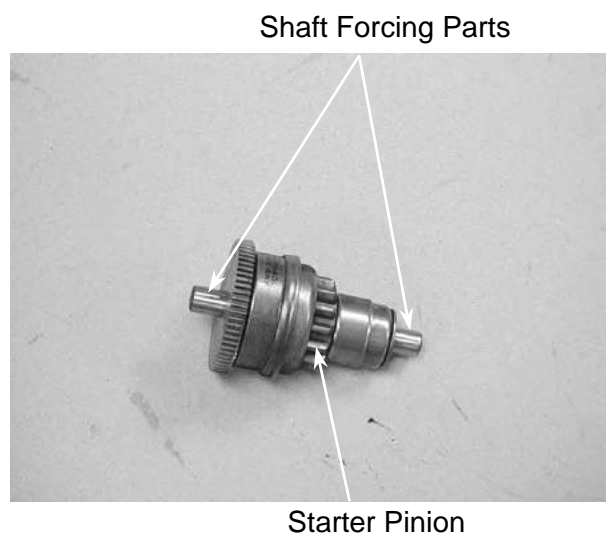

8. KICK STARTER/DRIVE PULLEY/ CLUTCH/DRIVEN PULLEY

SUPER8 50 2T

CLUTCH/DRIVEN PULLEY

CLUTCH/DRIVEN PULLEY REMOVAL

Remove the drive pulley. (⇒8-8)
Hold the clutch outer with the universal holder and remove the 10mm clutch outer nut.
Remove the clutch outer.

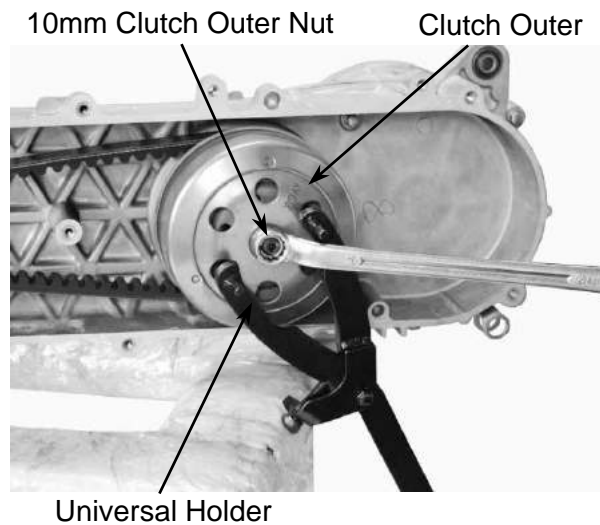

Remove the clutch/driven pulley.
Remove the drive belt from the clutch/driven pulley.

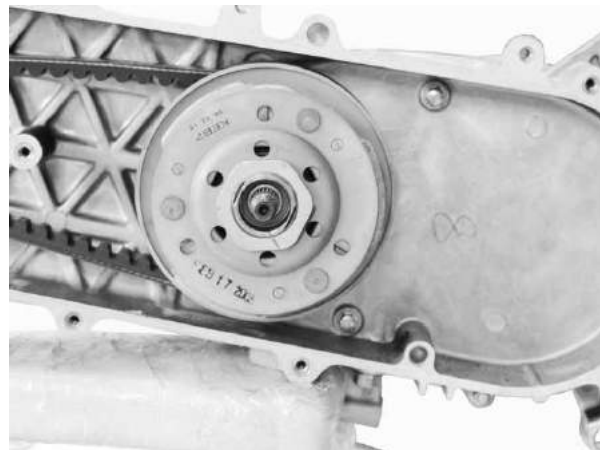

CLUTCH/DRIVEN PULLEY DIS- ASSEMBLY

Compress the clutch/driven pulley spring with the clutch spring compressor and remove the 28mm drive plate nut.
Remove the driven face spring.

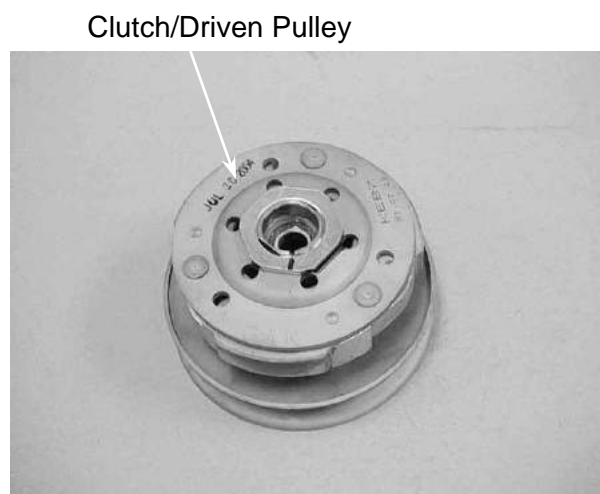

8. KICK STARTER/DRIVE PULLEY/ CLUTCH/DRIVEN PULLEY

SUPER8 50 2T

Remove the seal collar.



Seal Collar

Pull out the guide roller pins from the driven pulley and then remove the O-rings and oil seal from the driven pulley.

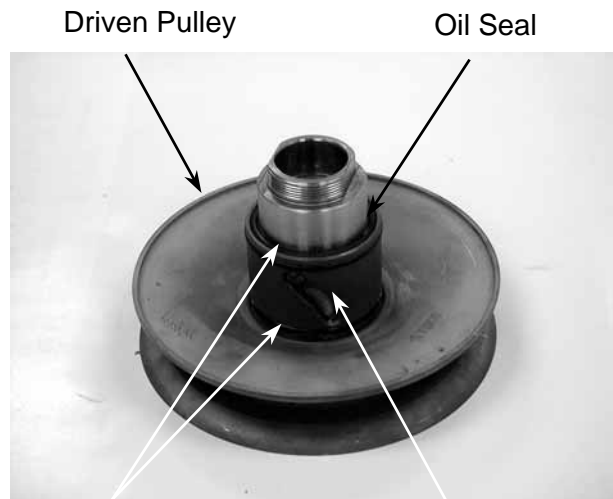

O-rings

Guide Roller Pin

CLUTCH/DRIVEN PULLEY INSPECTION

Inspect the clutch outer for wear or damage.

Measure the clutch outer I.D.

Service Limit:

107.5mm replace if below

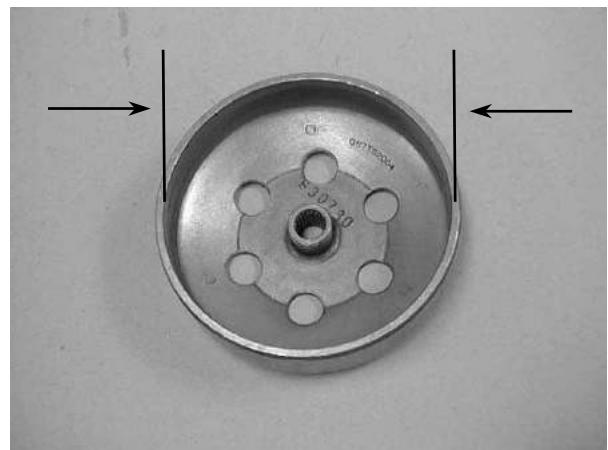

8. KICK STARTER/DRIVE PULLEY/ CLUTCH/DRIVEN PULLEY

SUPER8 50 2T

Check the clutch shoes for wear or damage.

Measure the clutch lining thickness.

Service Limit: 2.0mm replace if below

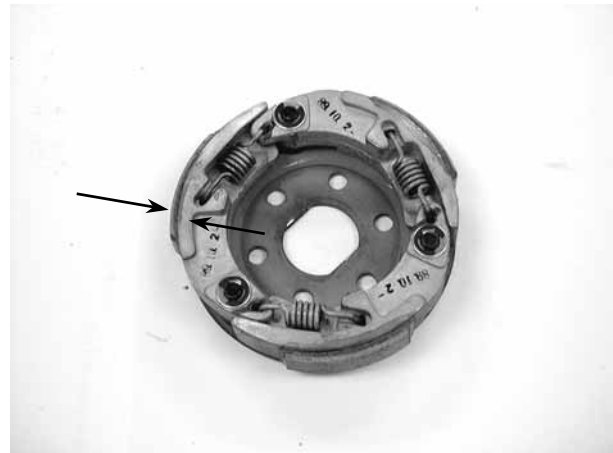

Measure the driven face spring free length.

Service Limit:

82.6mm replace if below

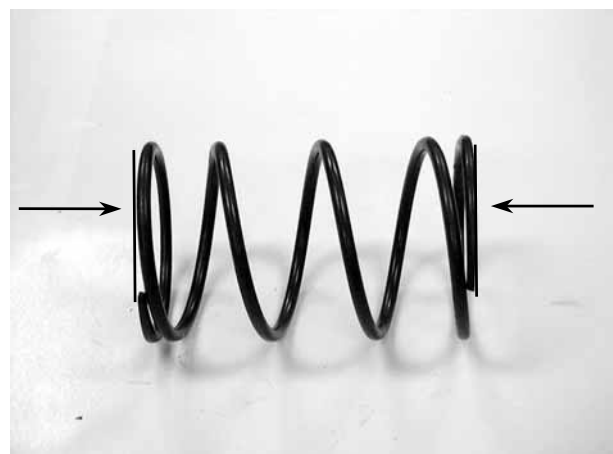

Check the driven face assembly for wear or damage.

Measure the driven face O.D.

Service Limit: 33.94mm replace if below

Check the movable driven face for wear or damage.

Measure the movable driven face I.D.

Service Limit: 34.06mm replace if below

Check the guide roller pins for stepped wear.



8. KICK STARTER/DRIVE PULLEY/ CLUTCH/DRIVEN PULLEY

SUPER8 50 2T

DRIVEN PULLEY FACE BEARING REPLACEMENT

Check the needle bearings in the driven face and replace them if they have excessive play, damage or abnormal noise. Drive the inner bearing out of the driven pulley face.

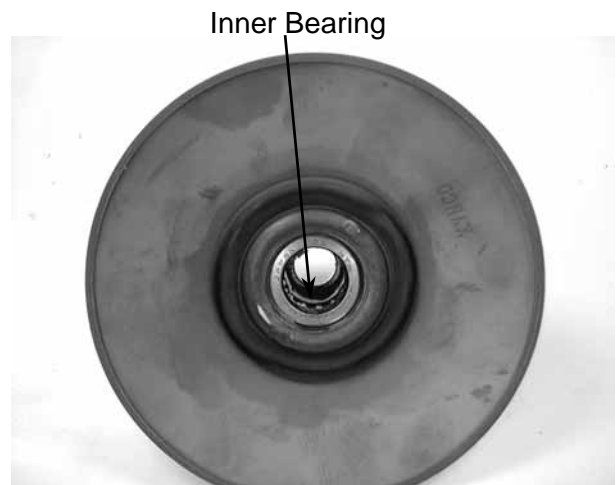

Remove the snap ring and drive the outer bearing out of the driven face.

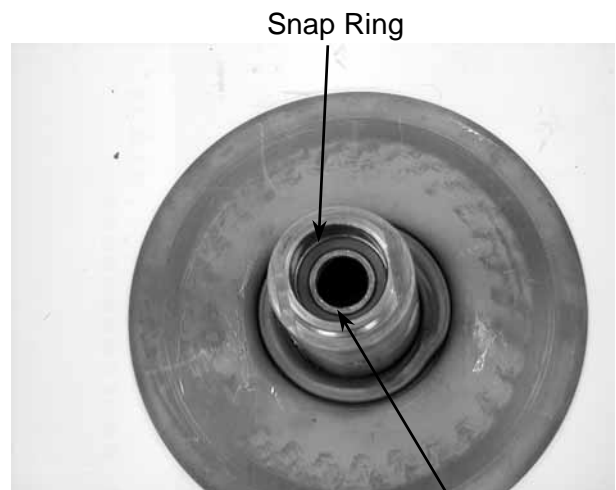

Outer Bearing

Drive a new outer bearing into the driven face with the sealed end facing up. Seat the snap ring in its groove.

* Pack all bearing cavities with 5.0~5.6g grease.
Specified grease: 230°C Heat-resistant grease

Bearing Outer Driver, 37x40mm



8. KICK STARTER/DRIVE PULLEY/ CLUTCH/DRIVEN PULLEY

SUPER8 50 2T

Drive in a new needle bearing into the driven face with the mark facing up.

Bearing Driver Pilot



Outer Driver, 24x26mm

CLUTCH/DRIVEN PULLEY ASSEMBLY

First install the movable driven face onto the driven face. Then, install the guide roller pins, O-rings and a new oil seal.

Driven Pulley

Oil Seal

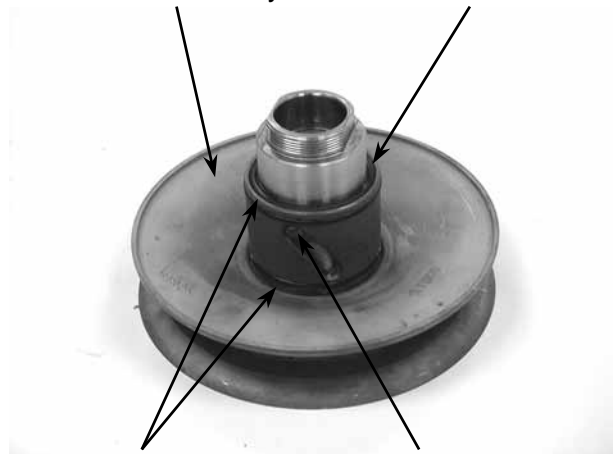

O-rings

Guide Roller Pin

Install the seal collar.



Seal Collar

8. KICK STARTER/DRIVE PULLEY/ CLUTCH/DRIVEN PULLEY

SUPER8 50 2T

Set the driven pulley, driven face spring and clutch assembly onto the clutch spring compressor. Compress the tool and install the 28mm drive plate nut.

Tighten the 28mm nut to the specified torque.

Torque: 5.0~6.0kg-m

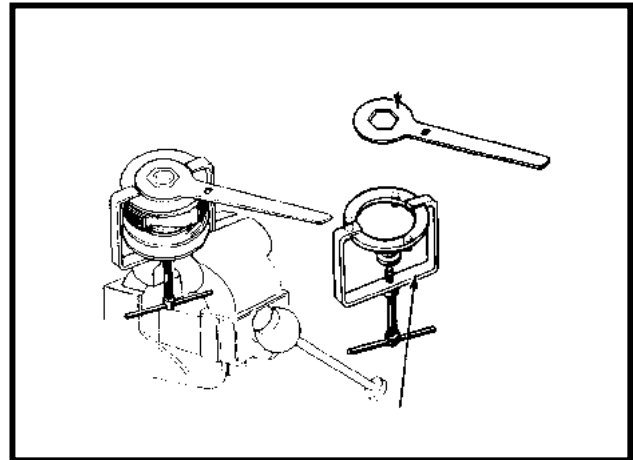

CLUTCH/DRIVEN PULLEY INSTALLATION

Install the drive belt on the clutch/driven pulley and then install the clutch/driven pulley onto the drive shaft.

Clutch/Driven Pulley

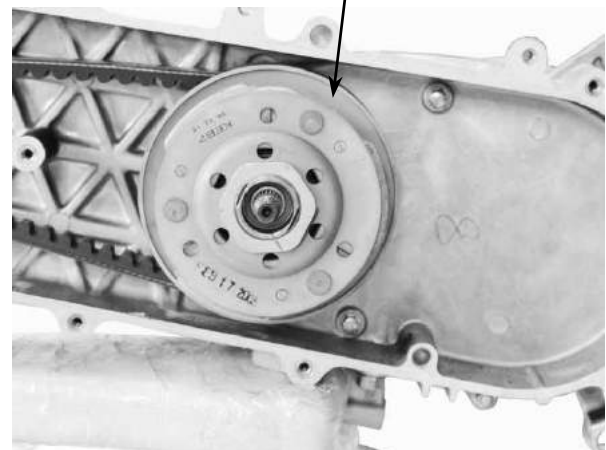

Install the clutch outer.
Hold the clutch outer with the universal holder.
Install and tighten the 10mm clutch outer nut.

Torque: 3.5~4.5kg-m

Install the left crankcase cover. (⇒8-7)

Universal Holder

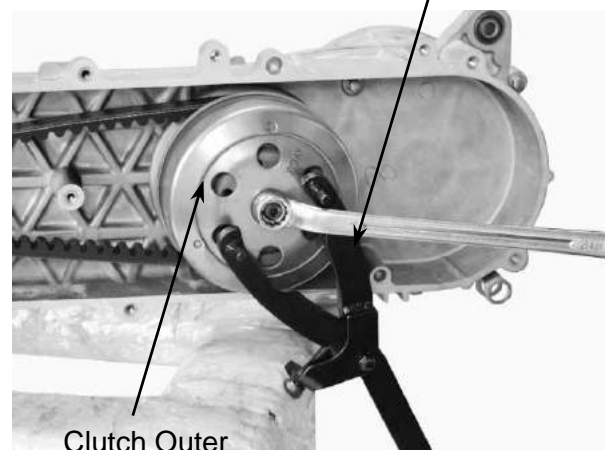

Clutch Outer

FINAL REDUCTION

SERVICE INFORMATION 9-2

TROUBLESHOOTING 9-2

FINAL REDUCTION DISASSEMBLY 9-3

FINAL REDUCTION INSPECTION 9-3

FINAL REDUCTION ASSEMBLY 9-6

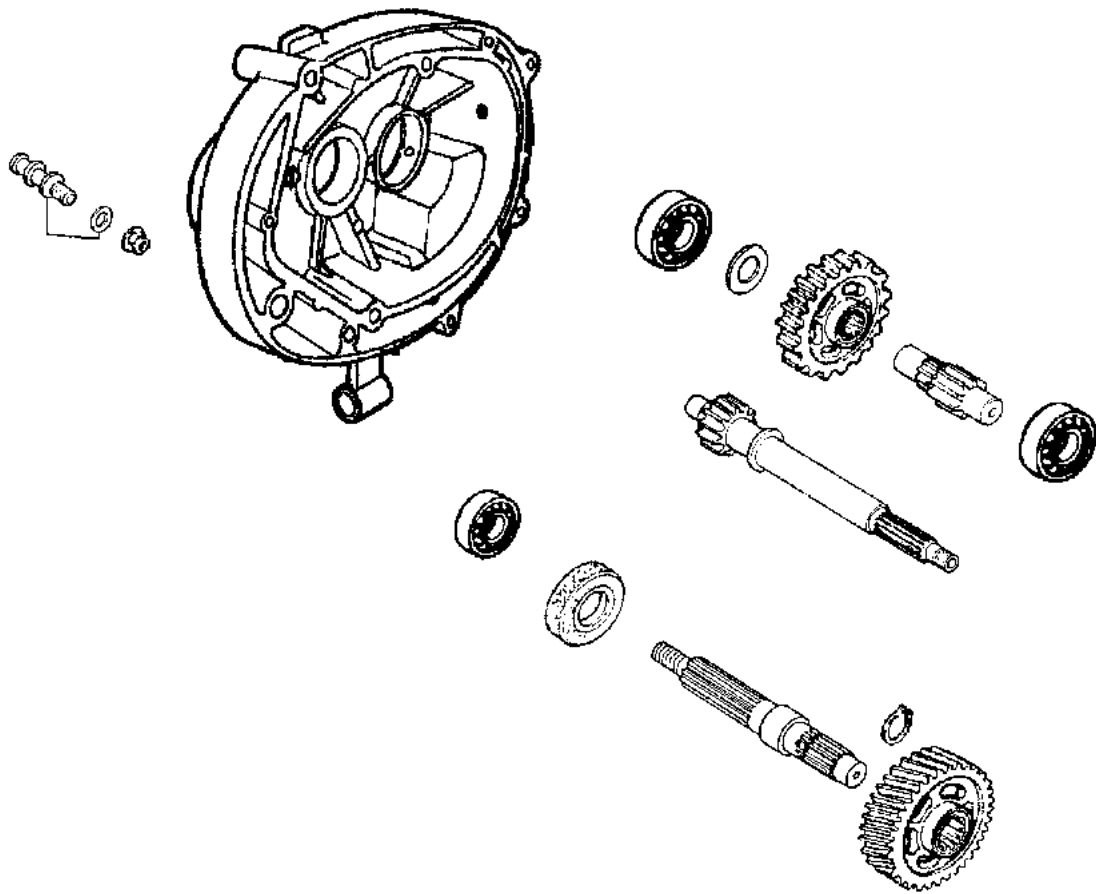

SERVICE INFORMATION

Specified Oil: SAE90#

At disassembly: 0.12 liter

At change: 0.1 liter

SPECIAL TOOLS

Bearing remover set, 12mm

Bearing remover set, 15mm

Crankcase assembly collar

Crankcase assembly shaft

Bearing outer driver, 37x40mm

Bearing outer driver, 32x35mm

Bearing driver pilot, 17mm

Bearing driver pilot, 15mm

Bearing driver pilot, 12mm

Bearing outer driver handle A

TROUBLESHOOTING

Engine starts but motorcycle won't move

- Damaged transmission
- Seized or burnt transmission

Abnormal noise

- Worn, seized or chipped gears
- Worn bearing

Oil leaks

- Oil level too high
- Worn or damaged oil seal

FINAL REDUCTION DISASSEMBLY

- Remove the rear wheel. (⇒14-3)
- Remove the left crankcase cover. (⇒8-4)
- Remove the clutch/driven pulley. (⇒8-15)
- Drain the transmission gear oil into a clean container.
- Remove the transmission case cover attaching bolts.
- Remove the transmission case cover.
- Remove the gasket and dowel pins.

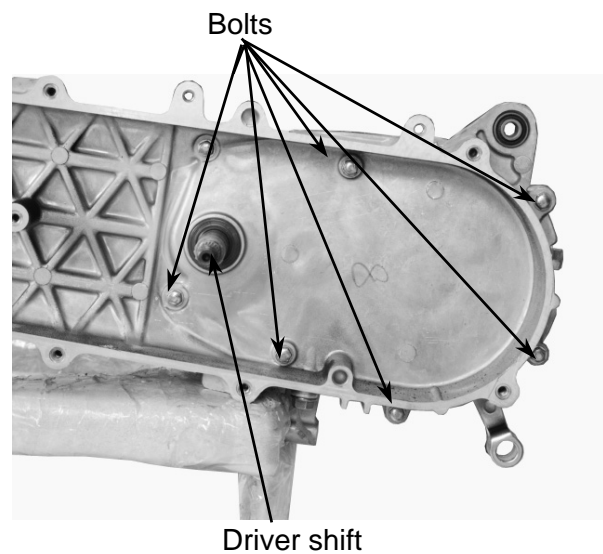

Remove the final gear and countershaft.

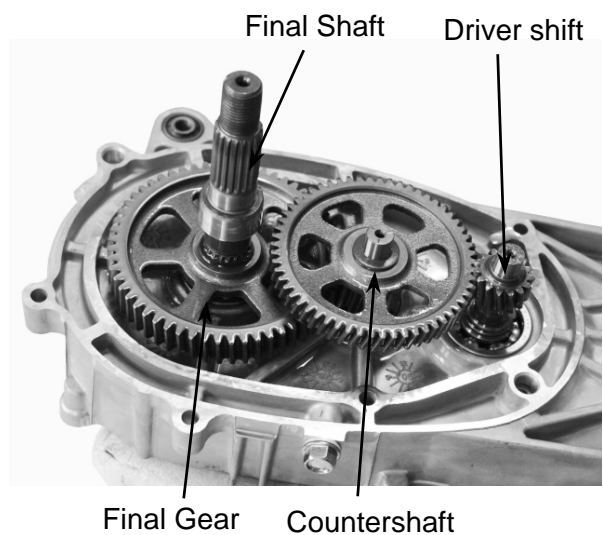

FINAL REDUCTION INSPECTION

Inspect the countershaft and gear for wear or damage.

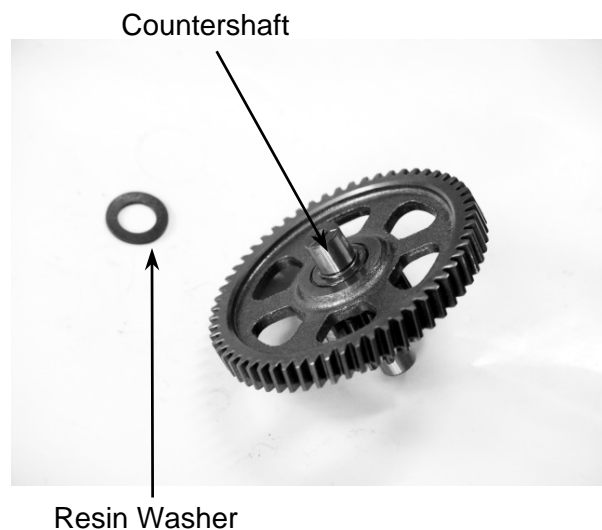

Inspect the final gear and final shaft for wear, damage or seizure.



Check the left crankcase bearings for excessive play and inspect the oil seal for wear or damage.

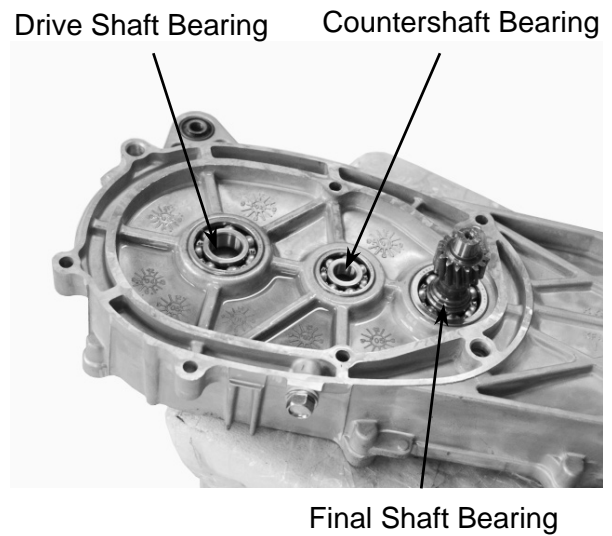

Inspect the drive shaft and gear for wear or damage.
Check the transmission case cover bearings for excessive play and inspect the final shaft bearing oil seal for wear or damage.

* Do not remove the transmission case cover except for necessary part replacement. When replacing the drive shaft, also replace the bearing and oil seal.

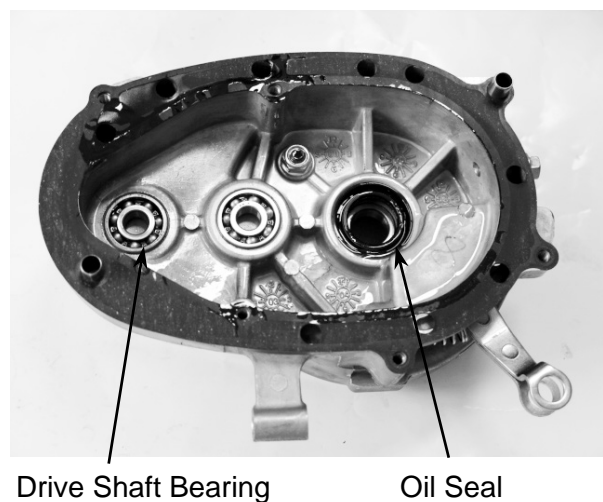

BEARING REPLACEMENT (Transmission Case Cover)

Remove the transmission case cover bearings using the bearing remover.
Remove the final shaft oil seal.

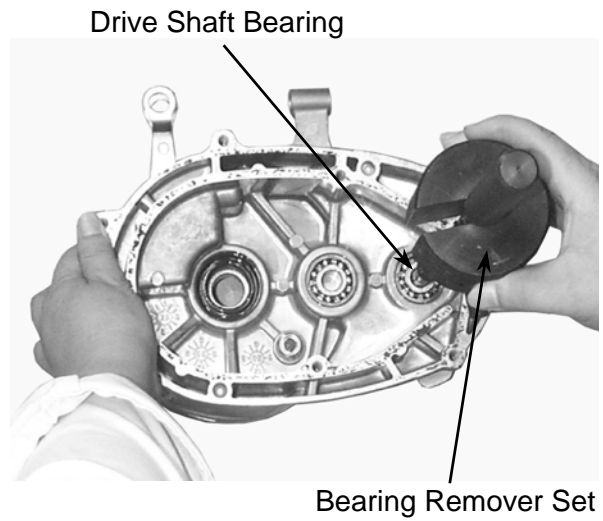

Drive new bearings into the transmission case cover.

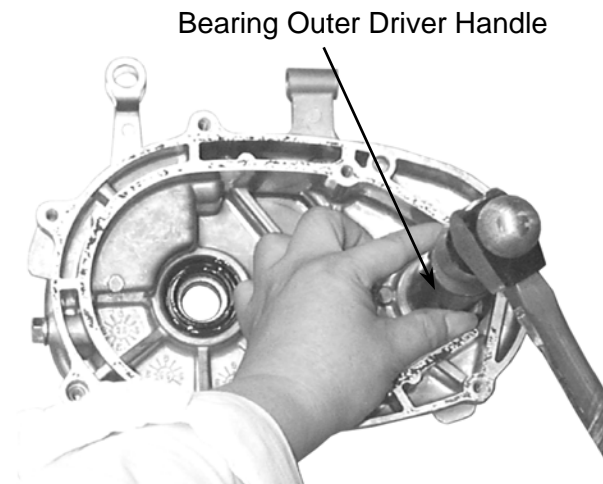

BEARING REPLACEMENT (Left Crankcase Cover)

Remove the drive shaft.
Remove the drive shaft oil seal.
Remove the left crankcase bearings using the bearing remover.

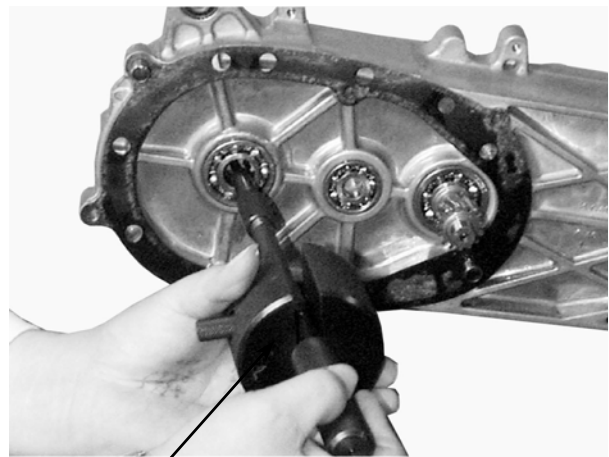

9. FINAL REDUCTION

SUPER8 50 2T

Drive new bearings into the left crankcase.
Install a new drive shaft oil seal.

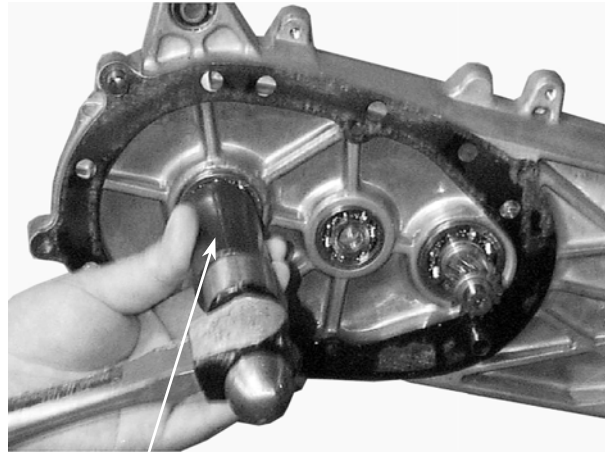

Bearing Outer Driver

FINAL REDUCTION ASSEMBLY

Install the drive shaft into the left crankcase.



Install the final gear and final shaft into the left crankcase.



Final Shaft

Install the countershaft and gear into the left crankcase.
Install the resin washer onto the countershaft.
Install the dowel pins and a new gasket.

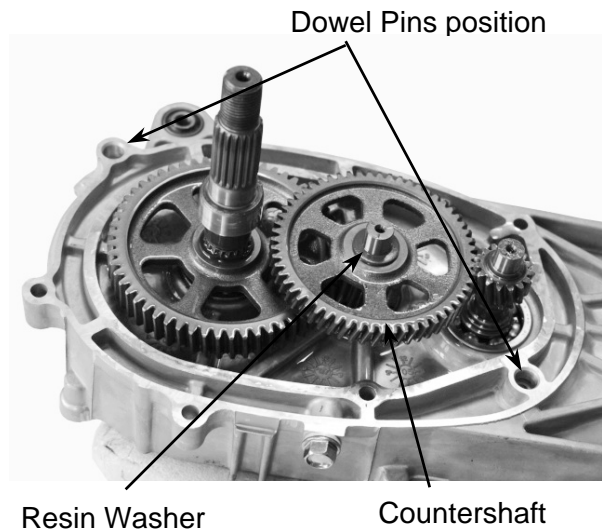

Install the transmission case cover.

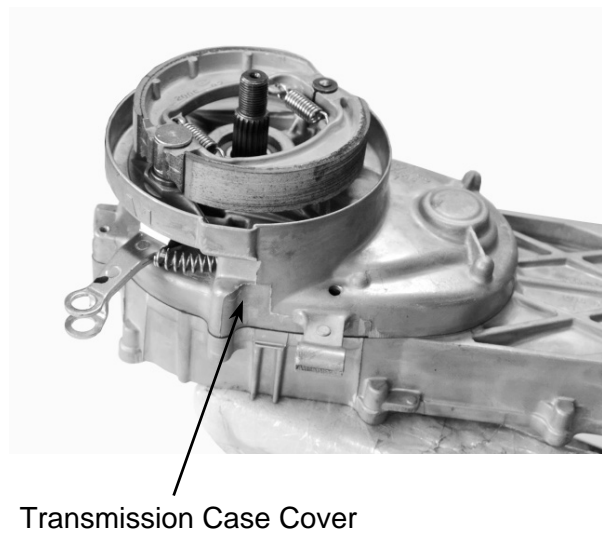

Install and tighten the transmission case cover bolts.
Install the clutch/driven pulley. (⇒8-20)
Install other removed parts in the reverse order of removal.

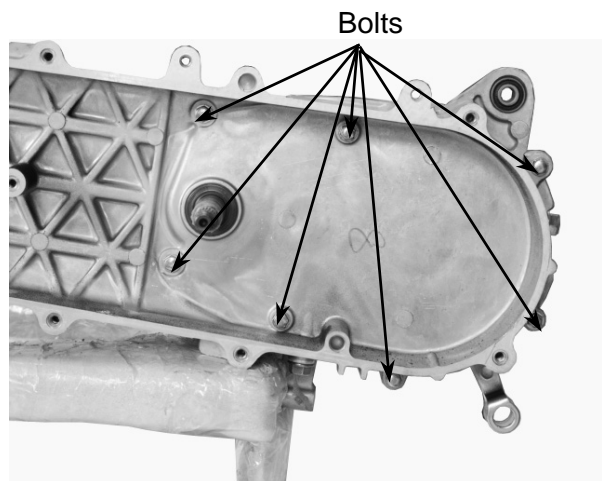

After installation, fill the transmission case with the specified oil.

*

- Place the motorcycle on its main stand on level ground.
- Check the sealing washer for wear or damage.

Specified Gear Oil: SAE90#

Oil Capacity: at disassembly: 0.12 liter

at change: 0.09 liter

Install and tighten the oil check bolt.

Torque: 1.0~1.5kg-m

Start the engine and check for oil leaks.

Check the oil level from the oil check bolt hole and add the specified oil to the proper level if the oil level is low.

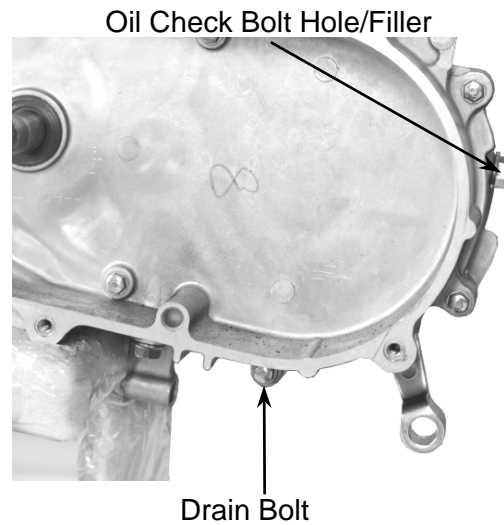

CRANKCASE/CRANKSHAFT

SERVICE INFORMATION 10-2
TROUBLESHOOTING..... 10-2
CRANKCASE SEPARATION 10-3
CRANKSHAFT REMOVAL..... 10-3
CRANKSHAFT INSPECTION..... 10-4
CRANKSHAFT INSTALLATION..... 10-5
CRANKCASE ASSEMBLY 10-7

Torque: 0.8~1.2kg-m

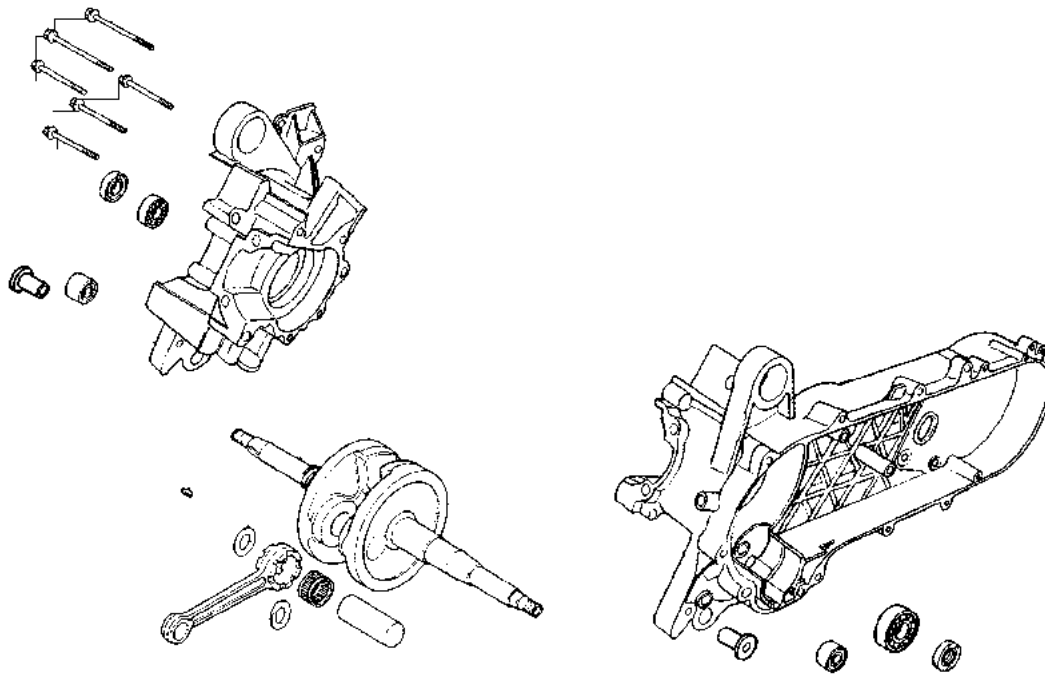

SERVICE INFORMATION

GENERAL INSTRUCTIONS

- This section covers crankcase separation to service the crankshaft.
- The following parts must be removed before separating the crankcase.

Engine (⇒Section 5)	Driven pulley (⇒Section 9)
Carburetor (⇒Section 11)	A.C. generator (⇒Section 7)
Oil pump (⇒Section 4)	Cylinder head/cylinder (⇒Section 6)
Reed valve (⇒Section 11)	
- When the left crankcase must be replaced, remove the following part in addition to the above.
 - Final reduction removal
- Special tools must be used for crankshaft and crankcase assembly. When separating the crankcase, the bearing will remain in the crankcase and it should be removed. When, assembling, drive a new bearing into the crankcase and install a new oil seal.

SPECIFICATIONS

Item	SUPER8 50 2T	
	Standard (mm)	Service Limit (mm)
Connecting rod big end side clearance	—	0.60
Connecting rod big end radial clearance	—	0.04
Crankshaft runout A/B	—	0.15/0.10

SPECIAL TOOLS

Crankcase puller	Bearing outer driver handle A
Universal bearing puller	Bearing outer driver, 42x47mm
Crankcase assembly collar	Bearing driver pilot, 20mm
Crankcase assembly tool	Bearing outer driver, 37x40mm
	Bearing driver pilot, 17mm

TROUBLESHOOTING

Abnormal engine noise

- Excessive crank journal bearing play
- Excessive crankpin bearing play
- Excessive transmission bearing play

CRANKCASE SEPARATION

Remove the crankcase attaching bolts.



Bolts

Attach the crankcase puller on the right crankcase and remove the right crankcase from the left crankcase.

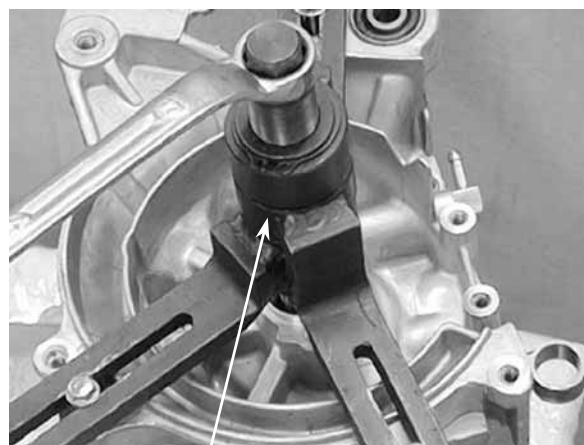

Crankcase Puller

CRANKSHAFT REMOVAL

Attach the crankcase puller on the left crankcase and remove the crankshaft from the left crankcase.

* When removing the crankshaft, do it slowly and gently.

Crankcase Puller

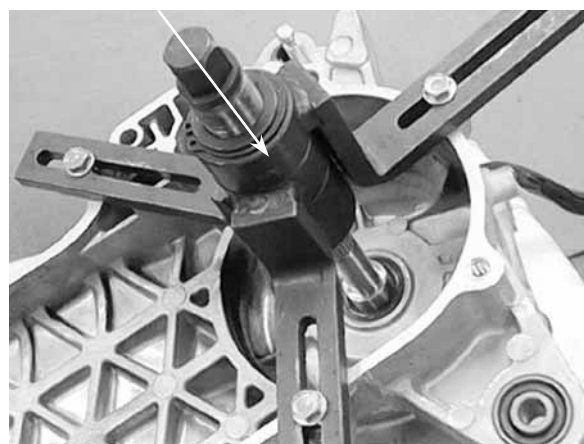

Remove the remaining bearing on the crankshaft side using the universal bearing puller.

* When separating the crankcase, the oil seals must be removed. Replace the oil seals with new ones.

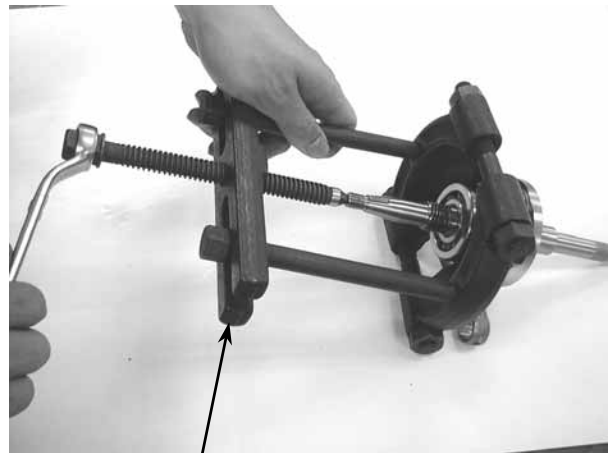

Universal Bearing Puller

CRANKSHAFT INSPECTION

Measure the connecting rod big end side clearance.

Service Limit: 0.6mm replace if over

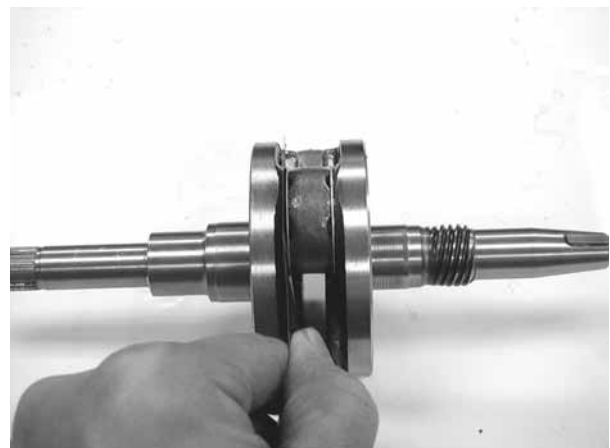

Measure the connecting rod big end radial clearance at two points in the X and Y directions.

Service Limit: 0.04mm replace if over

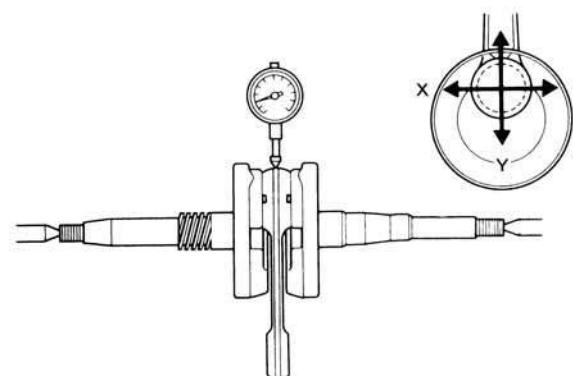

Measure the crankshaft runout.

Service Limit	
A	B
0.150mm replace if over	0.100mm replace if over

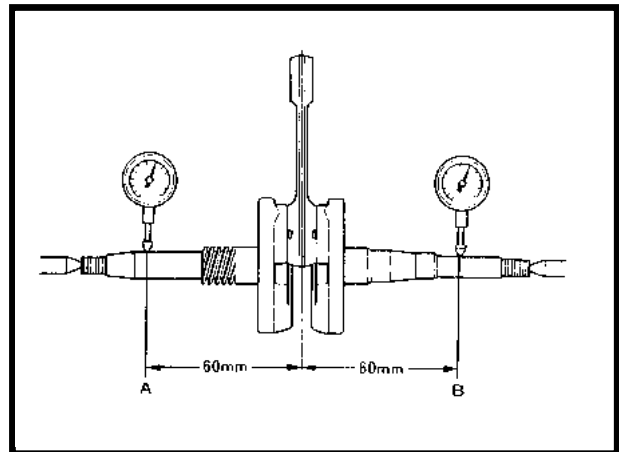

Check the crankshaft bearings for excessive play. The bearings must be replaced if they are noisy or have excessive play.

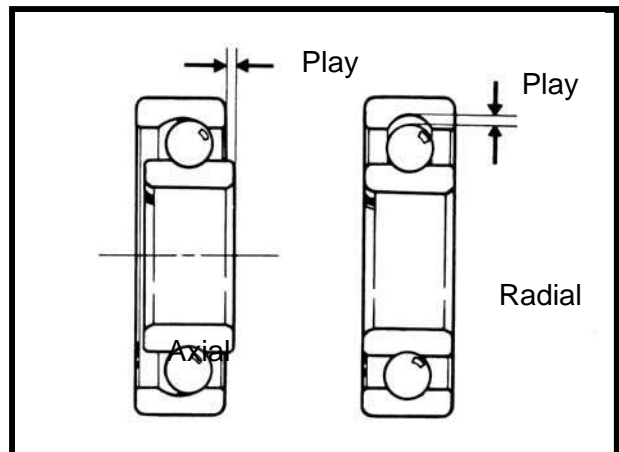

CRANKSHAFT INSTALLATION

Wash the crankshaft in cleaning solvent and then check for cracks or other faults.

- * _____
- After check, apply clean engine oil to all moving and sliding parts.
 - Remove all gasket material from the crankcase mating surfaces. Dress any roughness or irregularities with an oil stone.

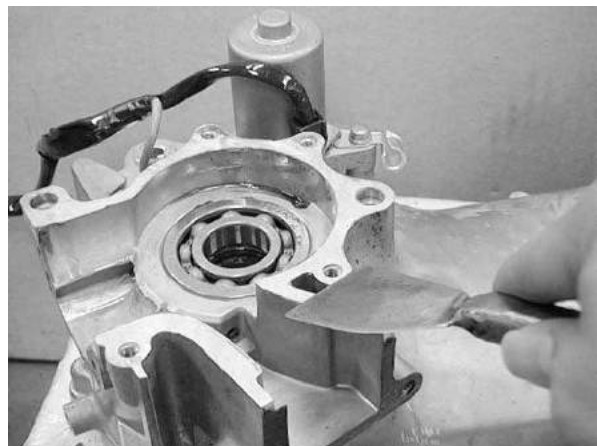

Drive a new crankshaft bearing into the right crankcase.

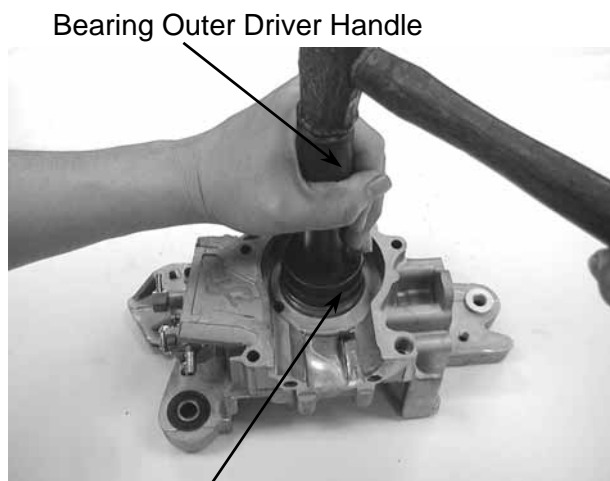

Bearing Outer Driver, 37x40mm
Bearing Driver Pilot, 17mm

Drive a new crankshaft bearing into the left crankcase.

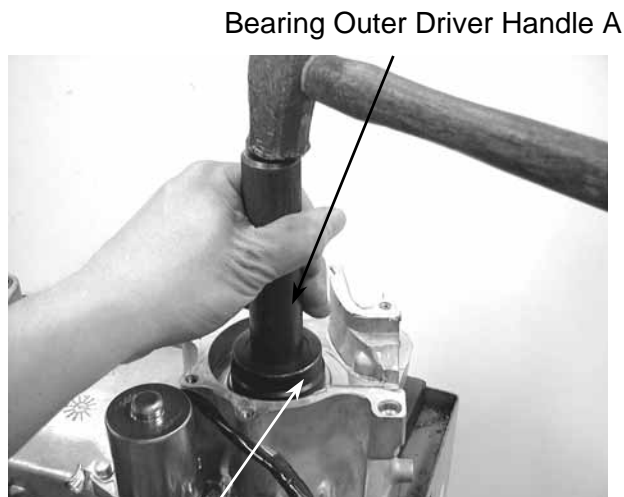

Bearing Outer Driver, 42x47mm
Pilot, 20mm

Install the crankshaft into the left crankcase.

*

- Apply KYMCO ULTRA motor oil or molybdenum disulfide to the crankshaft bearings and connecting rod big end.
- Apply grease to the lip of the oil seal and then install it.



CRANKCASE ASSEMBLY

Install the dowel pins and a new gasket to the crankcase mating surface.

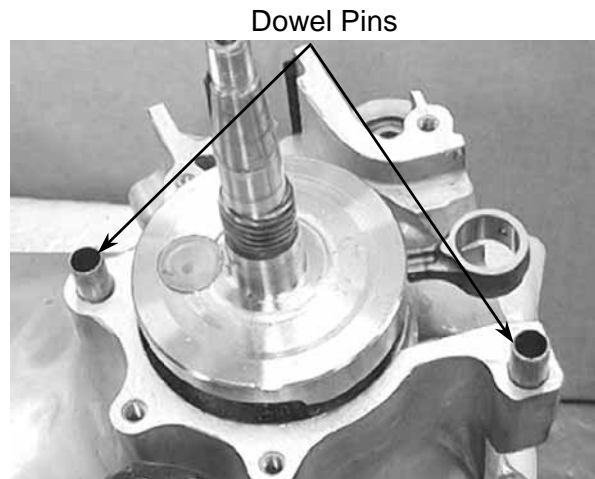

Assemble the crankcase halves.

Crankcase Assembly Tool

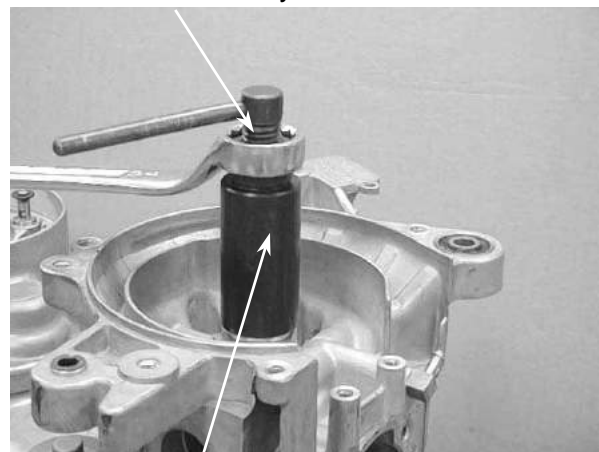

Crankcase Assembly Collar

The distance between the right crankcase oil seal and crankcase surface is about 12.5 ± 0.5 mm.

* When installing the oil seal, be careful to press it with even force.



The distance between the left crankcase oil seal and crankcase surface is about 1.0mm.

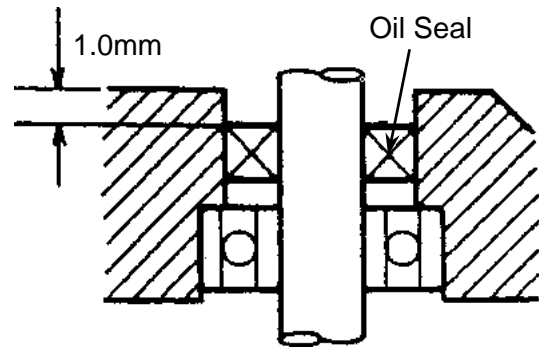

Install and tighten the crankcase attaching bolts.

* After assembly, check the crankshaft for smooth operation.



CARBURETOR

SERVICE INFORMATION	11- 2
TROUBLESHOOTING.....	11- 2
THROTTLE VALVE DISASSEMBLY	11- 3
THROTTLE VALVE INSTALLATION.....	11- 4
CARBURETOR REMOVAL	11- 5
AUTO BYSTARTER	11- 6
FLOAT CHAMBER	11- 8
FLOAT LEVEL INSPECTION	11-10
CARBURETOR INSTALLATION	11-11
AIR SCREW ADJUSTMENT	11-11
REED VALVE	11-12
FUEL TANK.....	11-13

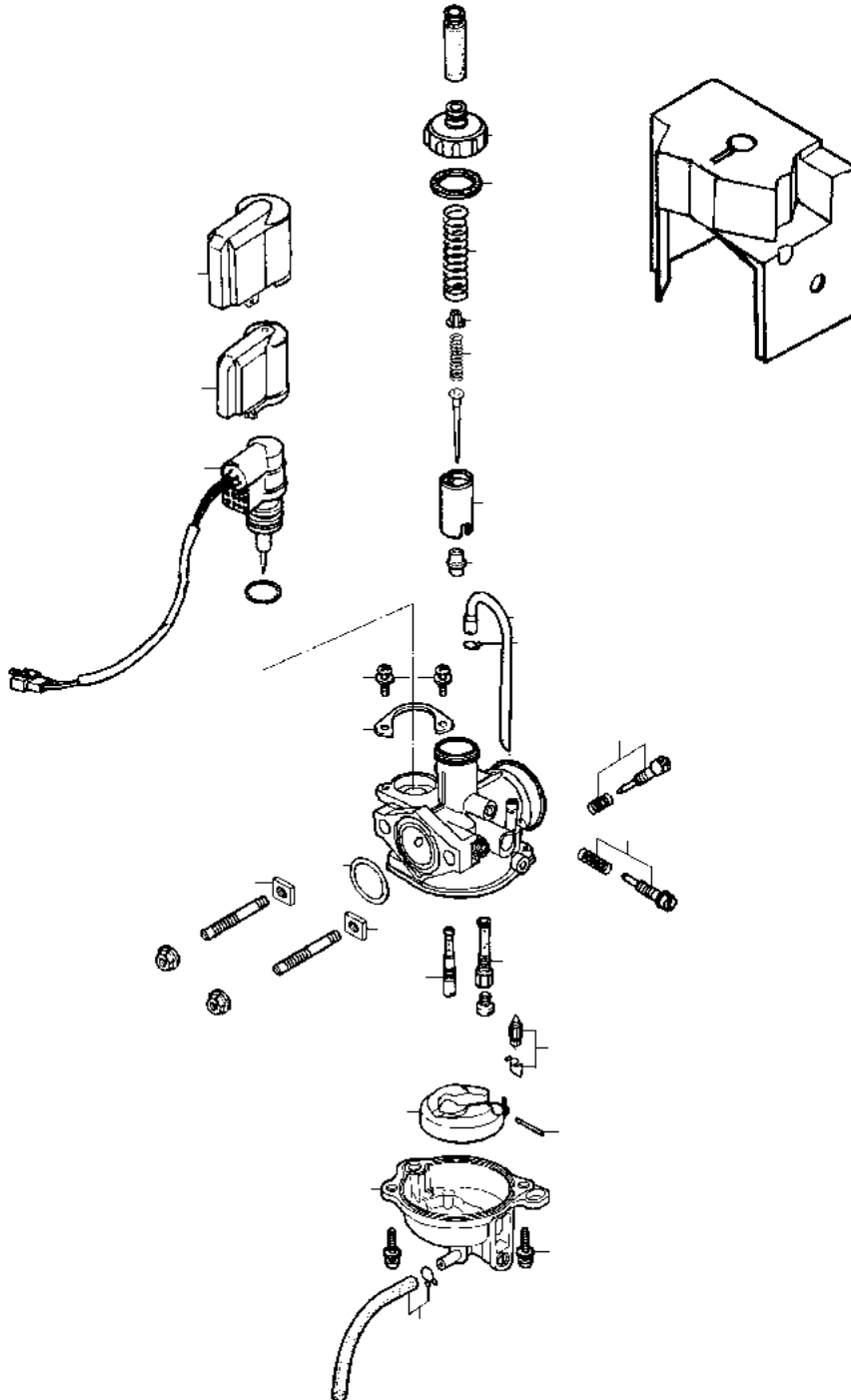

SERVICE INFORMATION

GENERAL INSTRUCTIONS

- When working with gasoline, keep away from sparks and flames..
- Note the locations of O-rings when disassembling and replace them with new ones during assembly.
- All cables, fuel lines and wires must be routed and secured at correct locations.
- Bleed air from the oil lines whenever they are disconnected.

SPECIFICATIONS

	SUPER8 50 2T
Venturi dia.	16mm
Identification number	PB
Float level	8.6mm
Main jet	#72
Slow jet	#35
Air screw opening	1¼ ± ½
Idle speed	1850±100rpm
Throttle grip free play	2~6mm

SPECIAL TOOL

Float level gauge

TROUBLESHOOTING

Engine does not start

- No fuel in tank
- Too much fuel getting to cylinder
- Clogged fuel filter
- Clogged air cleaner

Lean mixture

- Clogged fuel jets
- Clogged fuel cap vent
- Clogged fuel filter
- Bent, kinked or restricted fuel line

- Faulty float valve
- Float level too low
- Clogged air cleaner

Engine idles roughly, stalls or runs poorly

- Incorrect idle speed
- Ignition malfunction
- Compression too low
- Incorrectly adjusted air screw
- Incorrect float level
- Clogged air cleaner
- Intake air leaks
- Fuel contaminated
- Faulty reed valve
- Clogged fuel jets

Rich mixture

- Faulty float valve
- Float level too high
- Clogged air jets

THROTTLE VALVE DIS-ASSEMBLY

Remove the rear carrier. (⇒12-5)
Remove the met-in box. (⇒12-4)
Remove the rubber cover.
Loosen carburetor cap and the throttle valve.

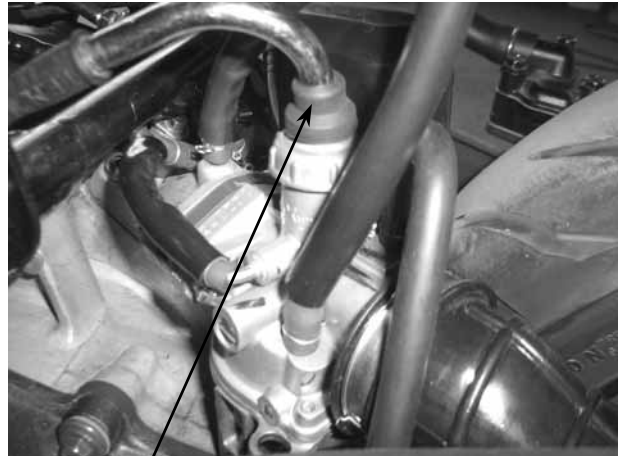

Rubber Cover

Disconnect the throttle cable from the throttle valve.



Throttle Valve

Remove the throttle valve spring, carburetor cap and rubber seal.

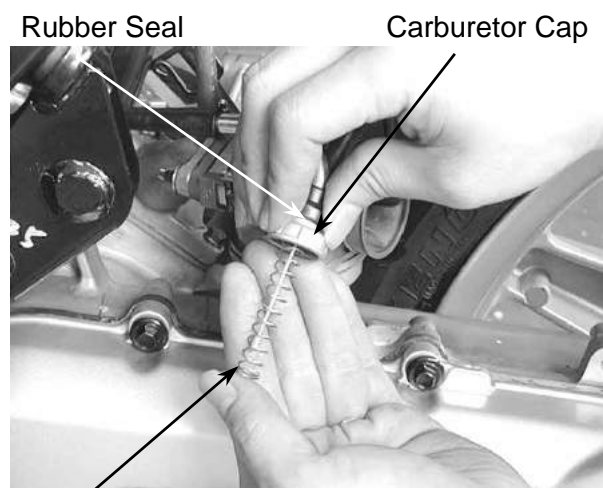

Rubber Seal

Carburetor Cap

Spring

Remove the jet needle by removing the needle clip.
Check the jet needle and throttle valve for wear or damage.

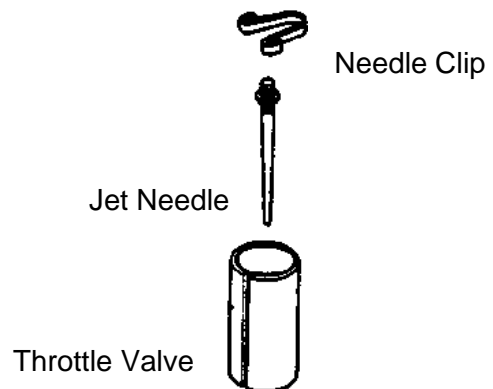

THROTTLE VALVE INSTALLATION

Install the jet needle on the throttle valve and secure with the needle clip.

Install the rubber seal on the throttle cable and then install the carburetor cap and throttle valve spring.

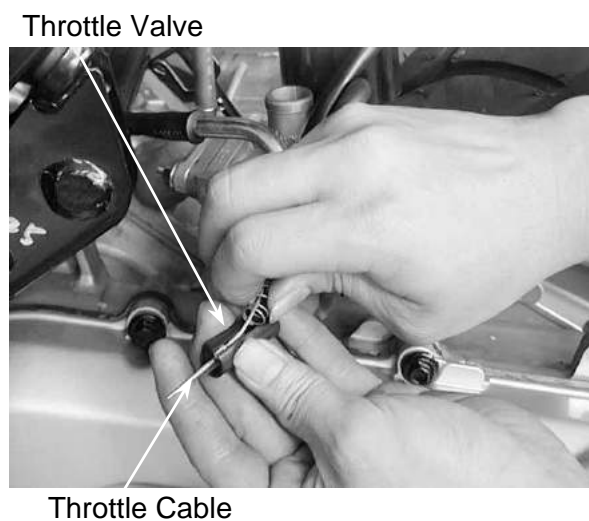
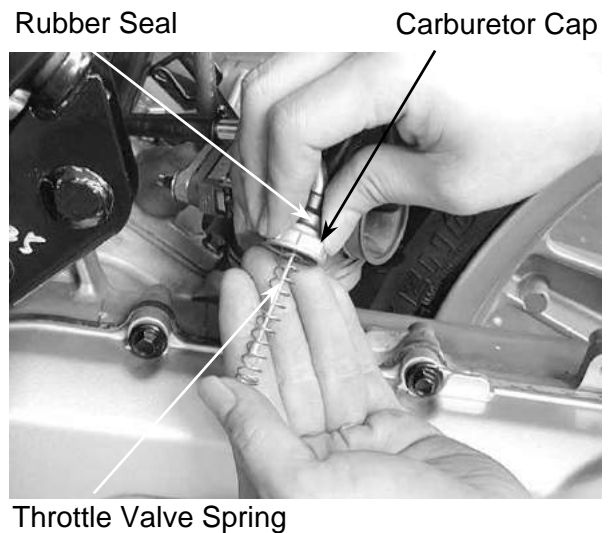

Connect the throttle cable to the throttle valve.

Install the throttle valve by aligning the groove in the throttle valve with the throttle stop screw.

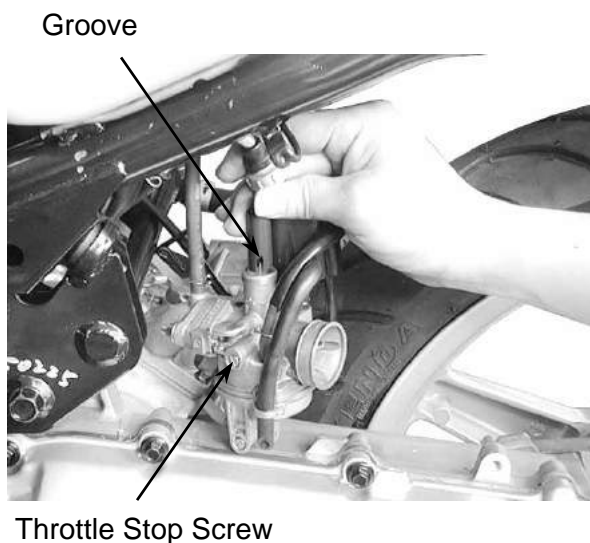

Tighten the carburetor cap.
After installation, perform the following adjustments and inspections.

- Throttle cable free play (⇒3-12)
- Idle speed adjustment (⇒3-11)

Install the met-in box.

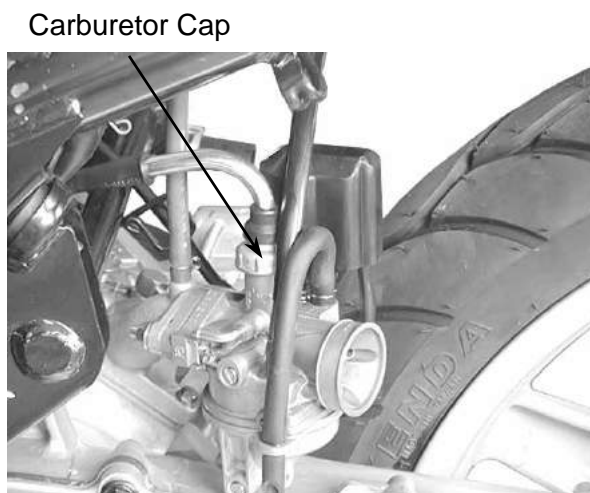

CARBURETOR REMOVAL

Remove the met-in box. (⇒12-4)
Remove the air cleaner by removing the air cleaner band screw and attaching bolts.
Disconnect the fuel tube.
Loosen the drain bolt to drain fuel from the carburetor.
Disconnect the auto bystarter wire connector.
Remove the two carburetor lock nuts.

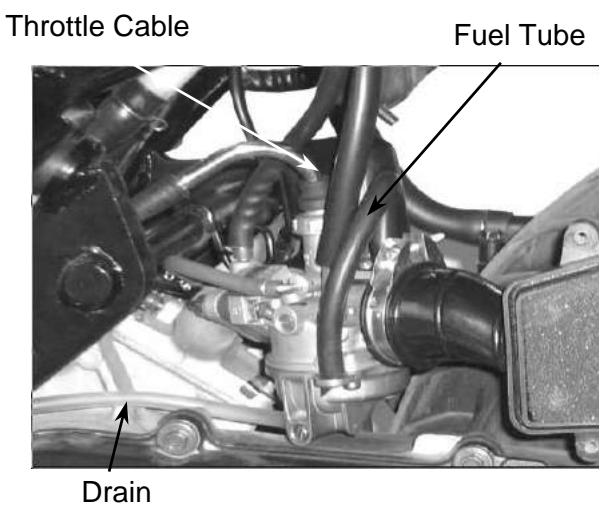

Remove the carburetor.

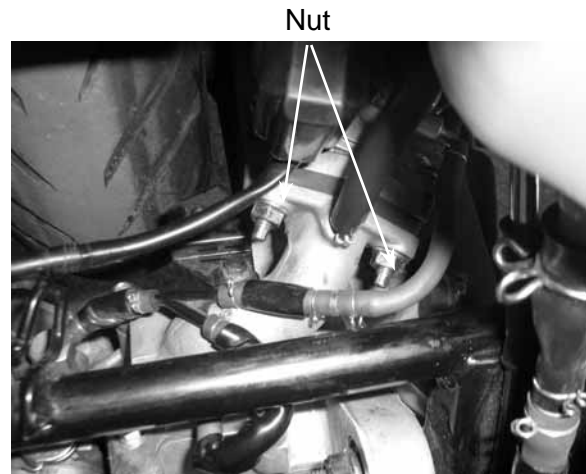

AUTO BYSTARTER

AUTO BYSTARTER INSPECTION

Measure the resistance between the auto bystarter wire terminals.

Resistance: 5Ω (10 minutes minimum after stopping the engine)

If the resistance exceeds 5Ω , replace the auto bystarter with a new one.



After the engine stops for 30 minutes, connect a hose to the fuel enriching circuit and blow the hose with mouth.

If air cannot be blown into the hose (clogged), the auto bystarter is faulty. Replace it with a new one.

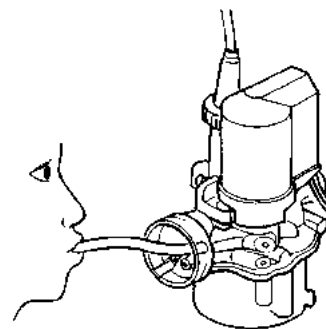

Connect the auto bystarter yellow wire to the battery positive (+) terminal and green/black wire to the battery negative (-) terminal and wait 5 minutes.

Connect a hose to the fuel enriching circuit and blow the hose with mouth.

If air can be blown into the hose, the auto bystarter is faulty and replace it with a new one.

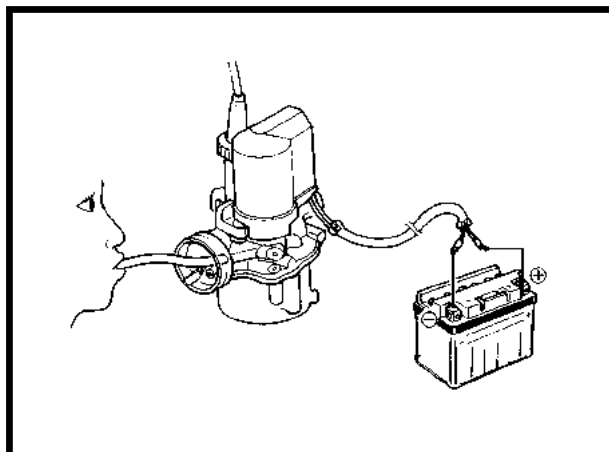

AUTO BYSTARTER REMOVAL

Remove the auto bystarter cover.
Remove the two auto bystarter set plate screws to remove the auto bystarter.

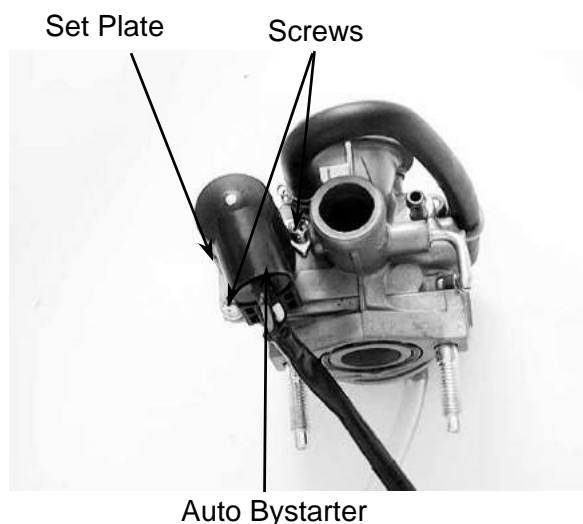

Check the auto bystarter valve and needle for wear or damage.
Check the O-ring for wear or damage.

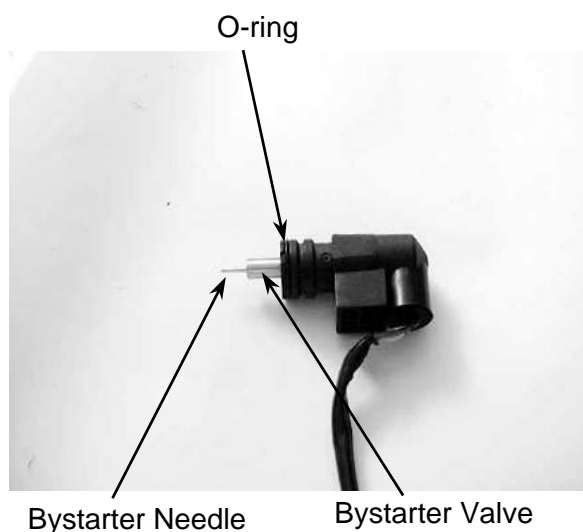

AUTO BYSTARTER INSTALLATION

Install the auto bystarter into the carburetor body until it bottoms..
Install the set plate and then tighten the two screws.

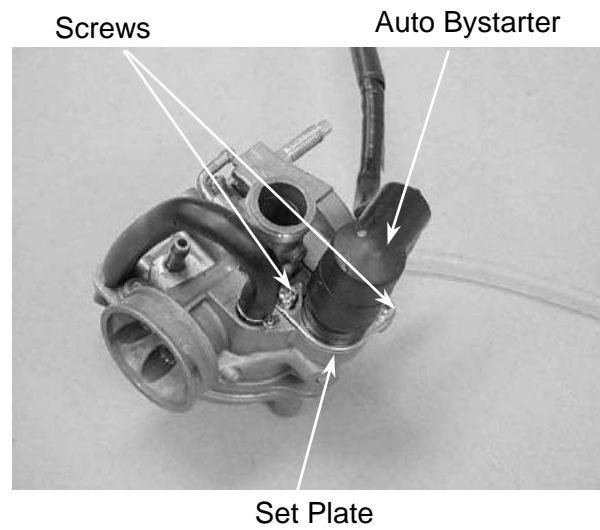

FLOAT CHAMBER

Remove the two float chamber screws and the float chamber.

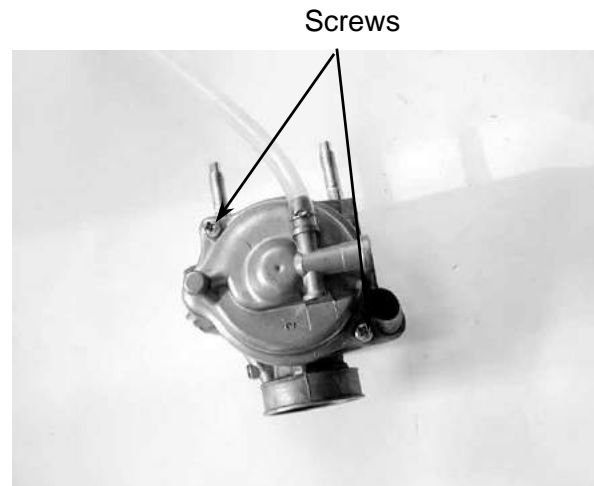

Remove the screw and O-ring.
Remove the float pin, float and float valve.

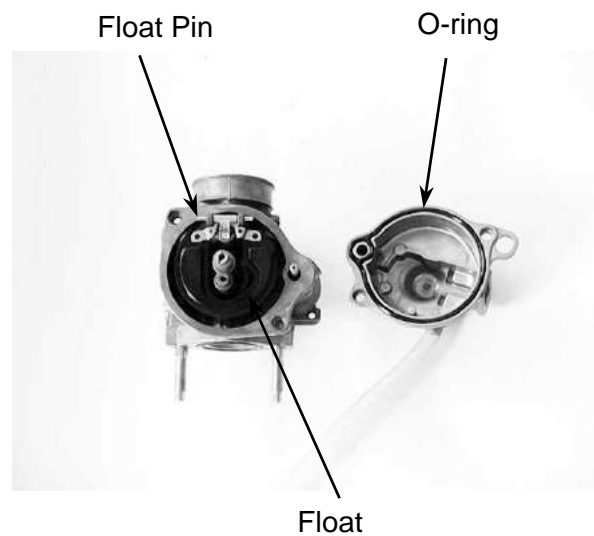

FLOAT/FLOAT VALVE INSPECTION

Inspect the float for damage or fuel inside the float.

Check the float valve seat for wear or damage.

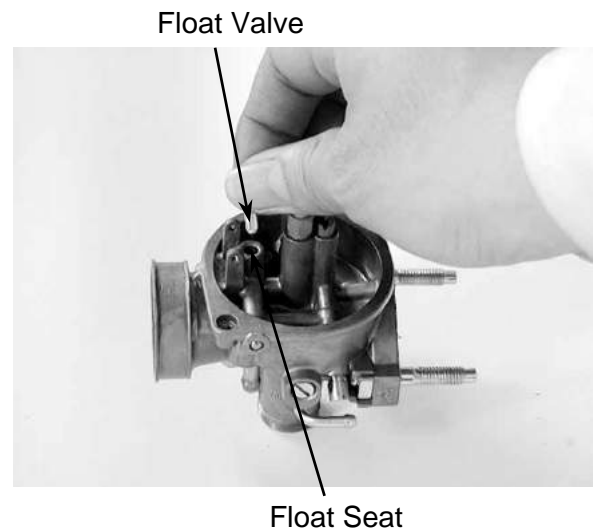

JETS/SCREWS REMOVAL

Before removing the throttle stop screw or air screw, record the number of rotations until it seats lightly. Then, remove them.

* Do not force the air screw against its seat to prevent damage.

Remove the main jet and needle jet holder.

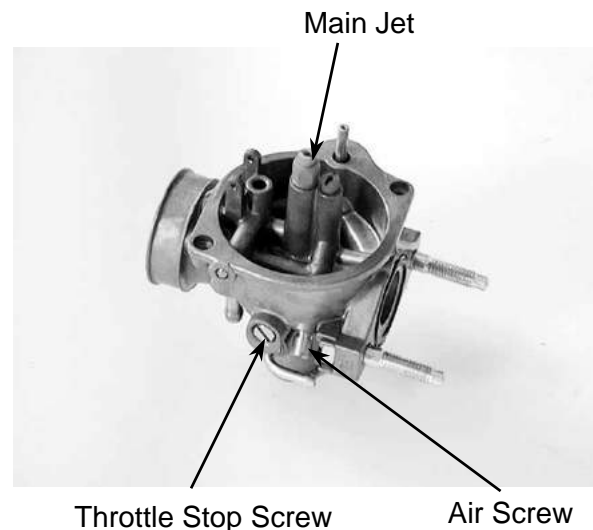

CARBURETOR PASSAGES CLEANING

Blow compressed air through all passages of the carburetor body with an air gun.

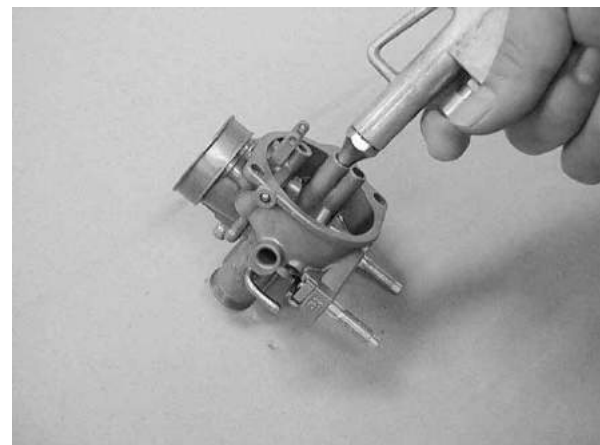

FLOAT CHAMBER ASSEMBLY

Install the main jet and needle jet holder.
Install the air screw and throttle stop screw according to the rotations recorded.

* If the air screw must be replaced, be sure to perform the air screw adjustment again.

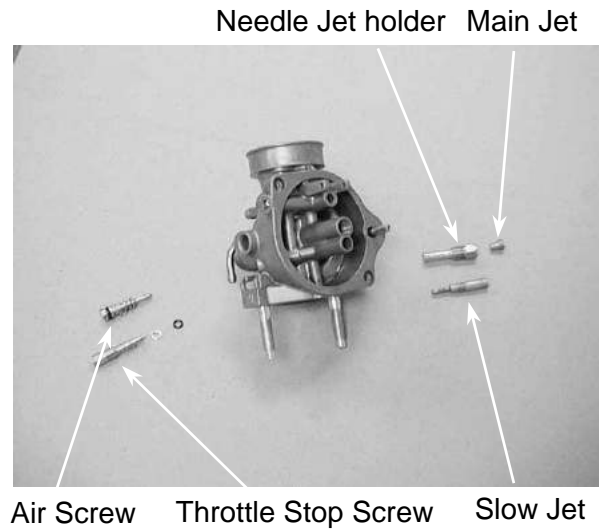

Install the float valve, float and float pin.
Tighten the float screw securely.

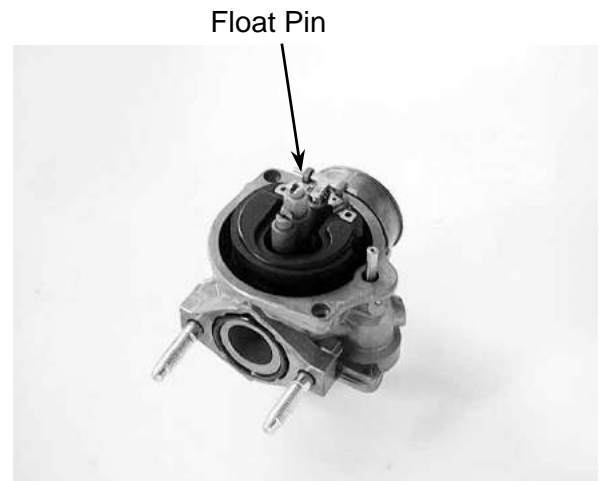

FLOAT LEVEL INSPECTION

Slightly tilt the carburetor and measure the float level with the float valve just connecting the float arm.

Float Level: 8.6mm

Replace the float if the level is out of the specified level range.

Install the O-ring.

Check the operation of the float and install the float chamber.

Tighten the screws.

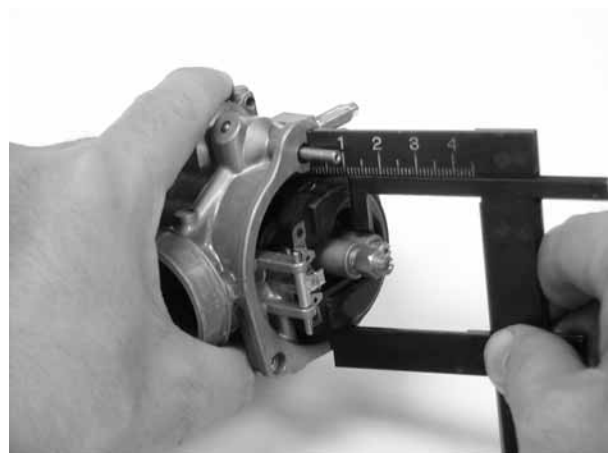

CARBURETOR INSTALLATION

- * When installation, do not allow foreign particles to enter the carburetor.

Check the carburetor insulator and O-ring for wear or damage.

Install the carburetor and insulator onto the intake manifold and tighten the two lock nuts.

Connect the fuel tube and auto bystarter wire connector.

- * Route the auto bystarter wire correctly and properly.

Install the carburetor cap. (⇒11-4)

Install the air cleaner onto the carburetor and tighten the band screw.

Install the met-in box. (⇒12-4)

AIR SCREW ADJUSTMENT

Remove the met-in box. (⇒12-4)

- * Warm up the engine before air screw adjustment.

Turn the air screw clockwise until it seats lightly and back it to the specification given.

Air Screw Opening:

: $1\frac{1}{4} \pm \frac{1}{2}$ turns

Start the engine and turn the air screw in or out slowly to obtain the highest engine speed.

- * Do not force the air screw against its seat to prevent damage.

Turn the throttle stop screw to obtain the specified idle speed.

Idle Speed:

: 1950 ± 100 rpm

Slightly increase the engine speed and make sure that the engine does not miss or run erratic.

If the adjustment of the air screw within the range of $\pm \frac{1}{2}$ turn makes no difference to the engine performance, check other related items.

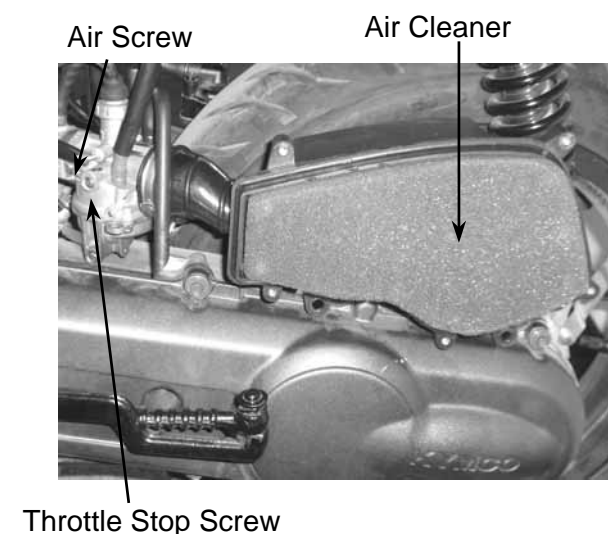
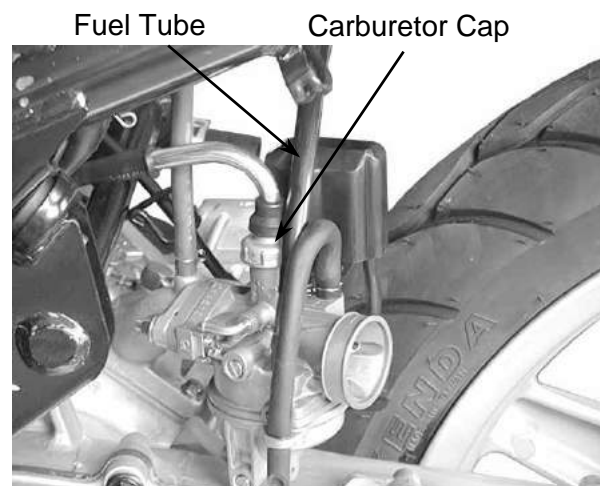
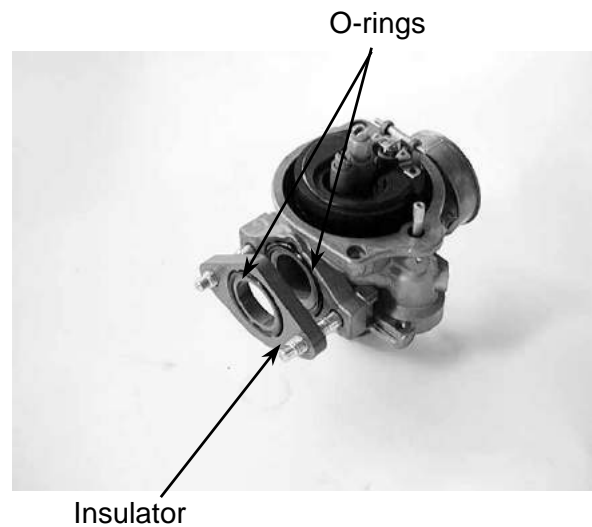

REED VALVE

REMOVAL

Remove the rear carrier.
Remove the frame body cover.
Remove the four intake manifold bolts and gasket.
Remove the reed valve and gasket.

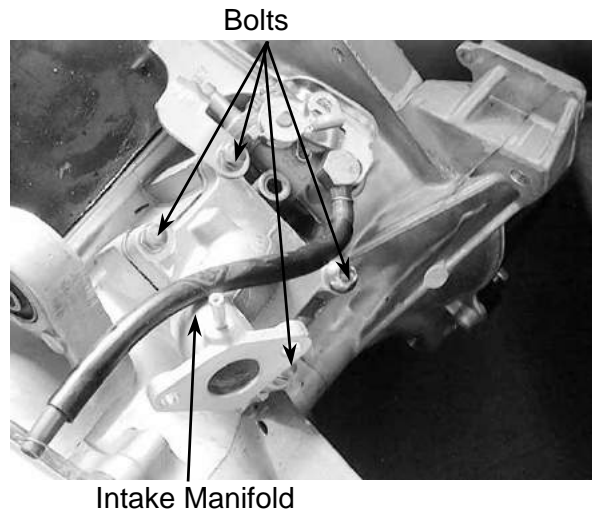

INSPECTION

Check the reed valve for damaged or weak reeds.
Check the reed valve seat for cracks, damage or clearance between the seat and reed.
Replace the valve if necessary.

* Do not disassemble or bend the reed stopper. To do so can cause loss of engine power and engine damage. If any of the stopper, reed or valve seat is faulty, replace them as a unit.

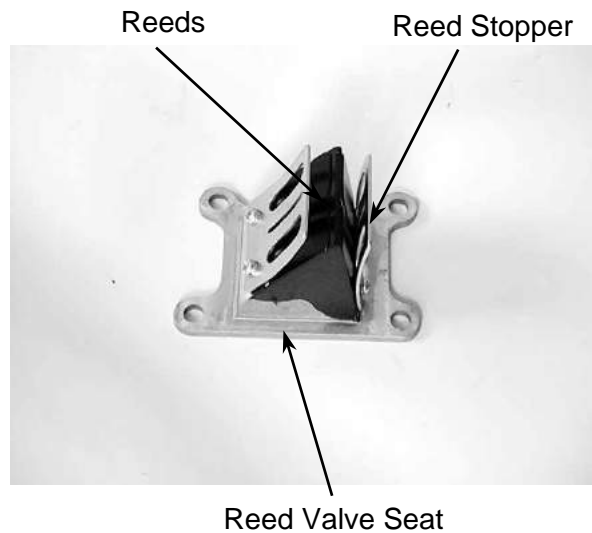

INSTALLATION

Install the reed valve in the reverse order of removal.

*

- Install a new gasket with the gasket indentation aligned with the reed valve.
- After installation, check for intake air leaks.

FUEL TANK

REMOVAL

- Remove the met-in box. (⇒12-4)
- Remove the frame body cover. (⇒12-5)
- Remove the rear carrier. (⇒12-5)
- Disconnect the fuel tube and vacuum tube at the auto fuel tank.
- Disconnect the fuel unit wire connector.
- Remove the fuel tank holder mounting bolts and fuel tank.
- Inspect the fuel unit. (⇒16-2)
- Replace the fuel unit if necessary.

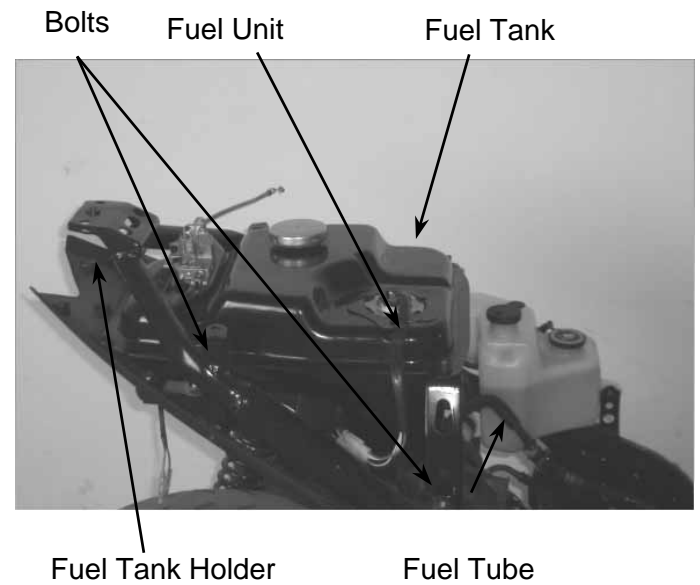

ASSEMBLY

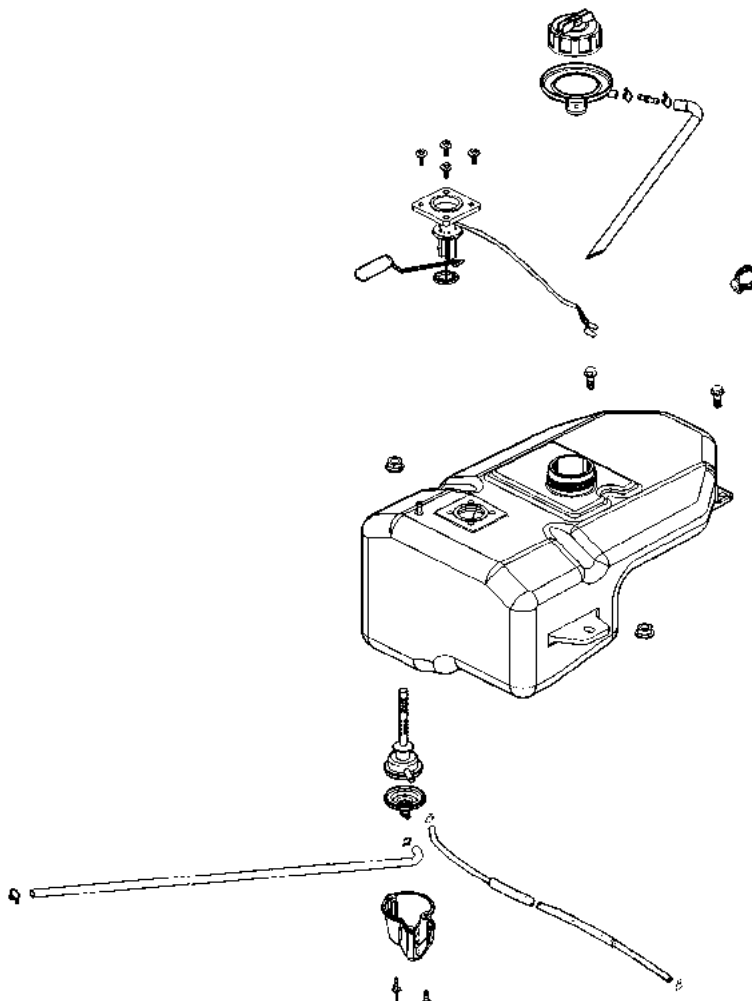

FRAME COVERS

SERVICE INFORMATION 12-2
FRAME COVERS REMOVAL/INSTALLATION 12-3
EXHAUST MUFFLER REMOVAL 12-8

12. FRAME COVERS

SUPER8 50 2T

ASSEMBLY DRAWING

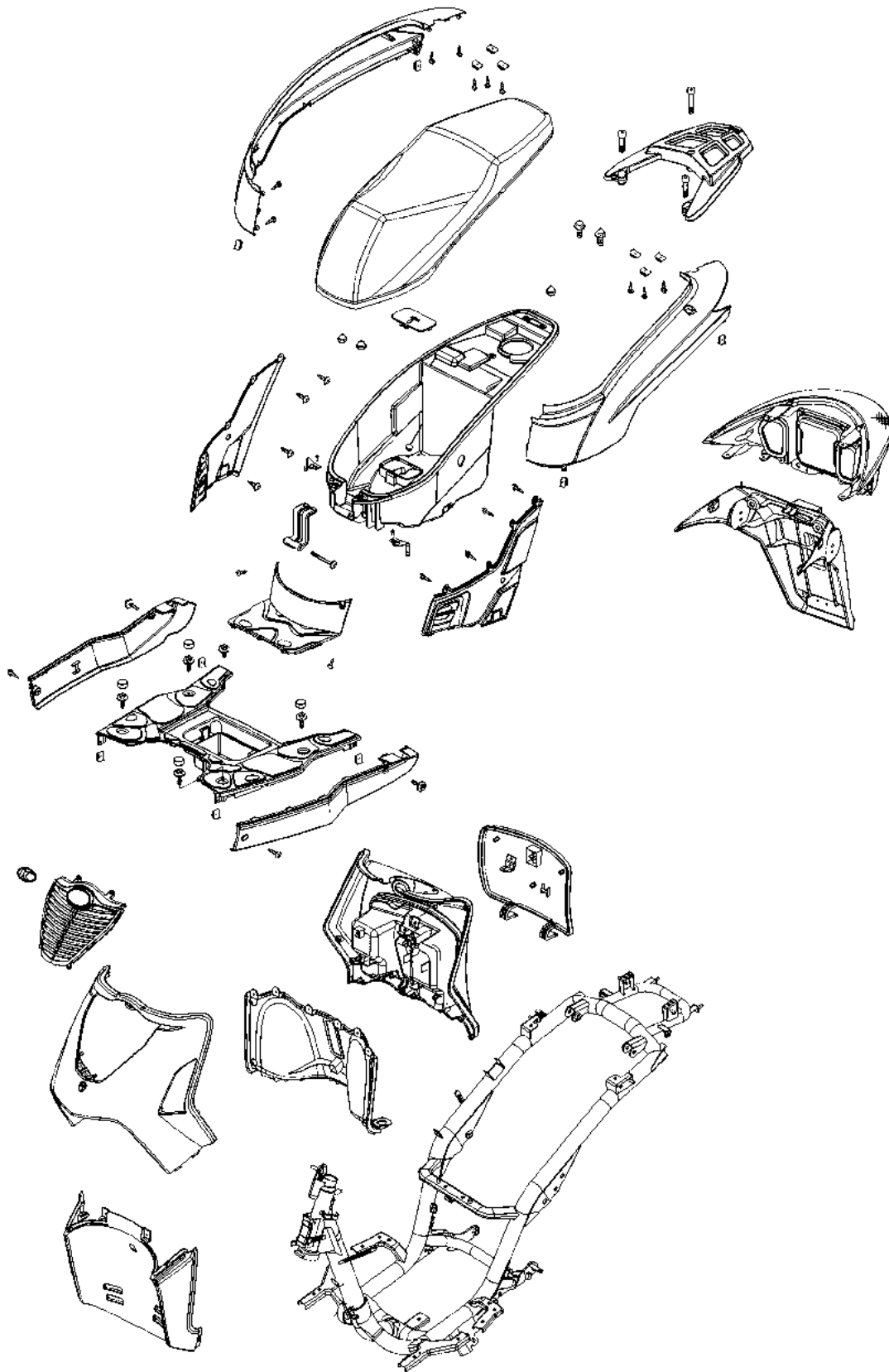

SERVICE INFORMATION

- When removing frame covers, use care not to pull them by force because the cover joint claws may be damaged.

Items Related for Removal

- Handlebar front cover ——— Headlight wire
- Front cover ———
- Handlebar rear cover ——— Speedometer cable and instrument light wire connectors, etc.
- Frame body cover ——— Met-in box, rear carrier, rear fender.
- Floor board ——— frame body cover.
- Front tool box ——— Front cover, battery, floor board .

FRAME COVERS REMOVAL

REAR CARRIER

Remove the met-in box.
First remove the two bolts and four nuts
attaching the met-in box.
Remove the met-in box



Remove the three bolts attaching the rear
carrier.
Remove the rear carrier.



FRAME BODY COVER REMOVAL

Remove the one nuts attaching the rear
protective cover.
Remove the rear protective cover



Remove the two screws on the bottom of the center cover.
Remove the center cover.
Remove the body cover.

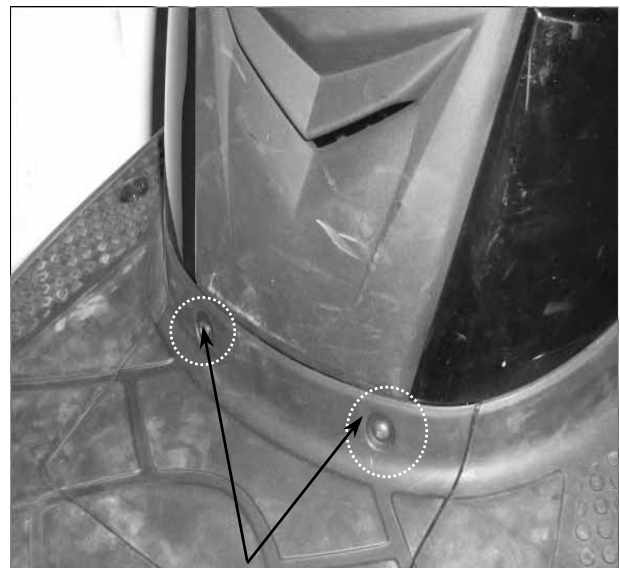

Screws

FLOOR-FOOT REMOVAL

Remove the screws attaching the right and left side covers.
Remove the right and left side covers by pulling them outward.

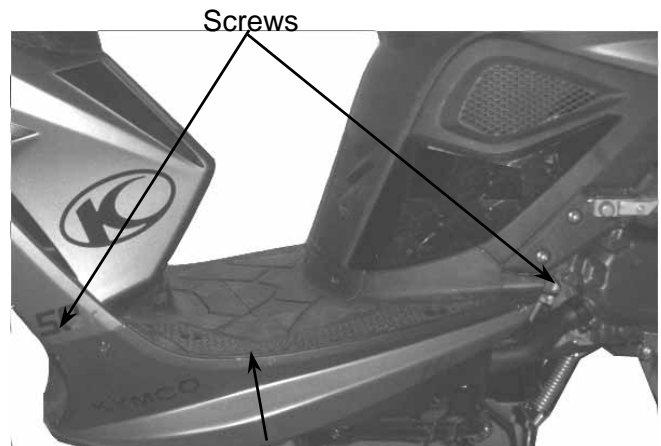

Screws

Side Cover

Disconnect the battery wire.
Remove the battery.



Battery Wire

Battery

Remove the floor mat.
Remove the center cover. (⇒12-3)
Remove the screws and bolts attaching the front right and left side covers.
Remove the four bolts attaching the floor-foot.
Remove the floor-foot.
The installation sequence is the reverse of removal.

Bolts



LEG SHIELD LOW REMOVAL

Remove the met-in box.
Remove the body cover.
Remove the floor-foot.
Remove the front upper cover.
Remove the eight screws attaching the leg shield low.
Disconnect the leg shield low with the cowl under cover.
The installation sequence is the reverse of removal.

Screw

Front Cover

Bolts



Leg Shield Low



Screws

Remove the four bolts attaching the left and right rear step.
Remove the rear step

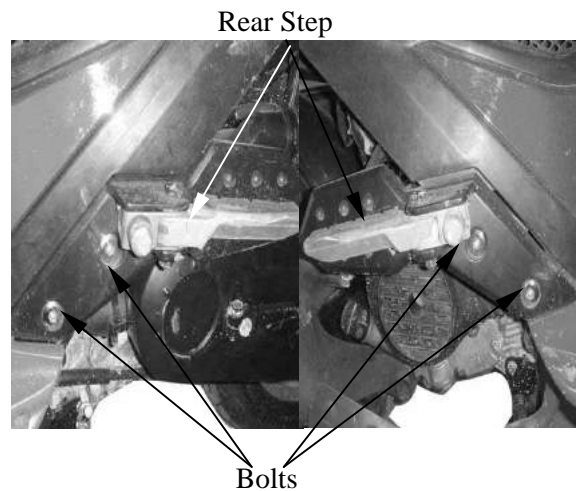

WINDSHIELD REMOVAL

Remove the four bolts attaching the front windshield out cover.
Remove the windshield out cover.
Remove the windshield.

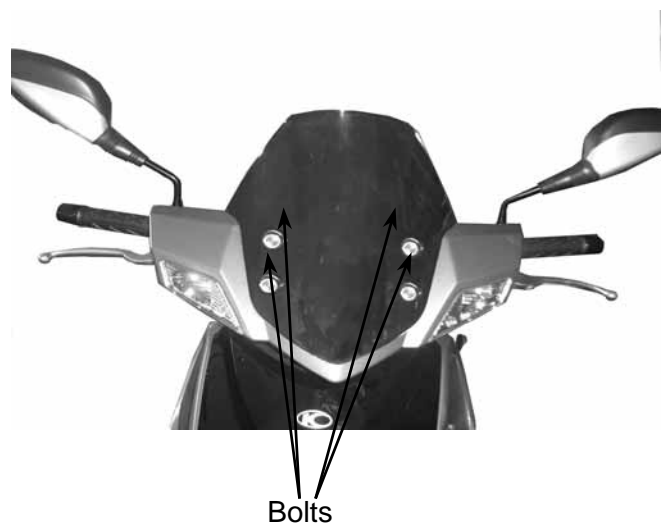

HANDLEBAR COVER REMOVAL

First remove the windshield.
Remove the four screws and two bolts attaching the handlebar rear cover.
Remove the handlebar rear cover.
The installation sequence is the reverse of removal.

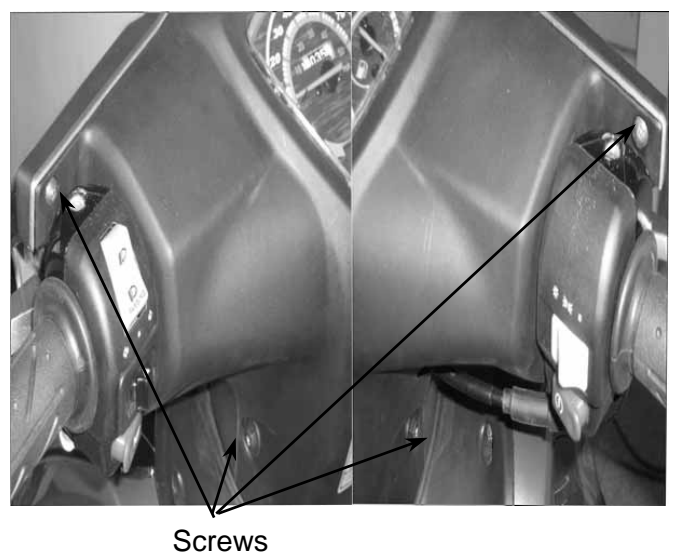

Remove the four nuts attaching the handlebar cover
Remove the handlebar cover.
The installation sequence is the reverse of removal.

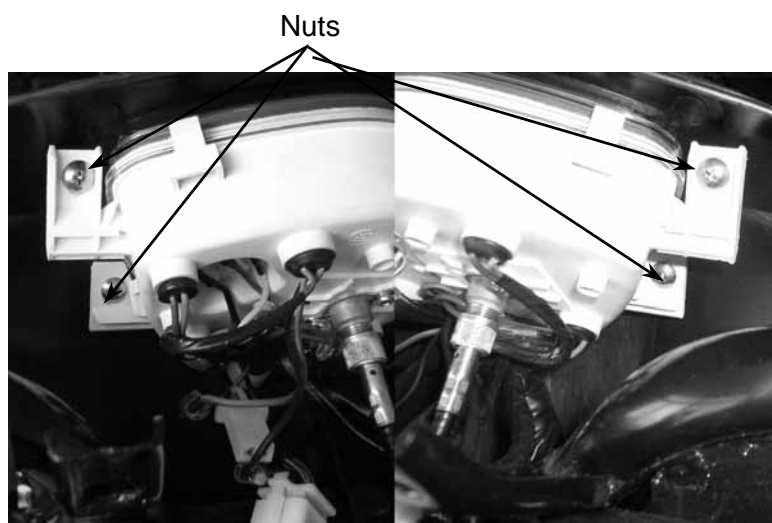

BOTTOM COVER REMOVAL

Remove the four bolts attaching the bottom cover.
Remove the bottom cover.

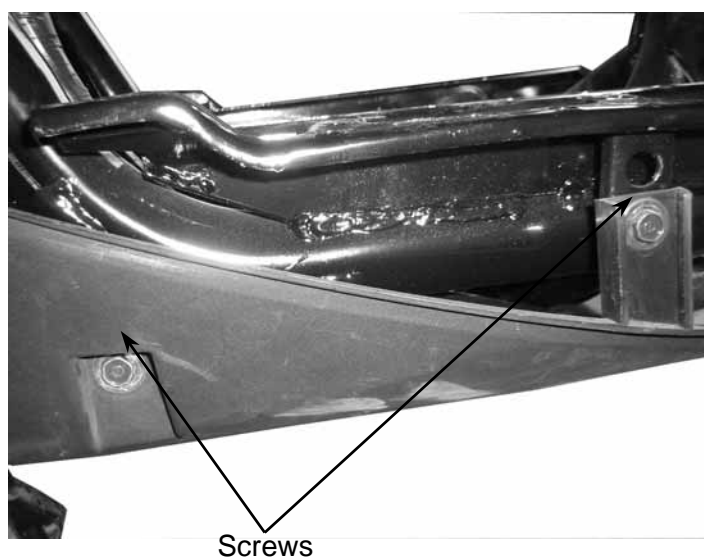

FRONT FENDER AND UNDER COWL REMOVAL

Remove the two on the under cowl.
Remove the under cowl.

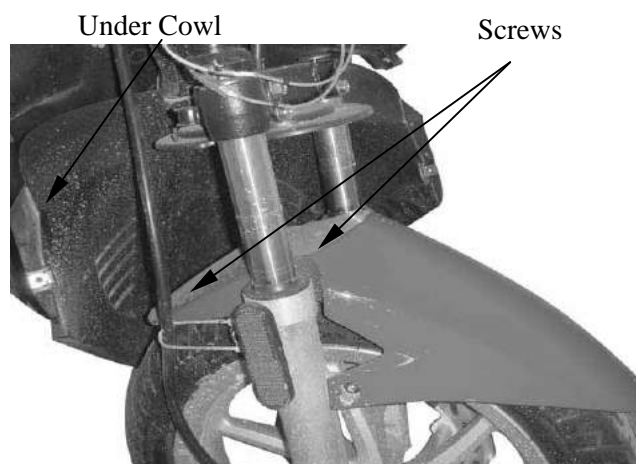

Clip Body. Lid Leg Shield.

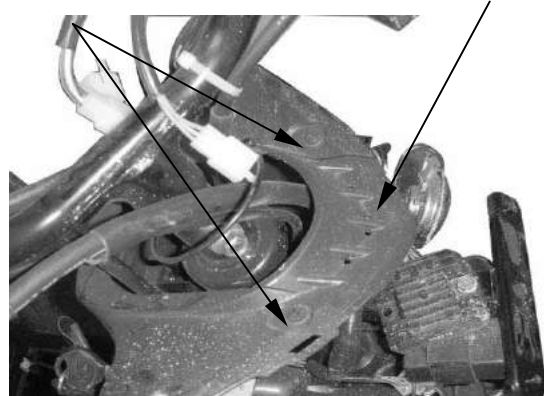

Remove the L/R side bolts attaching the front fender and front fender.

Nuts

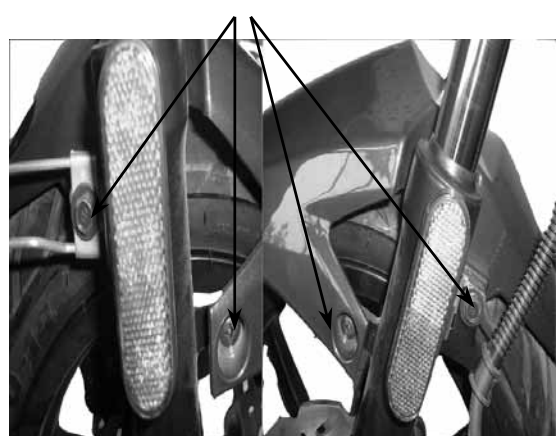

EXHAUST MUFFLER REMOVAL

Remove two lock nuts from joint in the exhaust muffler.

Remove the exhaust muffler two lock bolts to remove the exhaust muffler.

Remove the exhaust muffler joint packing collar.

The installation sequence is the reverse of removal.

Torque:

Exhaust muffler joint lock nut: 2.2kg-m

Exhaust muffler lock bolt: 3.3kg-m

Lock Bolts

Lock Nut

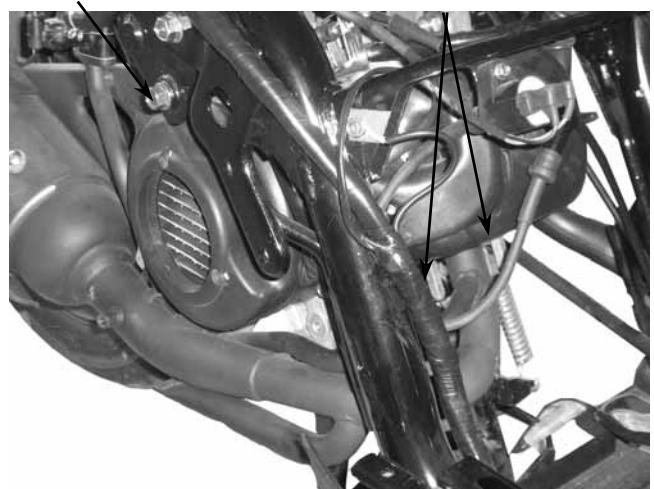

FRONT WHEEL/FRONT BRAKE/FRONT SUSPENSION

SERVICE INFORMATION 13-2

TROUBLESHOOTING..... 13-3

FRONT WHEEL..... 13-4

HYDRAULIC BRAKE DRAWING..... 13-7

HYDRAULIC BRAKE 13-8

FRONT SHOCK ABSORBER 13-13

STEERING HANDLEBAR 13-14

STEERING STEM..... 13-15

**13. STEERING HANDLEBAR/FRONT WHEEL/FRONT BRAKE/FRONT SHOCK
ABSORBER/FRONT FORK** **SUPER8 50 2T**

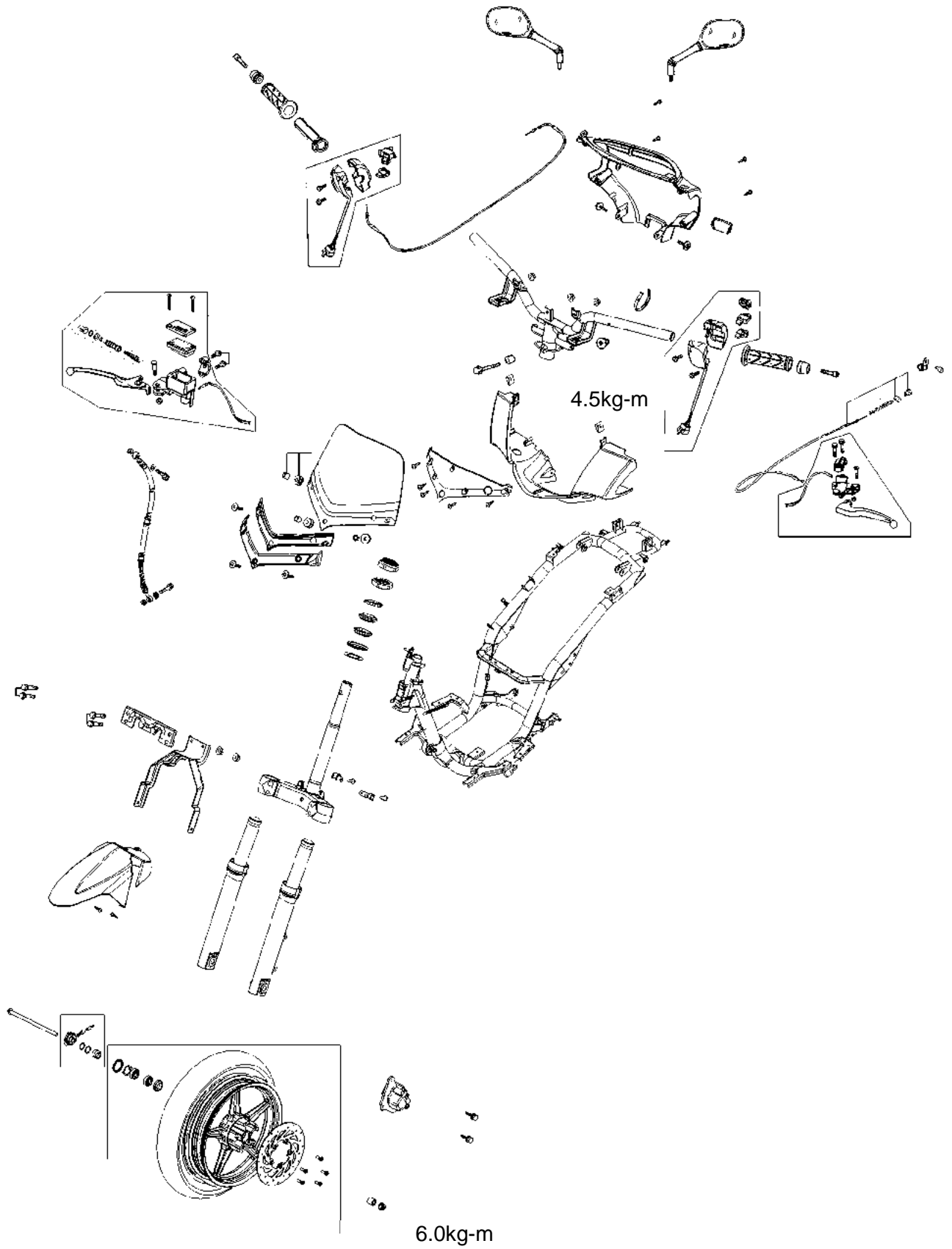

13. STEERING HANDLEBAR/FRONT WHEEL/FRONT BRAKE/FRONT SHOCK ABSORBER/FRONT FORK SUPER8 50 2T

SERVICE INFORMATION

GENERAL INSTRUCTIONS

- Remove the motorcycle front wheel off the ground and be careful to prevent the motorcycle from falling down.
- During servicing, keep oil or grease off the brake drum and brake linings.
- Contaminated brake disk or brake pads reduce stopping power. Clean the contaminated brake disk with high-performance brake degreaser and replace the brake pads.
- Do not use brake fluid for cleaning.
- Bleed air from the brake system if the brake system is removed or the brake is soft.
- Do not allow any foreign matters to enter the brake system when filling it with brake fluid.
- Brake fluid will damage painted surfaces and plastic parts. When servicing the brake system, use shop towels to cover and protect rubber, plastic parts and coated surfaces. Wipe off any spilled brake fluid with a clean shop towel.
- Inspect the brake system before riding.

SPECIFICATIONS

Item		Standard (mm)	Service Limit (mm)
Axle shaft runout		—	0.2
Front wheel rim runout	Radial	—	2.0
	Axial	—	2.0
Front brake lining thickness		5.5	2.75
Front shock absorber spring free length		260	252
Brake disk thickness		3.2~3.5	3.0
Brake disk runout		—	0.25
Brake master cylinder I.D.		12.700~12.743	12.75
Brake master cylinder piston O.D.		12.657~12.684	12.64
Brake caliper piston O.D.		33.910~33.934	33.901
Brake caliper cylinder I.D.		33.90~33.990	34.01

TORQUE VALUES

Steering stem bolt	4.0~5.0kg-m	Brake caliper bleed valve	0.6kg-m
Steering stem lock nut	7.0~8.0kg-m	Brake fluid tube bolt	3.0~4.0kg-m
Steering top cone race	0.5~1.3kg-m	Brake pad pin bolt	1.5~2.0kg-m
Front shock absorber bolt	2.0~2.5kg-m	Brake caliper bolt	2.9~3.5kg-m
Front axle nut	5.0~7.0kg-m	Brake master cylinder bolt	1.0~1.4kg-m

13. STEERING HANDLEBAR/FRONT WHEEL/FRONT BRAKE/FRONT SHOCK ABSORBER/FRONT FORK

SUPER8 50 2T

SPECIAL TOOLS

Lock nut wrench

Outer driver, 28x30mm

Ball race remover

Pliers (close)

Bearing remover head, 10mm

Driver handle A

Pilot, 10mm

Outer driver, 37x40mm

Bearing remover

TROUBLESHOOTING

Hard steering (heavy)

- Excessively tightened steering stem top cone race
- Broken steering balls
- Insufficient tire pressure

Steers to one side or does not track straight

- Uneven front shock absorbers
- Bent front fork
- Bent front axle or uneven tire

Poor brake performance

- Incorrectly adjusted brake
- Worn brake linings
- Contaminated brake lining surface
- Worn brake shoes at cam contacting area
- Worn brake drum
- Poorly connected brake arm

Poor brake performance (Disk Brake)

- Air in brake system
- Deteriorated brake fluid
- Contaminated brake pads and brake disk
- Worn brake pads
- Worn brake master cylinder piston oil seal
- Clogged brake fluid line
- Deformed brake disk
- Unevenly worn brake caliper

Front wheel wobbling

- Bent rim
- Excessive wheel bearing play
- Bent spoke plate
- Faulty tire
- Improperly tightened axle nut

Soft front shock absorber

- Weak shock springs
- Insufficient damper oil

Front shock absorber noise

- Slider bending
- Loose fork fasteners
- Lack of lubrication

13. STEERING HANDLEBAR/FRONT WHEEL/FRONT BRAKE/FRONT SHOCK ABSORBER/FRONT FORK

SUPER8 50 2T

FRONT WHEEL

REMOVAL

Remove the motorcycle front wheel off the ground.
Disconnect the speedometer cable.

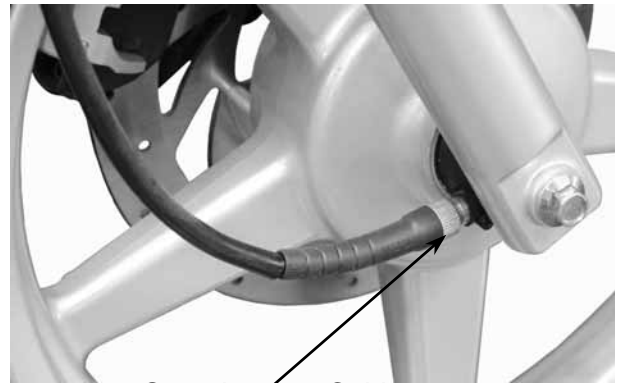

Speedometer Cable

Remove the front axle nut and pull out the axle.
Remove the front wheel.
Remove the front brake panel.

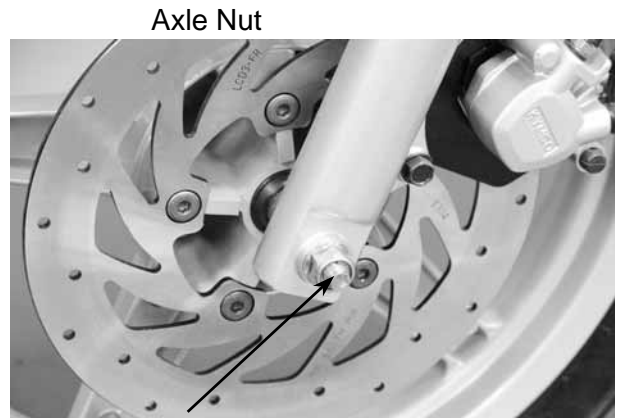

Axle Nut

Axle Shaft

INSPECTION

AXLE RUNOUT

Set the axle in V blocks and measure the runout using a dial gauge.
The actual runout is 1/2 of the total indicator reading.

Service Limit: 0.2mm replace if over

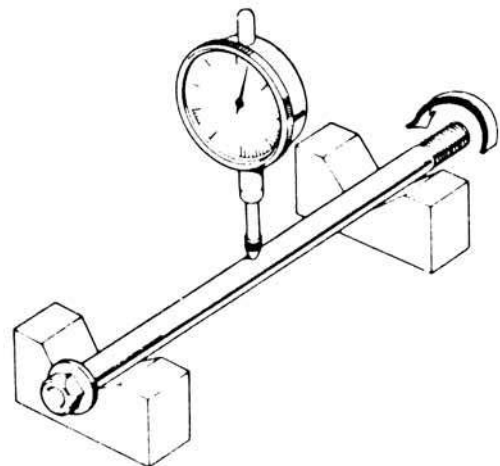

WHEEL RIM

Check the wheel rim run-out.

Service Limits:

Radial: 2.0mm replace if over

Axial: 2.0mm replace if over

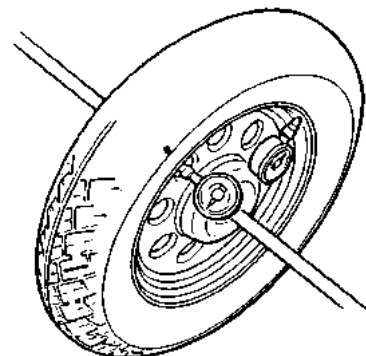

13. STEERING HANDLEBAR/FRONT WHEEL/FRONT BRAKE/FRONT SHOCK ABSORBER/FRONT FORK

SUPER8 50 2T

FRONT WHEEL BEARING

Remove the side collar and dust seal.

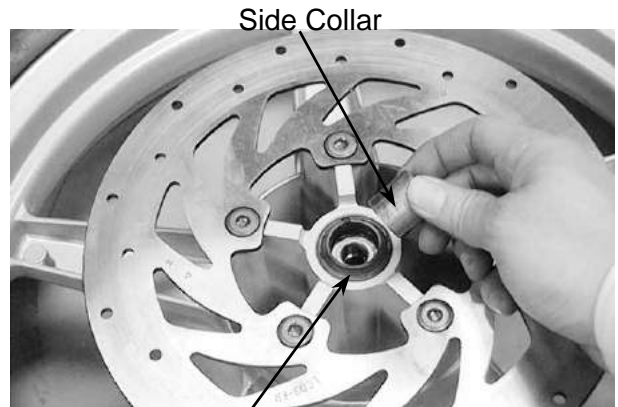

Dust Seal

Turn the inner race of each bearing with your finger to see if they turn smoothly and quietly. Also check if the outer race fits tightly in the hub.

Replace the bearings if the races do not turn smoothly, quietly, or if they fit loosely in the hub.



Wheel Bearing

BEARING REPLACEMENT

Remove the front wheel bearings and distance collar.

Special

Bearing Remover

Bearing Remover Head, 12mm

Pack all bearing cavities with grease.

Drive in the left bearing.

Install the distance collar.

Drive in the right bearing.

*

- Do not allow the bearings to tilt while driving them in.
- Drive in the bearing squarely with the sealed end facing out.

Special

Driver handle A

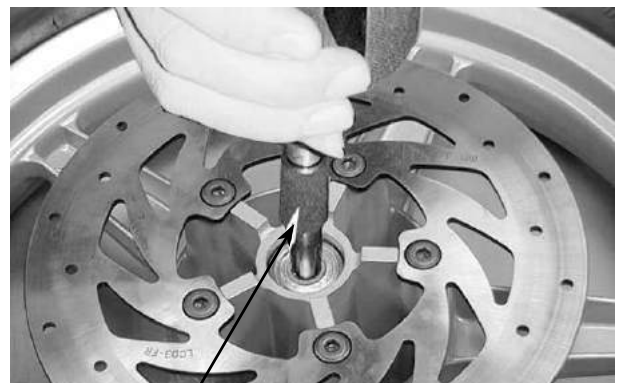

Bearing Remover



Driver Handle A

13. STEERING HANDLEBAR/FRONT WHEEL/FRONT BRAKE/FRONT SHOCK ABSORBER/FRONT FORK

SUPER8 50 2T

Apply grease to a new dust seal lip and install the dust seal.
Install the side collar.



INSTALLATION

Apply grease to the brake panel dust seal lip.
Apply grease to the speedometer gear engaging and sliding parts.
Install the brake panel by aligning the speedometer retaining pawls with the hub cutouts.

* If not aligned, the retaining pawl will be deformed when the axle nut is tightened.
After installing the axle, turn the wheel to make sure that the speedometer drive shaft rotates freely.

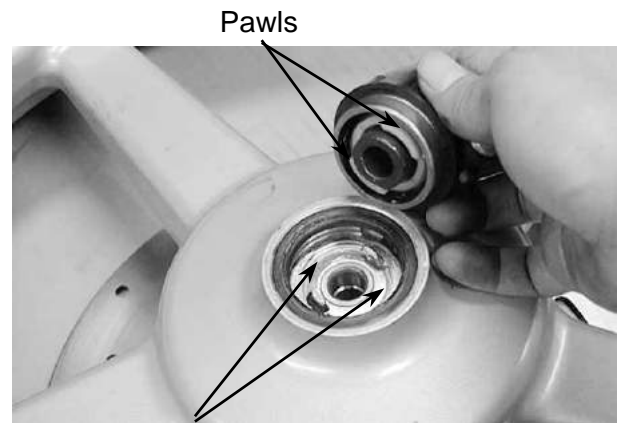

Apply a thin coat of grease to the axle shaft.
Install the front wheel by aligning the brake panel groove with the front fork tab.
Insert the axle shaft.
Install and tighten the axle nut.

Torque: 5.0~7.0kg-m

Install the front brake cable and rotate the front tire to check the speedometer if performed.

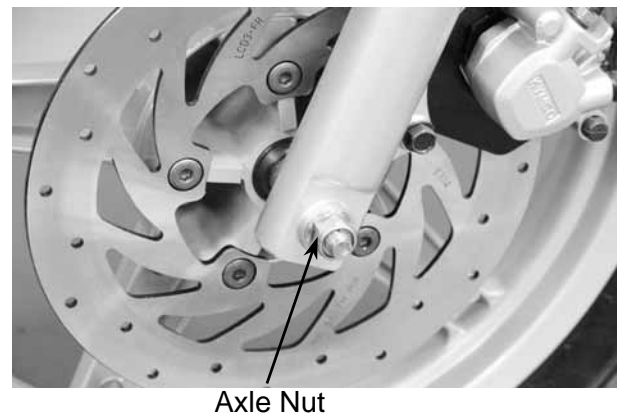

Connect the speedometer cable.

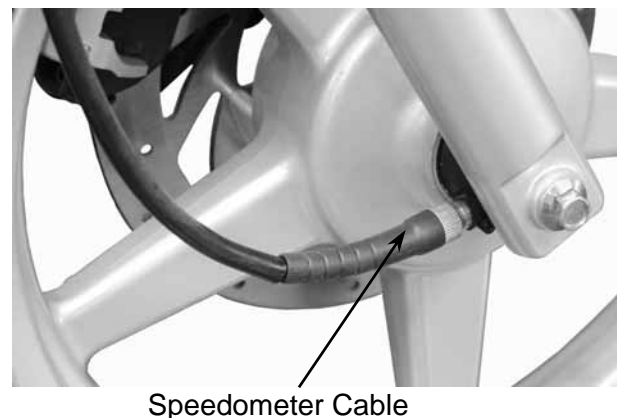

13. STEERING HANDLEBAR/FRONT WHEEL/FRONT BRAKE/FRONT SHOCK ABSORBER/FRONT FORK

SUPER8 50 2T

HYDRAULIC BRAKE DRAWING

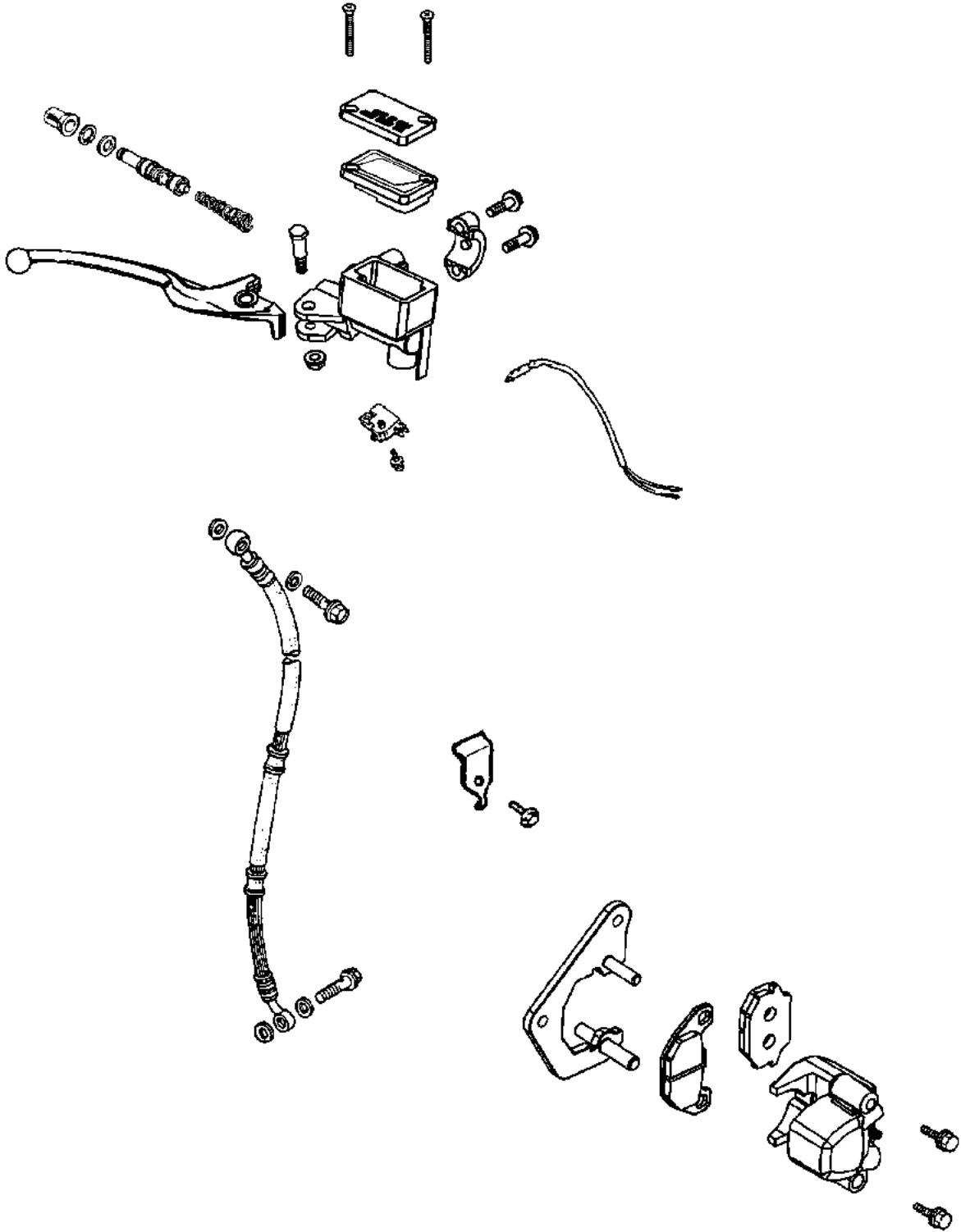

13. STEERING HANDLEBAR/FRONT WHEEL/FRONT BRAKE/FRONT SHOCK ABSORBER/FRONT FORK

SUPER8 50 2T

HYDRAULIC BRAKE (FRONT BRAKE)

BRAKE FLUID REPLACEMENT/AIR BLEEDING

Check the brake fluid level on level ground.

*

- When operating the brake lever, the brake reservoir cap must be tightened securely to avoid splash of brake fluid.
- When servicing the brake system, use shop towels to cover plastic parts and coated surfaces to avoid damage caused by splash of brake fluid.



BRAKE FLUID BLEEDING

In order to avoid spilling brake fluid, connect a transparent hose to the bleed valve.



Warning

Spilled brake fluid on brake pads or brake disk reduces stopping power. Clean the brake pads and brake disk with a high-performance brake

Fully apply the brake lever and then loosen the brake caliper bleed valve to drain the brake fluid until there is no air bubbles in the brake fluid. Then, tighten the bleed valve. Repeat these steps until the brake system is free of air.

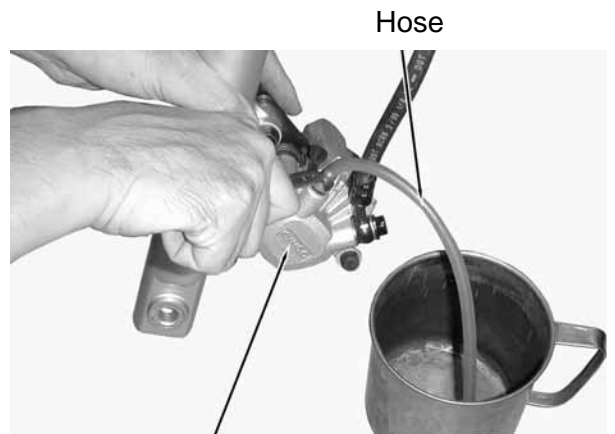

Front Brake Caliper Reservoir

BRAKE FLUID REFILLING

Add DOT-3 brake fluid to the brake reservoir.

*

- When bleeding, be careful not to allow air in the brake reservoir flowing into the brake system.
- Never use dirty or unspecified brake fluid or mix different brake fluids because it will damage the brake system.



Make sure to bleed air from the brake system.

BRAKE PAD/DISK REPLACEMENT

*

The brake pads must be replaced as a set to ensure the balance of the brake

Remove the two bolts attaching the brake caliper.
Remove the brake caliper.
Compress the brake caliper seat, and press down the fixed-reed to take out the brake pads.

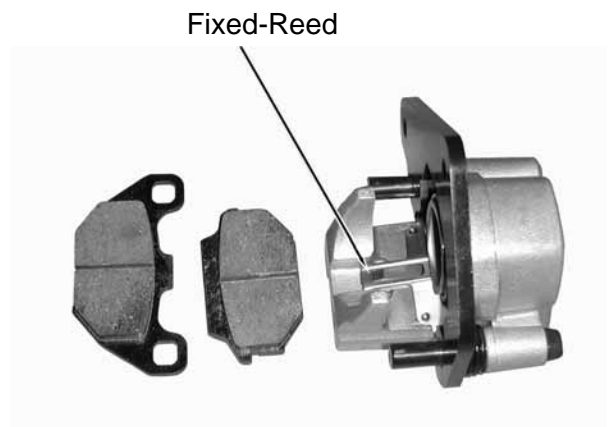

13. STEERING HANDLEBAR/FRONT WHEEL/FRONT BRAKE/FRONT SHOCK ABSORBER/FRONT FORK

SUPER8 50 2T

Install the brake pads in the reverse order of removal.

Tighten the brake pad pin bolt.

Torque: 1.5~2.0kg-m

* Keep grease or oil off the brake pads to avoid brake failure.

Fixed-Reed

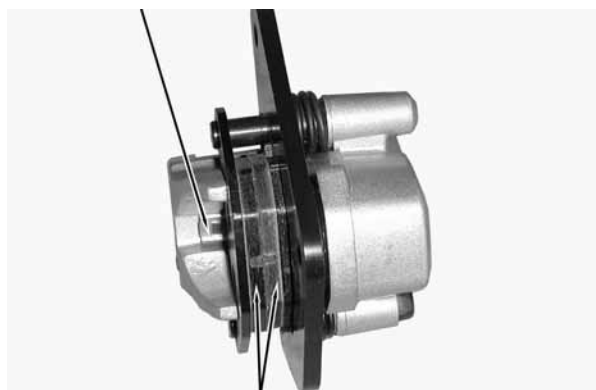

Brake Pads

BRAKE DISK

Measure the brake disk thickness.

Service Limit: 3.0mm

Measure the brake disk runout.

Service Limit: 0.3mm

BRAKE MASTER CYLINDER

REMOVAL

First drain the brake fluid from the hydraulic brake system.

- *
 - When servicing the brake system, use shop towels to cover rubber and plastic parts and coated surfaces to avoid being contaminated by brake fluid.
 - When removing the brake fluid tube bolt, be sure to plug the tube end to avoid brake fluid leakage.

DISASSEMBLY

Remove the piston rubber cover and snap ring from the brake master cylinder.



Master Cylinder

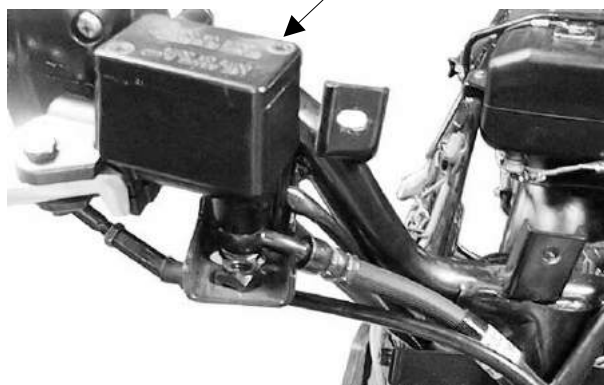

Snap Ring

13. STEERING HANDLEBAR/FRONT WHEEL/FRONT BRAKE/FRONT SHOCK ABSORBER/FRONT FORK

SUPER8 50 2T

INSPECTION

Measure the brake master cylinder I.D.
Inspect the master cylinder for scratches or cracks.

Service Limit: 12.75mm

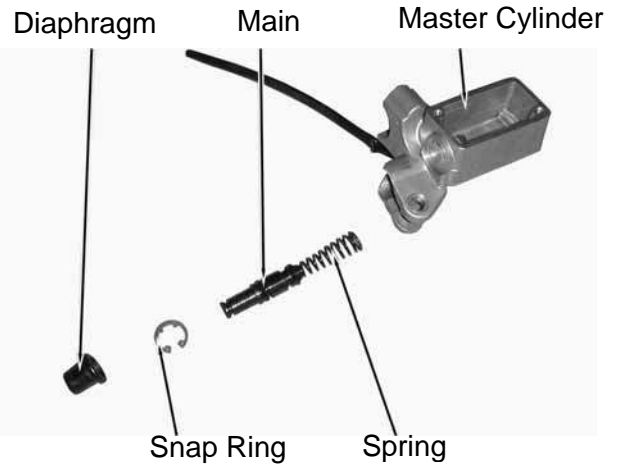

Measure the brake master cylinder piston O.D.

Service Limit: 12.75mm

Before assembly, inspect the 1st and 2nd rubber cups for wear or damage.



ASSEMBLY

Before assembly, apply brake fluid to all removed parts.
Install the spring together with the 1st rubber cup.

- * During assembly, the main piston and spring must be installed as a unit without exchange.
- * When assembling the piston, soak the cups in brake fluid for a while.
- * Install the cups with the cup lips facing the correct direction.

Install the main piston, spring and snap ring.
Install the diaphragm.
Install the brake lever.

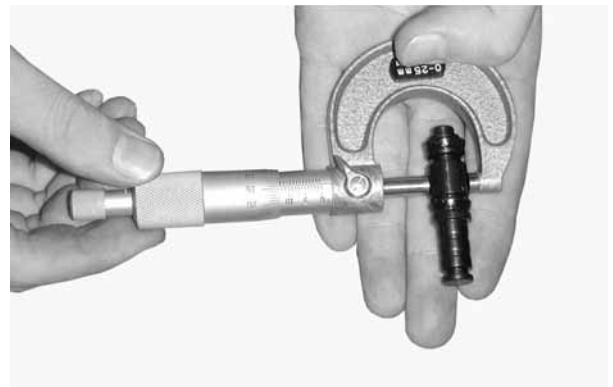

13. STEERING HANDLEBAR/FRONT WHEEL/FRONT BRAKE/FRONT SHOCK ABSORBER/FRONT FORK

SUPER8 50 2T

Place the brake master cylinder on the handlebar and install the holder with the "up" mark facing up. Also align the punch mark with the holder joint seam.

First tighten the upper bolt and then tighten the lower bolt.

Torque: 1.0~1.4kg-m

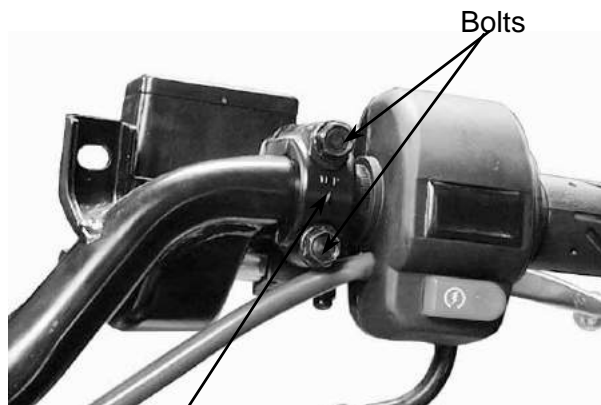

"Up" Mark

Install the brake fluid tube with the attaching bolt and two sealing washers. Install the handlebar covers. Connect the front and rear stop switch wire connectors. Fill the brake reservoir with recommended brake fluid to the upper limit and bleed air according to the method stated in page 12-8.

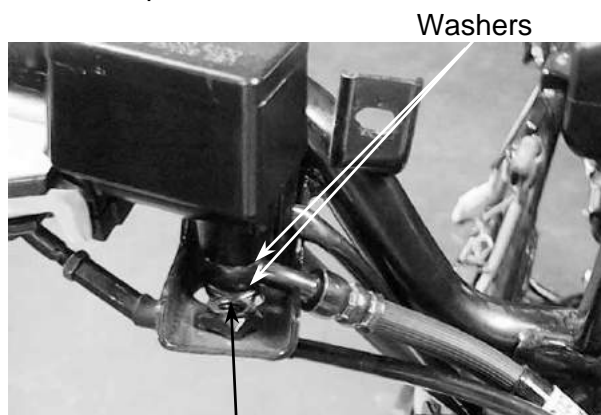

Fluid Tube Bolt

BRAKE CALIPER (FRONT)

REMOVAL

Remove the brake caliper and brake pad springs. (⇒12-9)
Place a clean container under the brake caliper and disconnect the brake fluid pipe from the caliper.

* Do not spill brake fluid on any coated surfaces.



Bolt

DISASSEMBLY

Remove the brake caliper seat from the brake caliper.

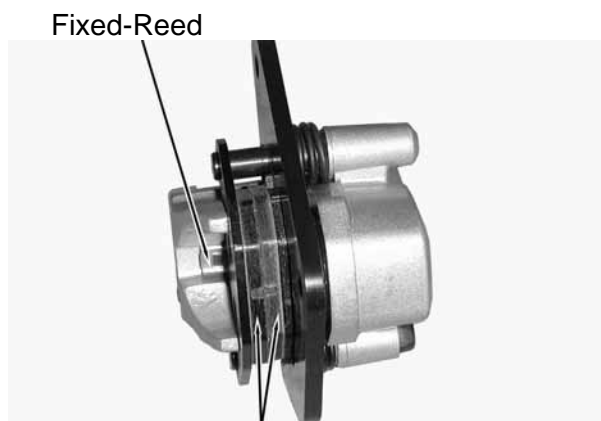

Brake Pads

13. STEERING HANDLEBAR/FRONT WHEEL/FRONT BRAKE/FRONT SHOCK ABSORBER/FRONT FORK SUPER8 50 2T

Remove the pistons from the brake caliper. If necessary, use compressed air to squeeze out the pistons through the brake fluid inlet opening and place a shop towel under the caliper to avoid contamination caused by the removed pistons. Check each piston cylinder for scratches or wear and replace if necessary.

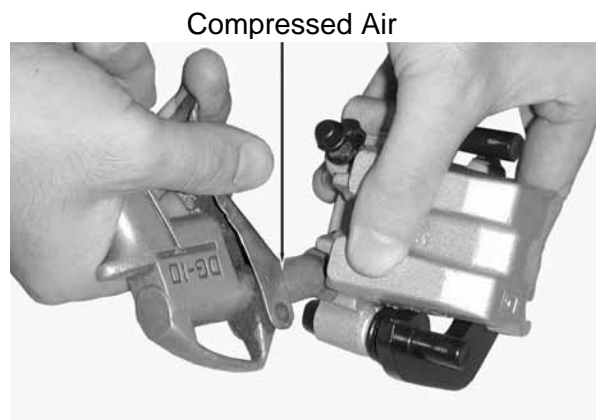

Push the piston oil seals outward to remove them. Clean each oil seal groove with brake fluid.

* Be careful not to damage the piston surface.



Check each piston for scratches or wear. Measure each piston O.D. with a micrometer gauge.

Service Limit: 33.90mm



Check each caliper cylinder for scratches or wear and measure the cylinder bore.

Service Limit: 33.45mm



13. STEERING HANDLEBAR/FRONT WHEEL/FRONT BRAKE/FRONT SHOCK ABSORBER/FRONT FORK

SUPER8 50 2T

ASSEMBLY

Clean all removed parts.
Apply silicon grease to the pistons and oil seals. Lubricate the brake caliper cylinder inside wall with brake fluid.
Install the brake caliper piston with grooved side facing out.

* Install the piston with its outer end protruding 3~5mm beyond the brake caliper cylinder.



Fixed-Reed

Wipe off excessive brake fluid with a clean shop towel. Apply silicon grease to the brake caliper seat pin and caliper inside. Install the brake caliper seat.

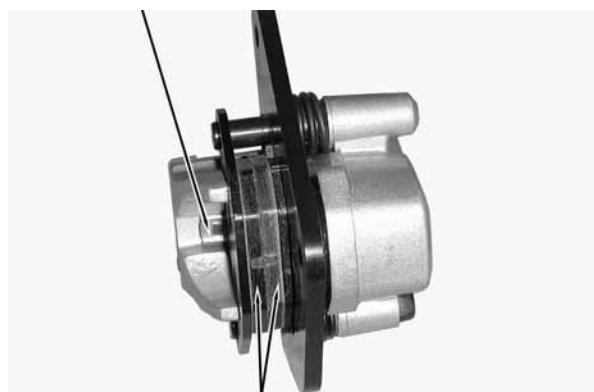

Brake Pads

INSTALLATION

Install the brake caliper and tighten the two bolts.

Torque: 2.9~3.5kg-m

Connect the brake fluid tube to the brake caliper and tighten the fluid tube bolt.

Torque: 3.0~4.0kg-m

Fill the brake reservoir with recommended brake fluid and bleed air from the brake system.



Caliper Bolts

FRONT SHOCK ABSORBER

REMOVAL

Remove the front cover. (⇒2)
Remove the front wheel.
Remove the front shock absorber upper mount bolts.
Loosen the lower mount bolts to remove the front shock absorbers.

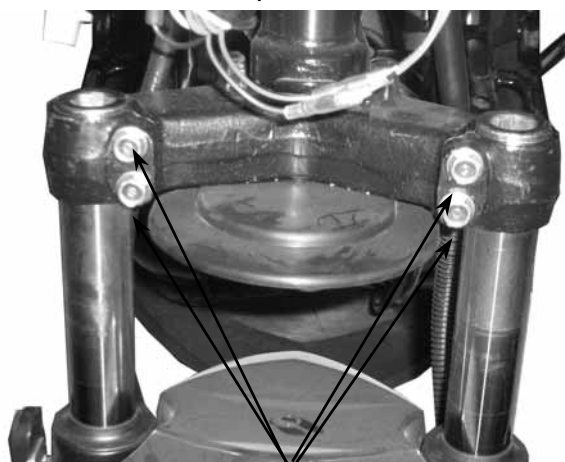

Mount Bolt

13. STEERING HANDLEBAR/Front WHEEL/Front BRAKE/Front SHOCK ABSORBER/Front FORK

SUPER8 50 2T

INSPECTION

Inspect the following items and replace if necessary.

- Front shock absorber tube bending or damage.
- Weak front shock absorber spring.
- Damper and damper rod bending.
- Oil seal damage or wear.

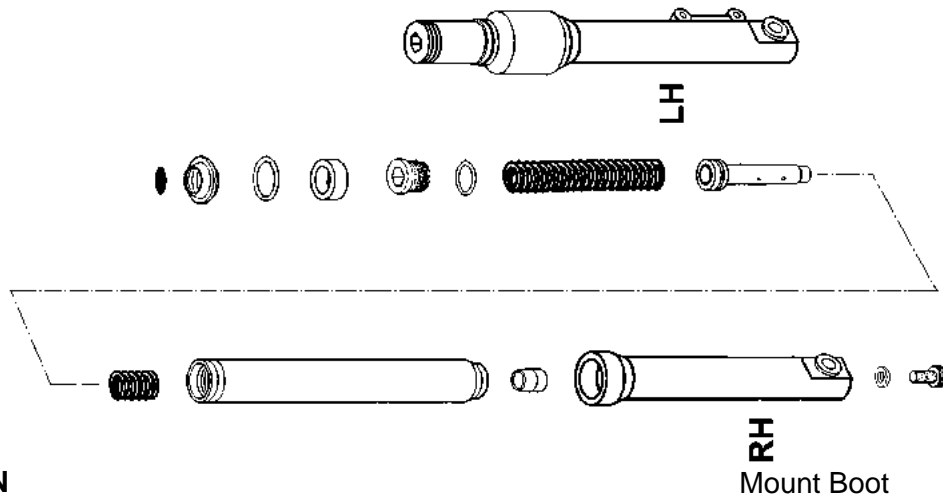

INSTALLATION

Install the front shock absorbers onto the steering stem.
 Install and tighten the front shock absorber upper mount bolts.
 Tighten the lower mount bolts.

* Align the upper mount bolt hole with the groove on the front fork.
 Front shock absorbers are installed at the same altitude.

Install the front wheel.

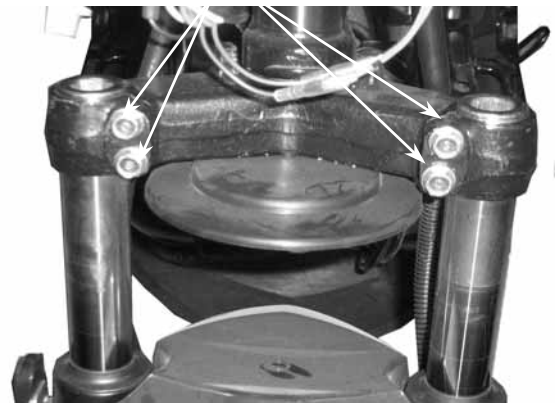

Brake Master Cylinder

STEERING HANDLEBAR

REMOVAL

Remove the handlebar covers. (⇒2)
 Remove the rear brake lever holder bolt to remove the holder.
 Remove the front brake master cylinder holder bolts to remove the brake master cylinder.

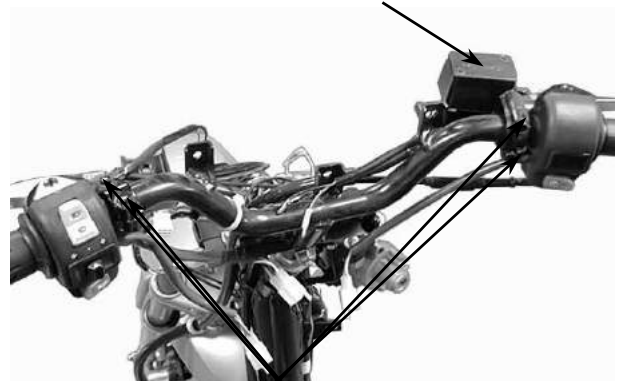

Bolts

13. STEERING HANDLEBAR/Front WHEEL/Front BRAKE/Front SHOCK ABSORBER/Front FORK SUPER8 50 2T

Remove the throttle seat screw.

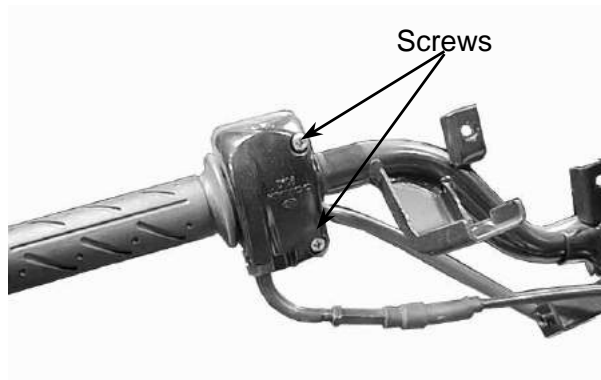

Remove the throttle seat from the handlebar and disconnect the throttle cable from the throttle pipe.
Remove the throttle pipe from the handlebar.



Remove the steering stem lock bolt, collar, nut and the handlebar.



Nut

STEERING STEM

REMOVAL

Remove the steering stem lock nut.

Special

Steering Stem Lock Nut Wrench

Lock Nut wrench



Steering Stem Lock Nut Wrench

13. STEERING HANDLEBAR/FRONT WHEEL/FRONT BRAKE/FRONT SHOCK ABSORBER/FRONT FORK

SUPER8 50 2T

Remove the top cone race.

*

- Be careful not to lose the steel balls (20 on top race and 15 on bottom race).
- Clean the openings of frame covers with clean shop towels.

Remove the front fork.

Top Cone Race

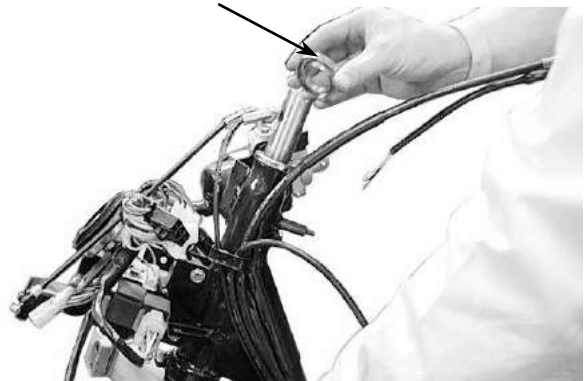

BOTTOM CONE RACE REPLACEMENT

Remove the bottom cone race using a chisel.

*

- Be careful not to damage the steering stem and front fork.

Drive a new bottom cone race into place with a proper driver.



Bottom Cone Race

Ball Race Remover

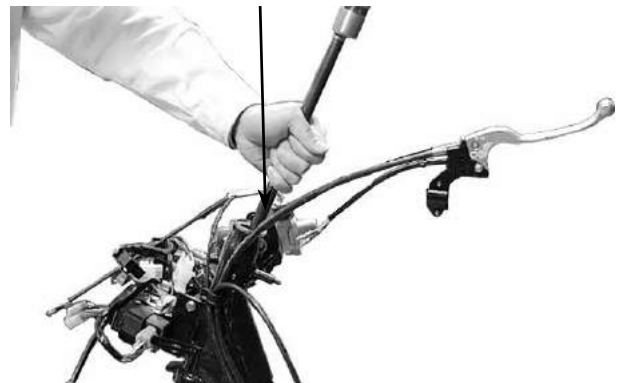

BALL RACE REPLACEMENT

Drive out the top and bottom ball races.

Drive new top and bottom ball races into the steering head using the outer driver.

Special

Outer Driver

Outer Driver

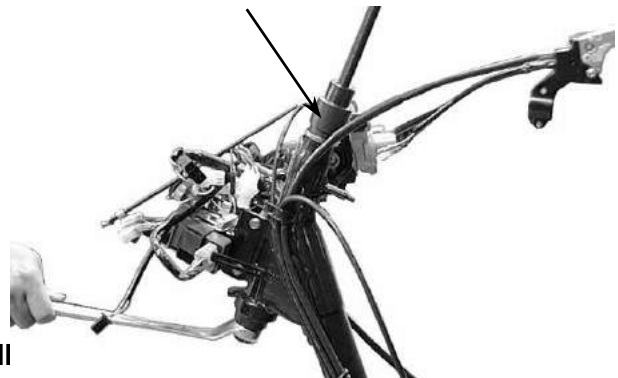

Install the top and bottom steel balls.

13. STEERING HANDLEBAR/FRONT WHEEL/FRONT BRAKE/FRONT SHOCK ABSORBER/FRONT FORK SUPER8 50 2T

Apply grease to the top and bottom ball races and install 20 steel balls on the top ball race and 15 steel balls on the bottom ball race.

Top Steel Ball



Apply grease to the ball races and install the front fork.
Apply grease to the top cone race and install it.
Tighten the top cone race and then turn the steering stem right and left several times to make steel balls contact each other closely.

* Check that the steering stem rotates freely without vertical play.



Top Cone Race

Install the steering stem lock nut and tighten it while holding the top cone race.

Torque: 7.0~8.0kg-m

Install the front wheel. (⇒12-15)

Top Cone Race Lock Nut Wrench



Steering Stem Lock Nut Wrench

HANDLEBAR INSTALLATION

Install the handlebar onto the steering stem tube and then install and tighten the bolt.

Torque: 4.5kg-m

Install the front wheel. (⇒12-6)

Install the brake levers. (⇒12-15)

Install the handlebar covers.



Nut

REAR WHEEL/REAR BRAKE/REAR SHOCK ABSORBER

SERVICE INFORMATION 14-2
TROUBLESHOOTING 14-2
REAR WHEEL 14-3
REAR BRAKE 14-4
REAR SHOCK ABSORBER 14-6

14. REAR WHEEL/REAR BRAKE/REAR SHOCK ABSORBER

SUPER8 50 2T

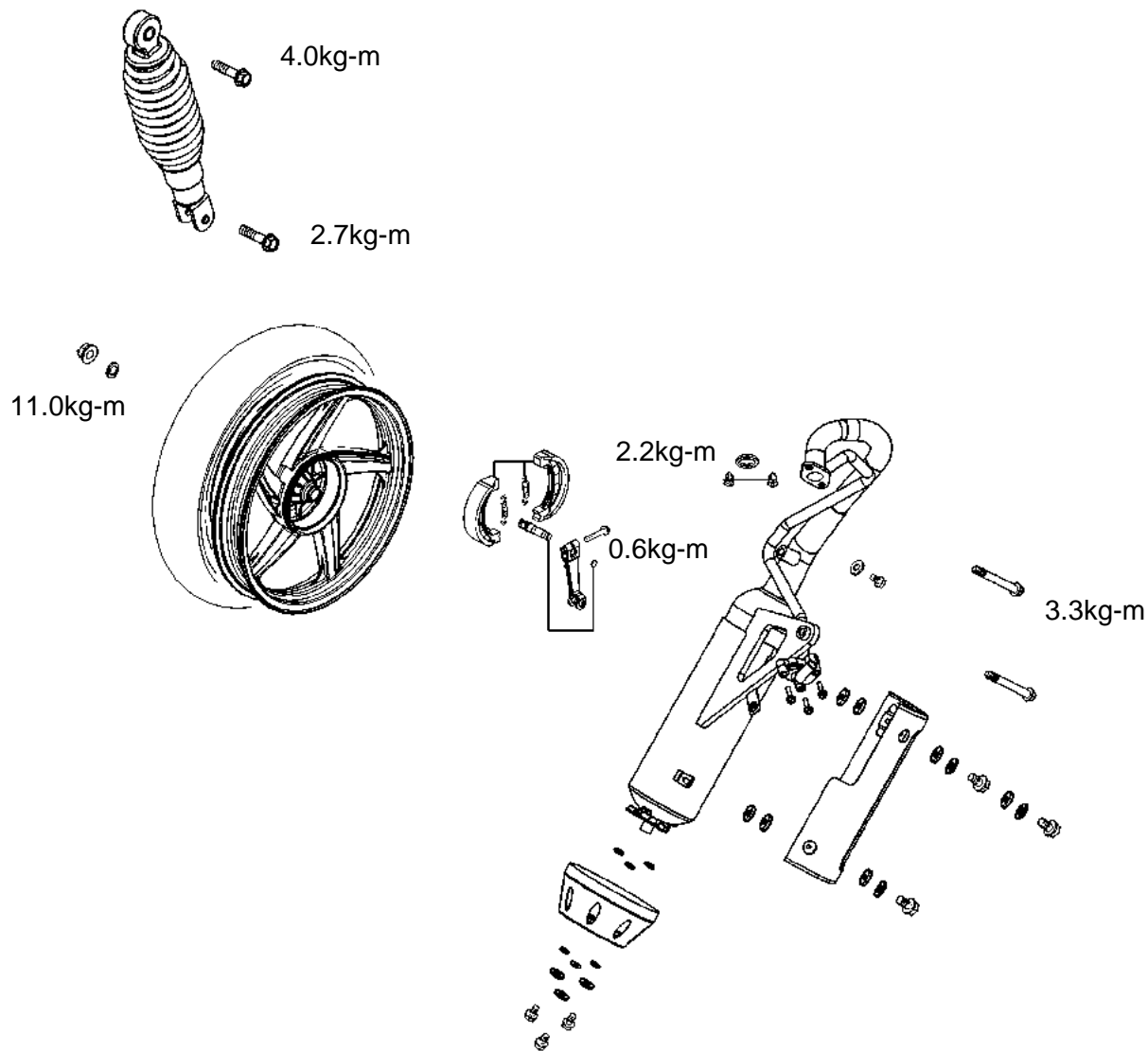

14. REAR WHEEL/REAR BRAKE/REAR SHOCK ABSORBER

SUPER8 50 2T

SERVICE INFORMATION

SPECIFICATIONS

Item	Standard (mm)	Service Limit (mm)
Rear wheel rim runout		2.0
Rear brake drum I.D.	110	111
Rear brake lining thickness	4.0	2.0
Rear shock absorber spring free length	235.7	218.7

TORQUE VALUES

Rear axle nut 11.0~13.0kg-m
Rear shock absorber upper mount bolt 3.5~4.5kg-m
Rear shock absorber lower mount bolt 2.4~3.0kg-m

SPECIAL TOOL

Rear shock absorber remover
Rear shock absorber compressor

TROUBLESHOOTING

Rear wheel wobbling

- Bent rim
- Faulty tire
- Axle not tightened properly

Soft rear shock absorber

- Weak shock absorber spring

Poor brake performance

- Brake not adjusted properly
- Contaminated brake linings
- Worn brake linings
- Worn brake shoes at cam contacting area
- Worn brake cam
- Improper engagement between brake arm and wear indicator plate

14. REAR WHEEL/REAR BRAKE/REAR SHOCK ABSORBER

SUPER8 50 2T

REAR WHEEL

REMOVAL

Remove the two exhaust muffler joint lock nuts.
Remove the two exhaust muffler lock bolts.
Remove the exhaust muffler.
Remove the rear axle nut to remove the rear wheel.

Rear Axle Nut



INSPECTION

Measure the rear wheel rim runout.

Service Limits:

Radial : 2.0mm replace if over

Axial : 2.0mm replace if over

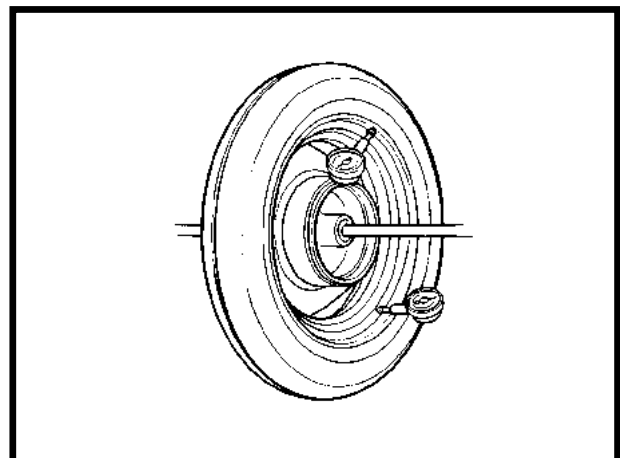

INSTALLATION

Install the rear wheel and apply SAE30# engine oil to the axle threads. Then, tighten the rear axle nut.

Torque values:

Rear axle nut: 11.0~13.0kg-m

Rear Axle Nut



14. REAR WHEEL/REAR BRAKE/REAR SHOCK ABSORBER

SUPER8 50 2T

REAR BRAKE

Remove the rear wheel. (⇒14-3)
Inspect the rear brake drum.
Measure the rear brake drum I.D.

Service Limit: 95.5mm replace if over



BRAKE LINING INSPECTION

Measure the brake lining thickness.

Service Limit: 2.0mm replace if below

*

Keep oil or grease off the brake linings.

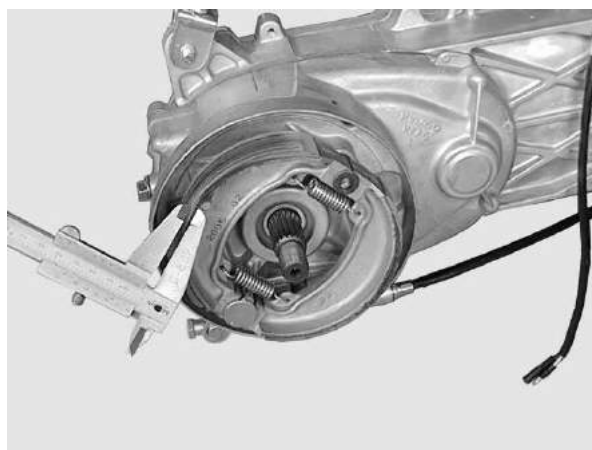

REAR BRAKE DISASSEMBLY

Remove the rear brake adjusting nut and disconnect the rear brake cable.
Remove the rear brake shoes.

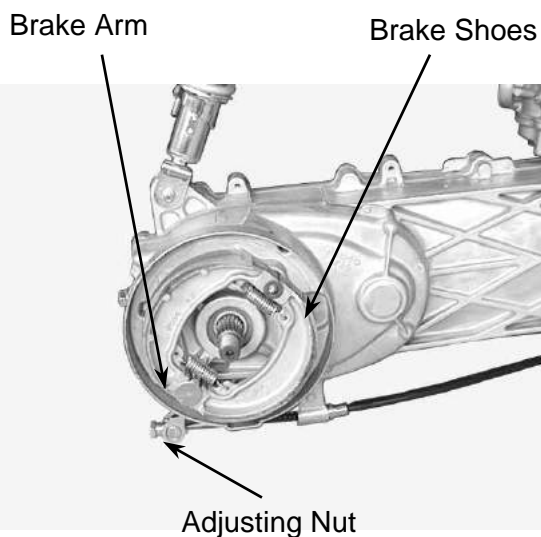

14. REAR WHEEL/REAR BRAKE/REAR SHOCK ABSORBER

SUPER8 50 2T

Remove the brake cam bolt to remove the brake arm, wear indicator plate and felt seal.
Remove the brake arm.

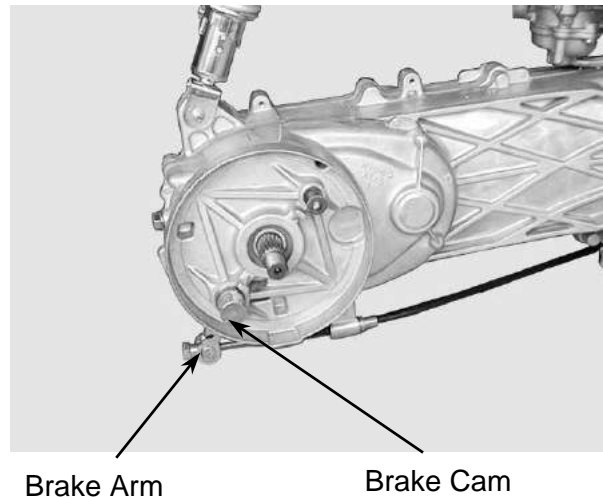

REAR BRAKE ASSEMBLY

Apply grease to the anchor pin and brake shoe moving parts.
Apply grease to the brake cam and install it.

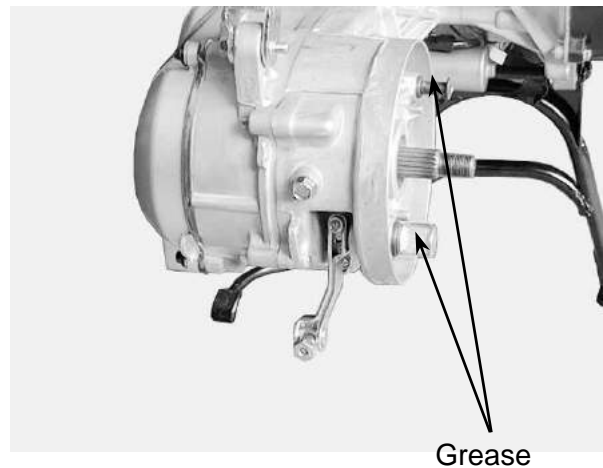

Apply engine oil to the felt seal and install it to the brake cam.
Install the wear indicator plate.

* Align the wide tooth of the wear indicator plate with the wide groove on the brake cam.

Install the brake arm onto the brake cam.

* Align the punch mark on the brake arm with the scribed line on the brake cam.

Install and tighten the brake arm bolt.
Install the brake arm return spring.
Install the brake shoes.

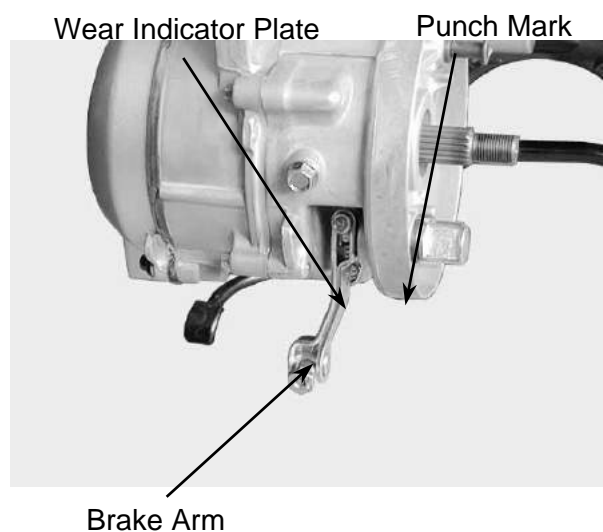

14. REAR WHEEL/REAR BRAKE/REAR SHOCK ABSORBER

SUPER8 50 2T

Install the brake arm pin.
Connect the brake cable and install the adjusting nut.
Install the rear wheel. (⇒14-3)
Adjust the rear brake lever free play. (⇒3-4)

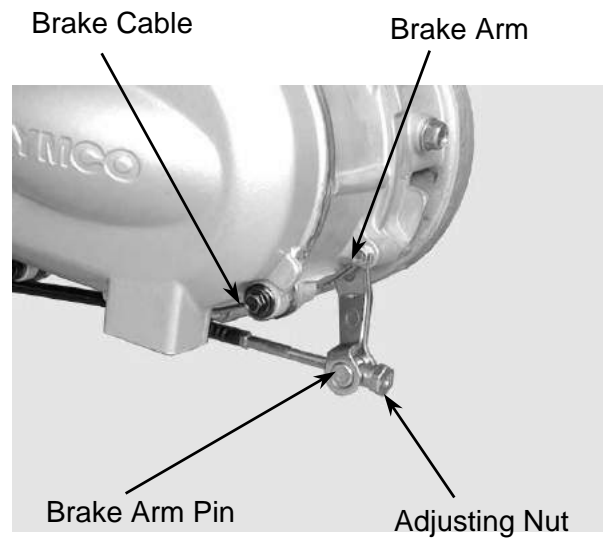

REAR SHOCK ABSORBER

REMOVAL

Remove the front cover. (⇒12-6)
Remove the met-in box. (⇒12-5)
Remove the air cleaner case. (⇒5-2)
Remove the rear shock absorber upper and lower mount bolts to remove the rear shock absorber.

Upper Mount Bolt

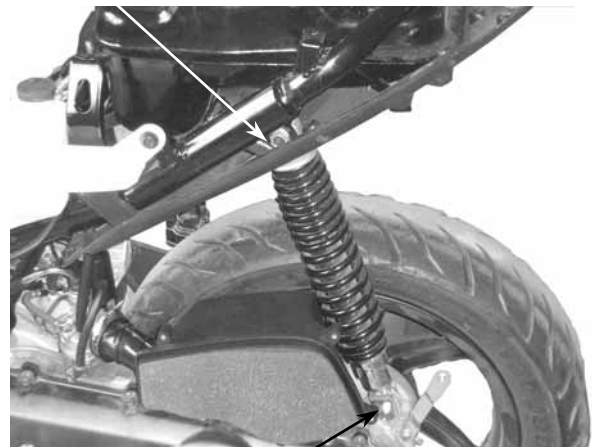

Lower Mount Bolt

INSTALLATION

Install the rear shock absorber.
Install the rear shock absorber upper mount bolt and then install the lower mount bolt.

Torque:

Upper Mount Bolt: 3.5~4.5kg-m

Lower Mount Bolt: 2.4~3.0kg-m

Install the frame body cover. (⇒12-5)

Rear Shock Absorber

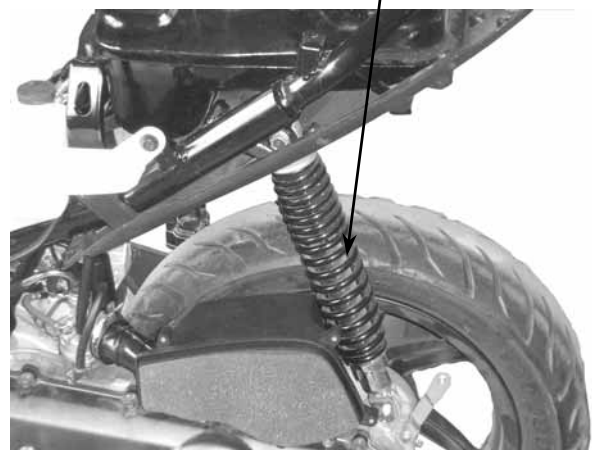

ELECTRICAL EQUIPMENT

SERVICE INFORMATION 15- 1

TROUBLESHOOTING..... 15- 1

CHARGING SYSTEM..... 15- 3

BATTERY 15- 4

IGNITION SYSTEM 15- 7

STARTING SYSTEM..... 15- 11

SERVICE INFORMATION

GENERAL INSTRUCTIONS

- It is not necessary to check the battery electrolyte or fill with distilled water.
- Remove the battery from the motorcycle for charging. Do not remove the electrolyte cap..
- Do not quick charge the battery. Quick charging should only be done in an emergency..
- Charge the battery according to the charging current and time specified on the battery.
- When charging, check the voltage (open voltage) with an electric tester.
- When replacing the battery, do not use a traditional battery.

SPECIFICATIONS

SPECIFICATIONS		SUPER8 50 2T	
Battery	Capacity	12V6AH	
	Voltage	13.0~13.2V	
	Charging current	Standard	0.4A/5H
		Quick	4A/0.5H
Spark plug	(NGK)	BR8HSA	
Spark plug gap		0.6~0.7mm	
Ignition coil resistance	Primary coil	0.2~0.3Ω	
	Secondary coil (with plug cap)	7.0~8.4KΩ	
	Secondary coil (without plug cap)	2.5~3.2KΩ	
Pulser coil resistance (20°C)		80~160Ω	
Ignition timing		13.5°±1°BTDC/2000rpm	

TROUBLESHOOTING

CHARGING SYSTEM

No power

- Dead battery
- Disconnected battery cable
- Fuse burned out
- Faulty ignition switch

Low power

- Weak battery
- Loose battery connection
- Charging system failure
- Faulty regulator/rectifier

Intermittent power

- Loose battery cable connection
- Loose charging system connection
- Loose connection or short circuit in ignition system
- Loose connection or short circuit in lighting system

Charging system failure

- Loose, broken or shorted wire or connector
- Faulty regulator/rectifier
- Faulty A.C. generator

IGNITION SYSTEM

No spark at plug

- Faulty spark plug
- Poorly connected, broken or shorted wire
 - Between A.C. generator and CDI unit
 - Between CDI unit and ignition coil
 - Between CDI unit and ignition switch
 - Between ignition coil and spark plug
- Faulty ignition switch
- Faulty ignition coil
- Faulty CDI unit
- Faulty A.C. generator

Engine starts but turns poorly

- Ignition primary circuit
 - Faulty ignition coil
 - Poorly connected wire or connector
- Ignition secondary circuit
 - Faulty ignition coil
 - Faulty spark plug
 - Poorly insulated plug cap
- Improper ignition timing
 - Battery voltage too low (6V max.)
 - Faulty CDI unit

STARTING SYSTEM

Starter motor won't turn

- Fuse burned out
- Weak battery
- Faulty ignition switch
- Faulty starter switch
- Faulty front or rear stop switch
- Faulty starter relay
- Poorly connected, broken or shorted wire
- Faulty starter motor

Lack of power

- Weak battery
- Loose wire or connection
- Foreign matter stuck in starter motor or pinion

Starter motor rotates but engine does not start

- Faulty starter pinion
- Starter motor rotates reversely
- Faulty starter clutch
- Weak battery

CHARGING SYSTEM

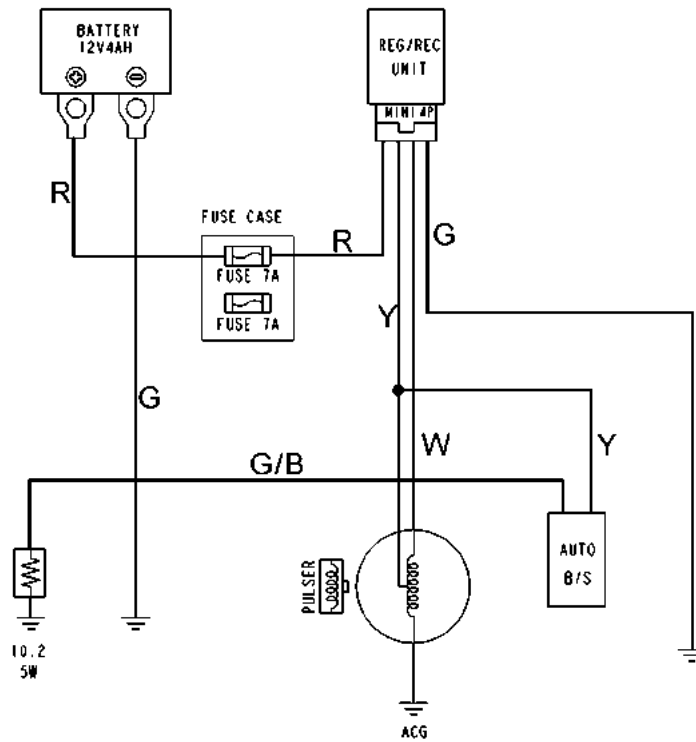
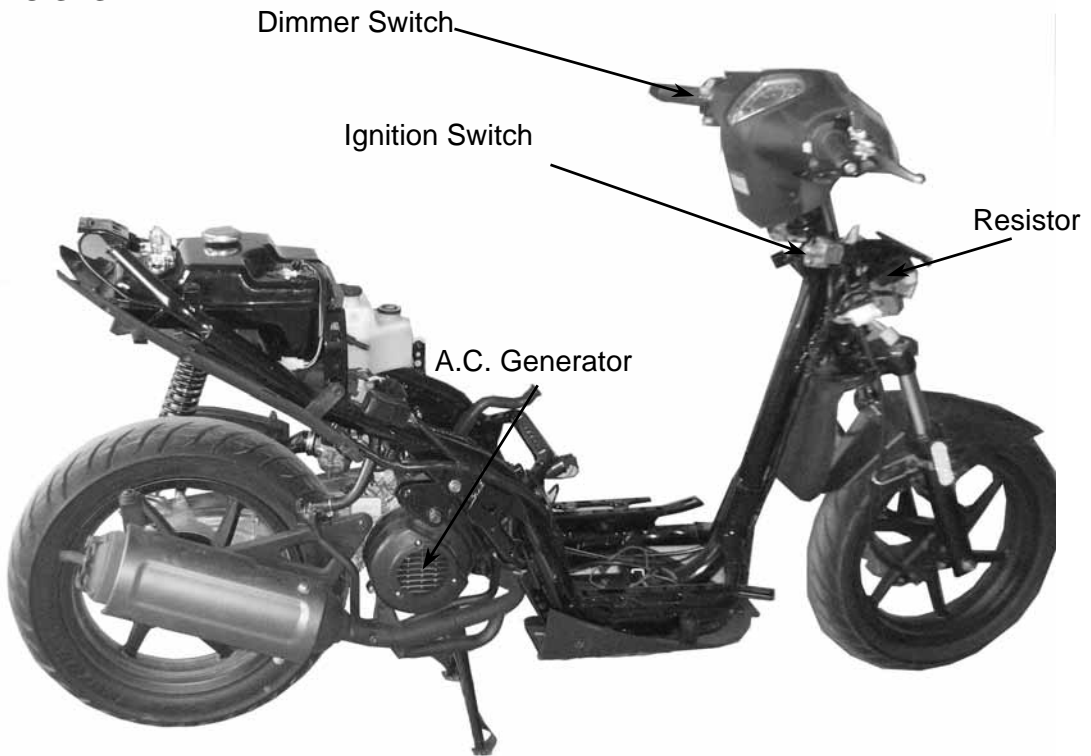

BATTERY

BATTERY REMOVAL

Remove the battery cover.
Disconnect the battery cables .

- * First disconnect the battery negative (-) cable and then the positive (+) cable.

Remove the battery.
The installation sequence is the reverse of removal.

BATTERY CHARGING (OPEN CIRCUIT VOLTAGE) INSPECTION

Remove the battery cover and disconnect the battery cables.

Measure the voltage between the battery terminals.

Fully charged : 13.0V~13.2V

Undercharged : 12.3V max.

- * Battery charging inspection must be performed with an electric tester.

CHARGING METHOD

Connect the charger positive (+) cable to the battery positive (+) cable.

Connect the charger negative (-) cable to the battery negative (-) cable.

- *
 - Keep flames and sparks away from a charging battery.
 - Turn power ON/OFF at the charger, not at the battery terminals to prevent sparks near the battery.
 - Charge the battery according to the current specified on the battery surface.

Charging current: Standard: 0.4A

Quick : 4A

Charging time : Standard: 5 hours

Quick : 0.5 HOUR

After charging: Open circuit voltage: 12.8V min.

- *
 - Quick charging should only be done in an emergency.
 - During quick charging, the battery temperature should not exceed 45°C .
 - Measure the voltage 30 minutes after the battery is charged.

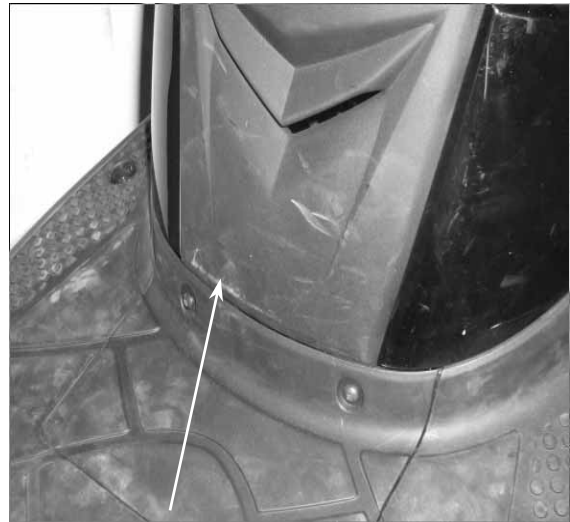

Battery Cover

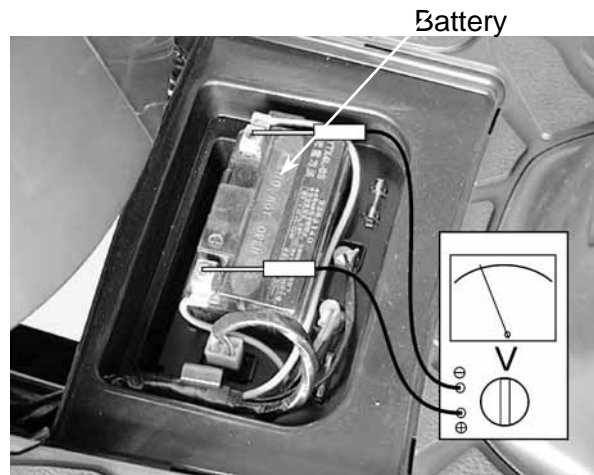

Battery

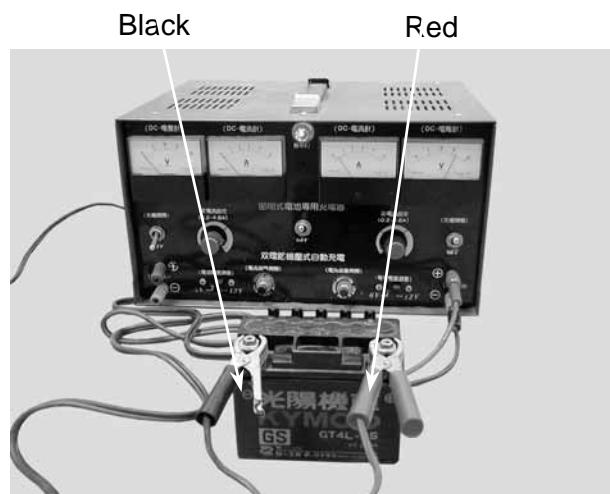

Black

Red

PERFORMANCE TEST

Warm up the engine.
Remove the floor mat and front tool box cover.

* Use a fully charged battery to check the charging system output.

Stop the engine and open the fuse box. Disconnect the wire lead from the fuse terminal. Connect an ammeter between the wire lead and fuse terminal as shown. Connect the battery positive (+) terminal to the voltmeter positive (+) probe and battery negative (-) terminal to the voltmeter negative (-) probe. Start the engine, gradually increase engine speed to test the output:

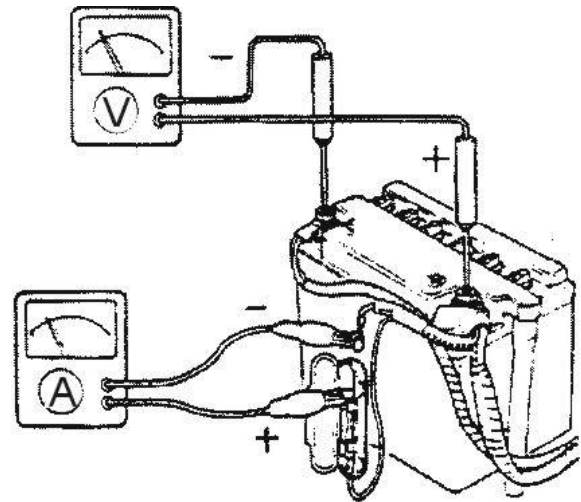

Position \ RPM	Day	Night
2500	1.3A min.	1.0A min.
6000	2.0A min.	2.0A min.

Charging Limit Voltage: $14.5 \pm 0.5V/8000rpm$
If the limit voltage is not within the specified range, check the regulator/ rectifier.

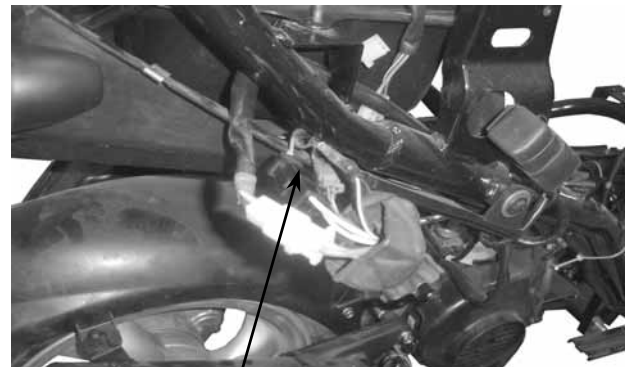

A.C. Generator Connector

A.C. GENERATOR (CHARGING COIL) INSPECTION

* Inspect with the engine installed.

Remove the met-in box. (\Rightarrow 12-4)
Disconnect the A.C. generator connector.
Measure the resistances between the charging coil terminals (pink) and lighting coil terminals (yellow).

Resistances:

Charging coil	pink	$0.4 \sim 2\Omega$
Lighting coil	yellow	$0.3 \sim 2\Omega$

Refer to 7-3 for A.C. generator removal.



RESISTOR INSPECTION

Remove the frame front cover. (⇒12-3)
 Measure the resistance between the resistor with ground.

Resistances:

Resistor: 9.9~12.0Ω

* Faulty resistor is the cause of faulty operation of the auto bystarter.



Resistor

REGULATOR/RECTIFIER INSPECTION

Remove the front cover. (⇒12-3)
 Disconnect the regulator/rectifier wire coupler and remove the bolt to remove the regulator/rectifier.

Measure the resistances between the terminals.
 Replace the regulator/rectifier if the readings are not within the specifications in the table below.

*
 • Due to the semiconductor in circuit, it is necessary to use a specified tester for accurate testing. Use of an improper tester in an improper range may give false readings.
 • Use a Sanwa Electric Tester (07208-0020000) or Kowa Electric Tester (TH-5H). The proper range for testing is listed below.



Regulator/Rectifier

Coupler

Model	Brand	Range
SP-10D	Sanwa	KΩ
TH-5H	Kowa	100Ω

(+)Probe \ (-)Probe	Peach	Yellow	Red	Green	Black
Peach		∞	4-7K	∞	∞
Yellow	∞		4-7K	∞	∞
Red	∞	∞		∞	∞
Green	4-6K	4-6K	13-17K		1-2K
Black	4-7K	4-7K	13-17K	1-2K	

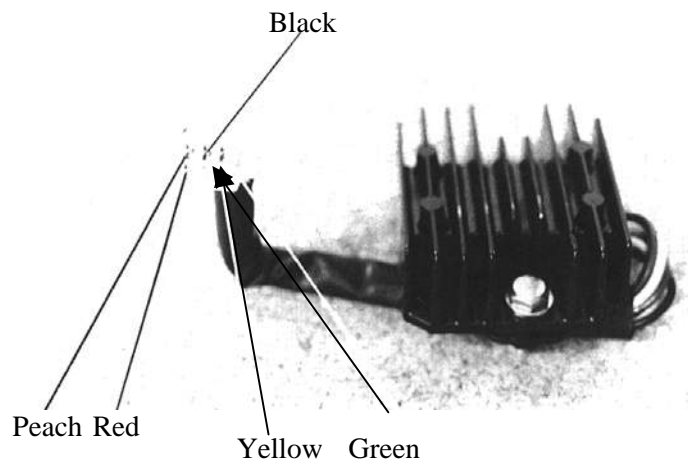

IGNITION COIL INSPECTION

Continuity Test

* This test is to inspect the continuity of ignition coil.

Remove the met-in box. (⇒12-4)
Measure the resistance between the ignition coil primary coil terminals.

Resistance (20°C): 0.153~0.187Ω

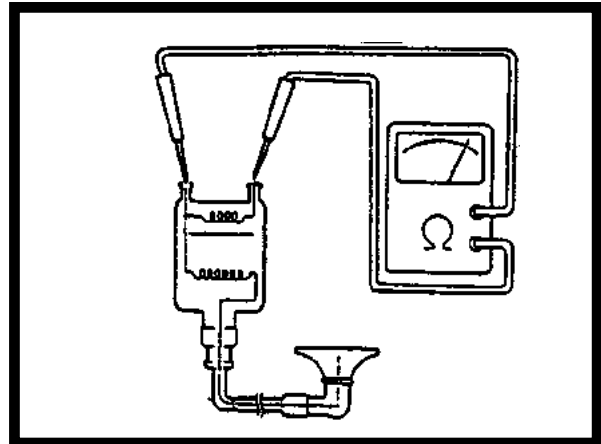

Measure the secondary coil resistance between the spark plug cap and the primary coil terminal as Figure A shown.

Resistance (20°C) (with plug cap):
10~14KΩ

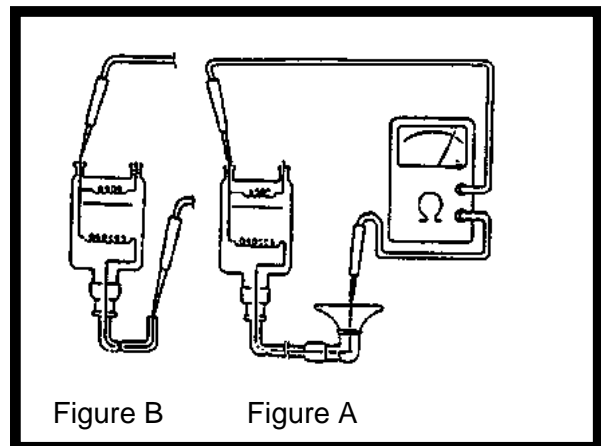

Measure the secondary coil resistance between the ignition coil terminal and the primary coil terminal as Figure B shown.

Resistance (20°C) (without plug cap):
7~9KΩ



Ignition Coil

Performance Test

Remove the ignition coil.



Ignition Coil

Inspect the ignition coil with an ignition coil tester.

* Follow the ignition coil tester manufacturer's instructions.

1. Turn the changeover switch to 12V and connect the ignition coil to the tester.
2. Turn the power switch ON and check the spark from the watch window.
 - Good : Normal and continuous spark
 - Faulty: Weak or intermittent spark

* The test is performed at both conditions that the ignition coil is cold and hot.

A.C. GENERATOR

Exciter Coil/Pulser Coil Inspection

* This test is performed with the stator installed in the engine.

Remove the met-in box. (⇒12-4)
Disconnect the A.C. generator wire connector.
Measure the pulser coil resistance between the blue/yellow wire and ground.

Resistance (20°C): 100~150Ω



CDI UNIT INSPECTION

Remove the front cover.
 Disconnect the CDI coupler and remove the CDI unit.



CDI Unit

CDI CIRCUIT INSPECTION

Measure the resistance between the terminals.
 Replace the CDI unit if the readings are not within the specifications in the table below.

- * —————
- Due to the semiconductor in circuit, it is necessary to use a specified tester for accurate testing. Use of an improper tester in an improper range may give false readings.
 - Use a Sanwa Electric Tester or Kowa Electric Tester (TH-5H).
 - In this table, "Needle swings then returns" indicates that there is a charging current applied to a condenser. The needle will then remain at "∞" unless the condenser is discharged.

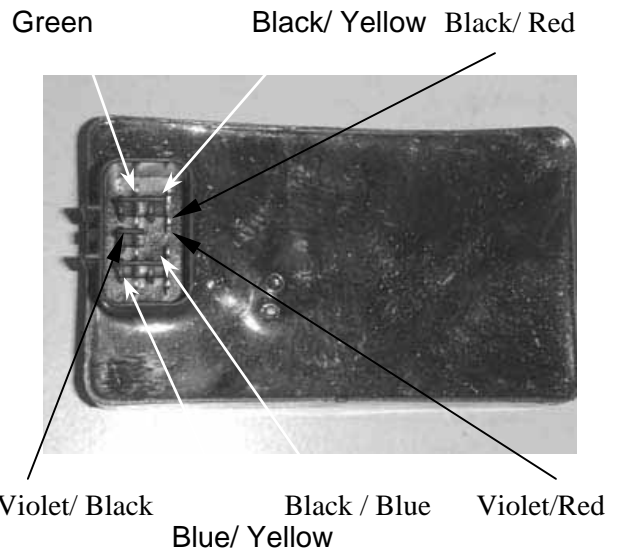

Use the x KΩ range for the Sanwa Tester.
 Use the x 100Ω range for the Kowa Tester.

Unit:

Probe⊕ (-)Prob	Black	Blue/ Yellow	Green	Black/ Yellow
Black		4~7MΩ	4~7MΩ	2~3MΩ
Blue/ Yellow	15~20KΩ		600~900Ω	1000~1500KΩ
Green	15~20MΩ	600~900Ω		4~7MΩ
Black/ Yellow	∞	∞	∞	

STARTING SYSTEM

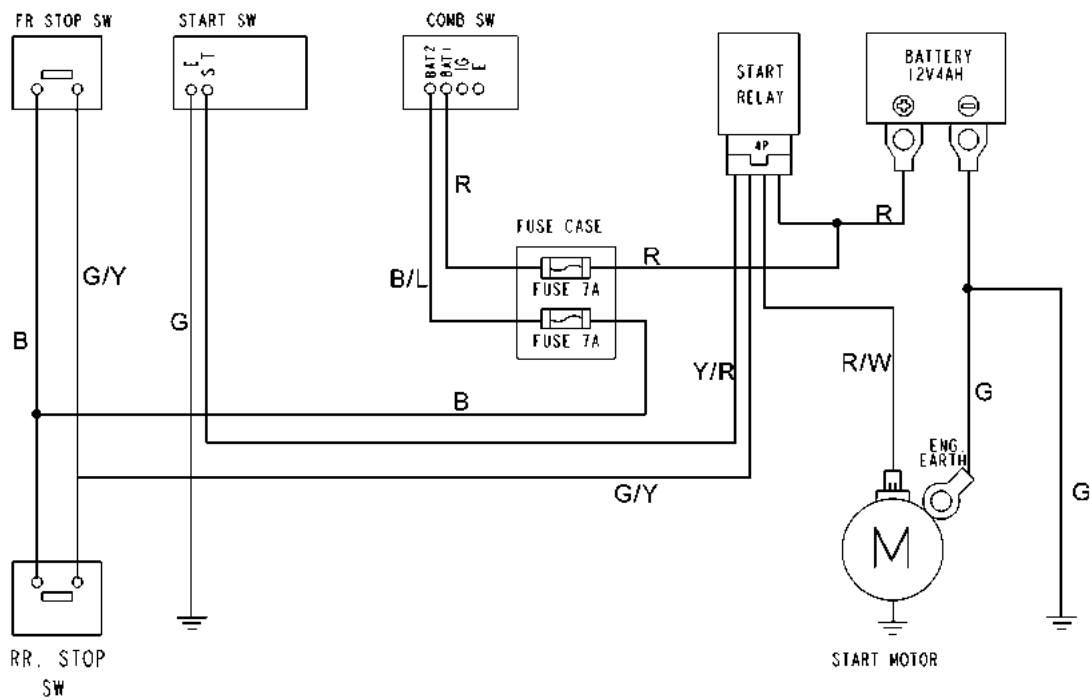
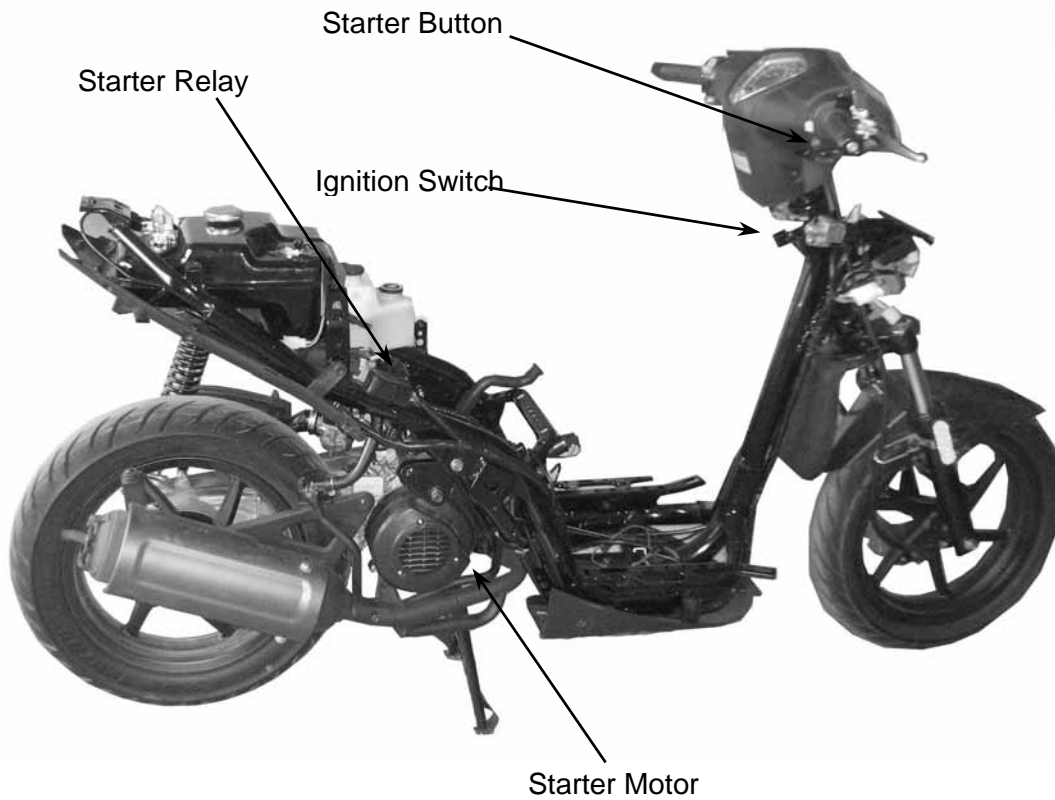

STARTER RELAY INSPECTION

Remove the foot-floor cover.
Disconnect the starter relay coupler and
then remove the starter relay.

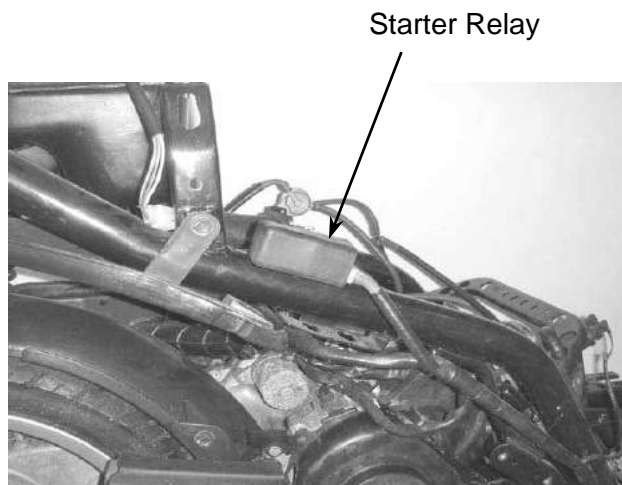

Connect the starter relay (D) terminal to the 12V battery positive (+) terminal and the relay (C) terminal to the battery negative (-) terminal. Check for continuity between the starter relay (A) and (B) terminals. The relay is normal if there is continuity.

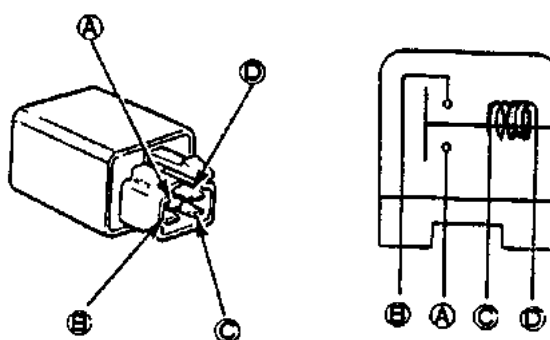

STARTER MOTOR REMOVAL

Disconnect the starter motor cable.
Remove the two bolts attaching the starter motor and remove the starter motor.
The installation sequence is the reverse of removal.

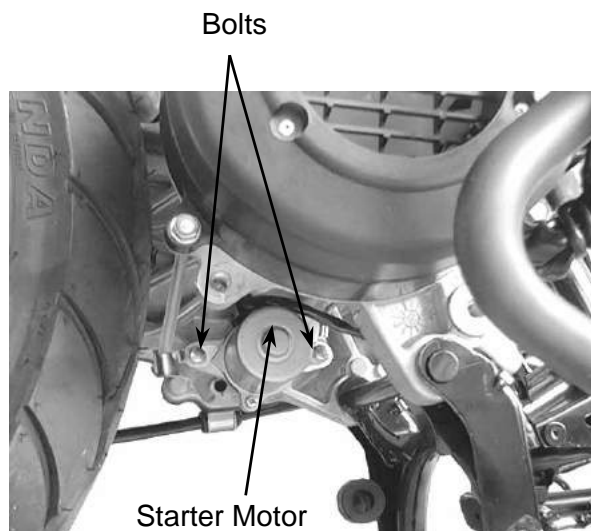

STARTER MOTOR INSPECTION

Connect a battery across the starter motor and check for its operation.

*

1. Do not turn the starter motor for a long time.
2. This inspection should be done with a fully charged battery.

Starter Motor

Battery (+) Terminal

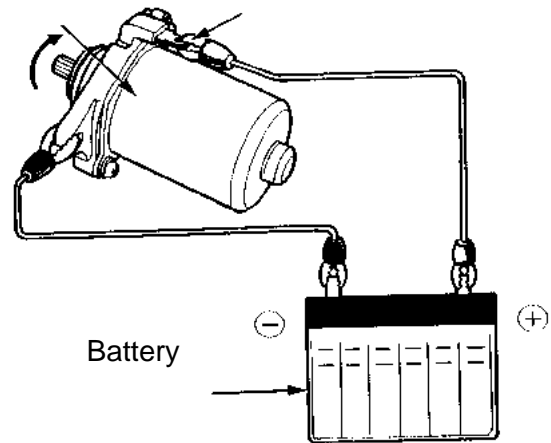

INSTRUMENT/SWITCHES/LIGHTS

SERVICE INFORMATION 16-1

TROUBLESHOOTING..... 16-1

FUEL UNIT 16-2

OIL METER 16-3

SWITCHES..... 16-4

STOP SWITCH INSPECTION/HORN 16-6

FRONT TURN SIGNAL LIGHT REPLACEMENT 16-7

INSTRUMENT/HEADLIGHT..... 16-8

SERVICE INFORMATION

GENERAL INSTRUCTIONS

- Wires should be connected to other wires of the same color. Couplers must be connected to other couplers of the same color.
- All plastic plugs have locking tabs that must be released before disconnecting, and must be aligned when reconnecting.
- After installation of each switch, a continuity check must be performed.

TROUBLESHOOTING

Lights do not come on when ignition switch is "ON"

- Burned bulb
- Faulty switch
- Broken or shorted wire
- Fuse burned out
- Weak battery
- Poorly connected wire
- Faulty winker

Light dims

- Faulty ignition coil
- Wire or switch resistance too high
- Faulty regulator/rectifier

Headlight does not change when dimmer switch is turn to Hi or Lo

- Faulty or burned bulb
- Faulty dimmer switch

Motor oil indicator light does not come on (when motor oil is insufficient)

- Fuse burned out
- Dead battery
- Faulty ignition switch
- Faulty instrument
- Faulty oil meter

Motor oil indicator light winks

- Loose wire connection
- Broken wire
- Faulty oil meter

Fuel gauge pointer does not register correctly

- Disconnected wire or connector
- Broken wire
- Faulty float
- Faulty fuel unit
- Faulty instrument

Fuel gauge pointer fluctuates or swings

- Loose wire connection
- Faulty fuel unit
- Faulty instrument

FUEL UNIT

* No Smoking!

REMOVAL

Remove the seat. (2-4)
 Remove the body cover. (2-5)
 Disconnect the fuel unit wire connectors.

* Do not damage the fuel unit wire.

Remove the fuel unit.

* Be careful not to bend or damage the fuel unit float arm.

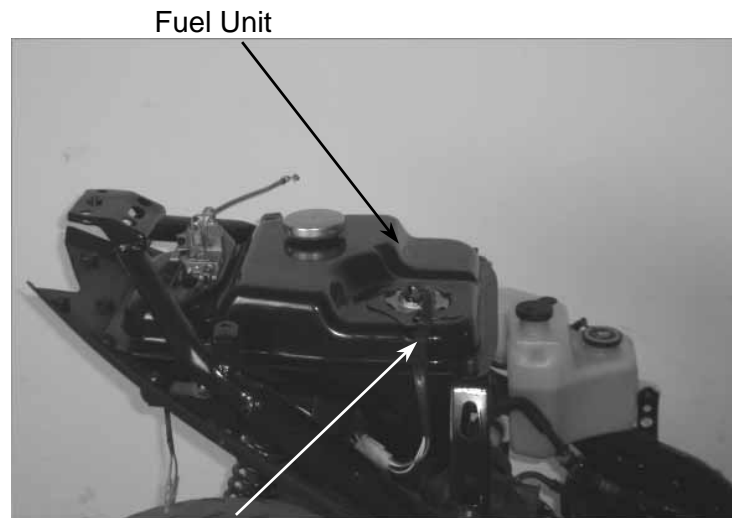

Fuel Unit Wire

INSPECTION

Remove the fuel unit.
 Measure the resistance between the fuel unit wire terminals with the float at upper and lower positions.

RESISTANCES Unit: Ω

Wire Terminals	Upper	Lower
G~Y/W	20~40	560~580



FUEL GAUGE INSPECTION

Connect the fuel unit wire connectors and turn the ignition switch "ON".

* Before performing the following test, operate the turn signals to determine that the battery circuit is normal.

Check the fuel gauge needle for correct indication by moving the fuel unit float up and down.

Float Position	Needle Position
Upper	"F" (Full)
Lower	"E" (Empty)

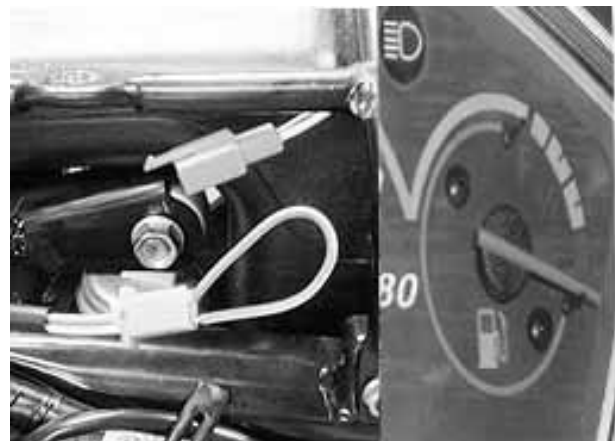

INSTALLATION

The installation sequence is the reverse of removal.

- * • Install the fuel unit at the connect position.

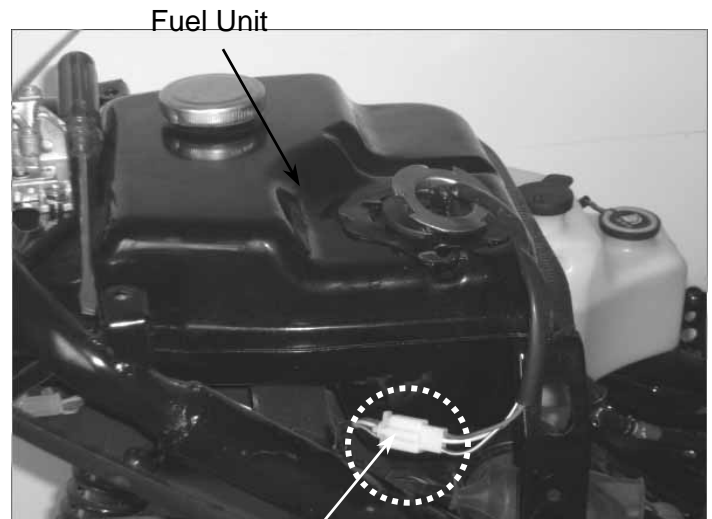

Fuel Unit

Wire Connector

OIL METER

INSPECTION

Remove the met-in box. (⇒12-4)
 Remove the frame body cover. (⇒12-4)
 Disconnect the oil meter wire connectors and remove the oil meter. Keep the oil meter float at the lower position.
 Measure the resistances between the wire terminals as ① and ② shown in the left figure.

Wire Terminals	Resistance
Green/Red(+)-Black(-)	46Ω
Green(-)-Black(+)	∞

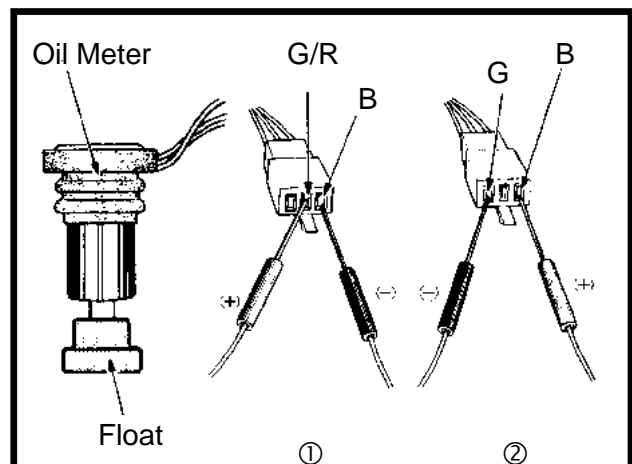

- * Before removing the oil meter, be sure to drain the motor oil and do not allow sparks or flames near the working area.

Oil Meter Operation Inspection

Connect the oil meter wire connectors and turn the ignition switch ON.
 Measure the resistance between the wire terminals with the float at upper position.

Green/Red(+)-Black(-)	About 300Ω
-----------------------	------------

- * Before performing the following test, operate the turn signals to determine that the battery circuit is normal.

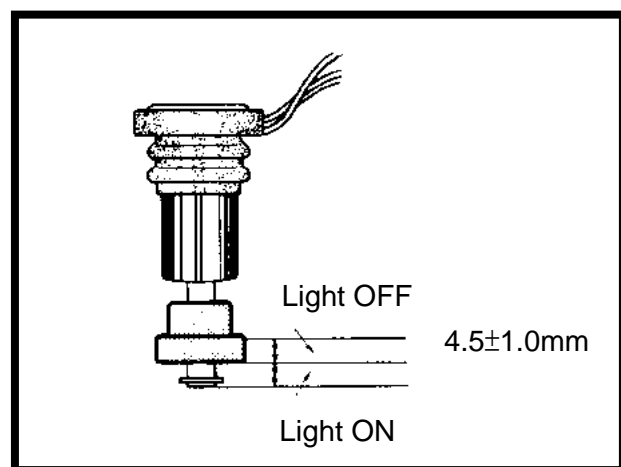

Move the oil meter float up and down to see if the oil indicator light will go out and come on.

* If the oil indicator light does not light, check for burned bulb, loose wire or connector. After correction, check again according to the method mentioned above.

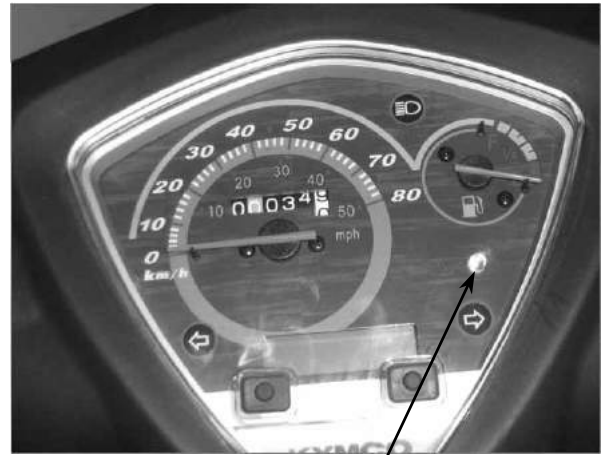

Oil Indicator Light

SWITCHES

IGNITION SWITCH INSPECTION

Remove the front cover. (⇒12-3)
 Disconnect the ignition switch wire couplers and check for continuity between the wire terminals.

Color	Red	Black/White	Green	Black
Symbol	BAT1	IG	E	BAT2
LOCK		○—○	○	
OFF		○—○	○	
ON	○			○



IGNITION SWITCH REPLACEMENT

Remove the front cover. (⇒12-3)
 Disconnect the ignition switch wire couplers.
 Remove the two mounting bolts and remove the ignition switch.
 The installation sequence is the reverse of removal.

Bolts



DIMMER SWITCH INSPECTION

Check for continuity between wire terminals.

Color	W/L	L	We	Y
Symbol	HL	HI	LO	BAT
HI	○	○		
LO	○		○	
PASSING		○		○

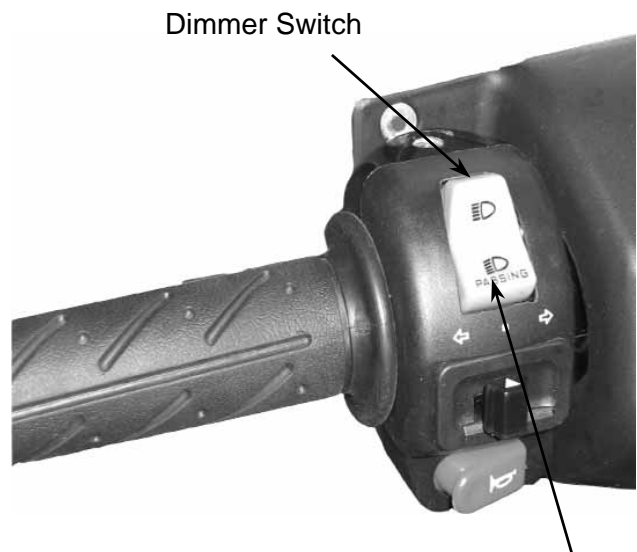

Passing Switch

TURN SIGNAL SWITCH INSPECTION

Check for continuity between the wire terminals.

Color	SB	O	GR
Symbol	R	L	WR
R	○		○
L		○	○



Turn Signal Switch

STARTER SWITCH INSPECTION

Check for continuity between wire terminals.
Push the starter button when measuring.

Color	Y/R	G
Symbol	ST	E
FREE		
PUSH	○ — ○	○ — ○



Starter Switch

HORN SWITCH INSPECTION

Check for continuity between wire terminals.
Push the horn button when measuring.

Color	Light Green	Brown / Blue
Symbol	HO	BAT
FREE		
PUSH	○ — ○	○ — ○



Horn Switch

STOP SWITCH INSPECTION

Remove the handlebar front cover. (⇒12-3)
Disconnect the front and rear stop switch wire couplers.
Check for continuity between the wire terminals when the front/rear brake lever is applied.

Stop Switch Wire



HORN INSPECTION

Remove the frame front cover. (⇒12-3)
Disconnect the horn wire couplers. The horn is normal if it sounds when a 12V battery is connected across the horn wire terminals.

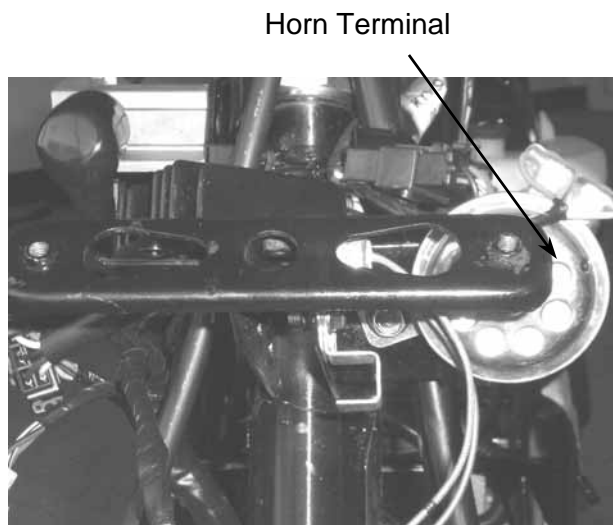

FRONT TURN SIGNAL LIGHT REPLACEMENT

Remove three screws attaching the turn signal light set and remove the light set.

*
Replace with new set of the same specifications.

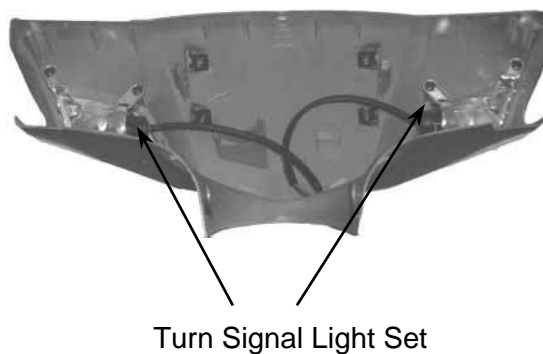

TAILLIGHT/STOPLIGHT/REAR TURN SIGNAL LIGHT BULB REPLACEMENT

Taillight Base Removal:
Remove the rear protective cover.
Remove the seat.
Remove the body cover.
Remove the taillight base.
The installation sequence is the reverse of remove.

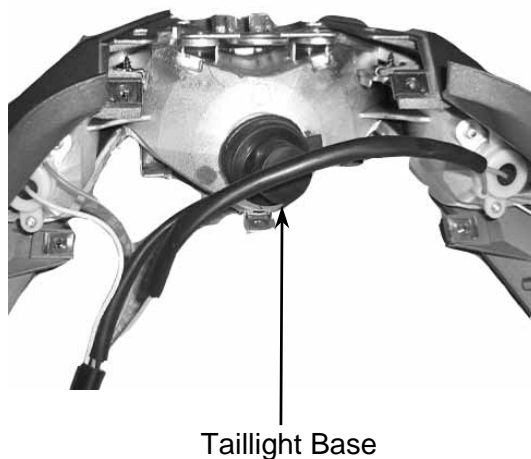

INSTRUMENTS

BULB REPLACEMENT

Remove the handlebar rear cover. (⇒2)
 Remove the bulb socket and replace the bulb.
 The installation sequence is the reverse of removal.

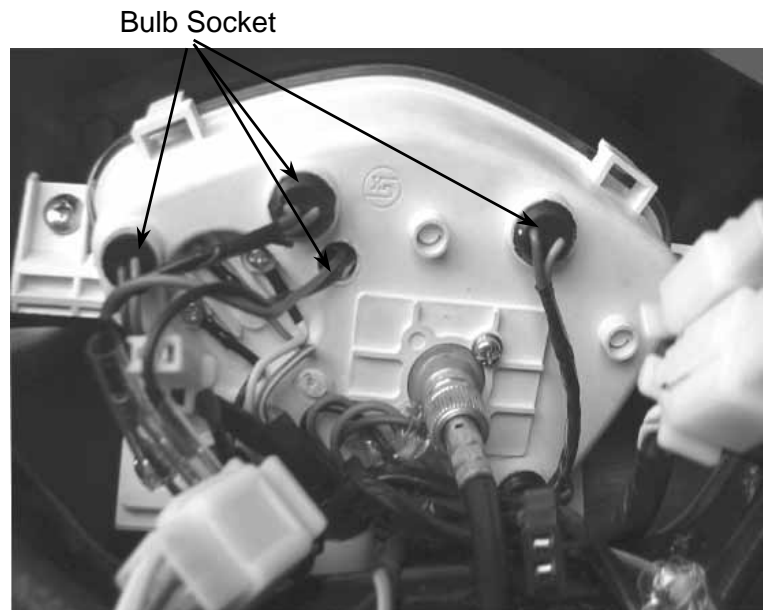

INSTRUMENTS REPLACEMENT

Remove the handlebar rear cover. (⇒2)
 Disconnect the right and left handlebar switches wire couplers.
 Disconnect the speedometer cable.
 Remove the instrument bulb sockets
 Disconnect the two fuel gauge wires.
 Remove the instrument wire clamp screw.
 Remove the three screws attaching the instruments to the handlebar rear cover.
 Remove the instruments.



HEADLIGHT

REMOVAL/BULB REPLACEMENT

Remove the handlebar rear cover. (⇒2)
 Remove the bulb sockets and bulbs.

- *
- The model adopts krypton gas bulb. When installing, do not directly touch the bulb glass with fingers.
 - Use bulbs of the same specifications for replacement.

The installation sequence is the reverse of removal.

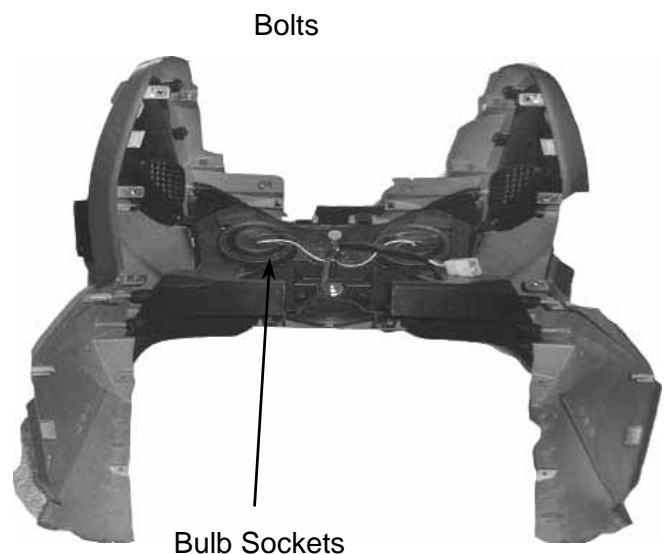

EXHAUST EMISSION CONTROL SYSTEM

SCHEMATIC DRAWING	17-1
EXHAUST EMISSION CONTROL SYSTEM	17-1
TROUBLESHOOTING	17-2
SERVICE INFORMATION.....	17-2
SECONDARY AIR CLEANER.....	17-3
AIR INJECTION CUT-OFF VALVE (A.I.C.V.).....	17-3
REED VALVE	17-4

17. EXHAUST EMISSION CONTROL SYSTEM

SUPER8 50 2T

SCHEMATIC DRAWING

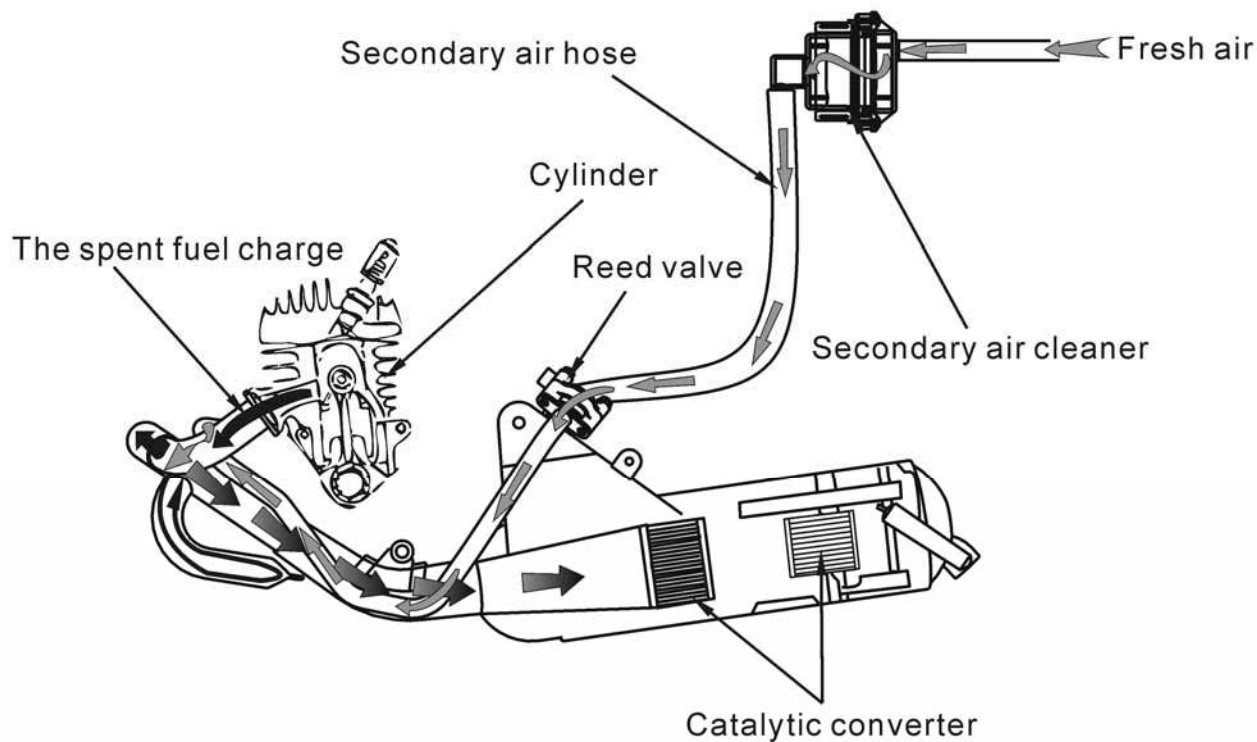

EXHAUST EMISSION CONTROL SYSTEM

The exhaust emission control system adopted in this model utilizes the reed valve to draw secondary air into the exhaust system for re-combustion by means of exhaust pulsation so as to minimize the exhaust emission.

FUNCTION

Item	Purpose	Function
Secondary Air Cleaner	Filter secondary air.	It filters the fresh air drawn for re-burning to prevent dirt or dust from affecting the operation of the air injection cut-off valve.
Air Injection Cut-off Valve	Prevent exhaust muffler noise and backfiring at sudden deceleration.	The air injection cut-off valve usually opens to lead air into the exhaust muffler in which air is re-burned to reduce CO. When the throttle valve closes suddenly, the air injection cut-off valve is actuated by vacuum to close and cut off secondary air in order to prevent exhaust muffler backfiring due to air in the exhaust system.
Reed Valve	Control the secondary air inlet to reduce CO.	When the motorcycle speed is less than 50km per hour, the reed valve operates to draw secondary air into the exhaust system for re-combustion.

17. EXHAUST EMISSION CONTROL SYSTEM

SUPER8 50 2T

TROUBLESHOOTING

High CO at idle speed

1. Damaged or clogged reed valve
2. Damaged or clogged air injection cut-off valve
3. Clogged air cleaner

Backfiring at sudden deceleration

1. Damaged reed valve (malfunction)
2. Faulty air injection cut-off valve (unable to close)
3. Carburetor incorrectly adjusted
4. Faulty air cut-off valve
5. Leaking vacuum tube

Exhaust muffler noise

1. Faulty air injection cut-off valve
2. Broken vacuum tube
3. Faulty reed valve

SERVICE INFORMATION

GENERAL INSTRUCTIONS

- During operation, be careful to avoid scalding caused by the exhaust muffler.
- Note the locations of tubes for proper installation.
- Replace any damaged tube with a new one.
- Make sure to tighten the connector of each tube securely

TOOLS

- Vacuum pump

SPECIFICATIONS

Air injection cut-off valve actuating pressure -

250mm/Hg - 30 liter/min.

Reed valve stopper clearance - 4.6mm

17. EXHAUST EMISSION CONTROL SYSTEM

SUPER8 50 2T

SECONDARY AIR CLEANER / AIR INJECTION CONTROL VALVE (A.I.C.V.)

REMOVAL

Remove the seat. (⇒2-4)
Remove the body cover.
Disconnect the secondary air cleaner / (A.I.C.V) connecting tube.

INSPECTION

Remove two screws on the air cleaner/air injection control valve.
Replace new one when the filter elements obstruct considerable dirt.

INSTALLATION

The installation sequence is the reverse of removal.

*

- The secondary air cleaner must be assembled and installed properly to avoid dust entering the air cleaner.
- When installing, be careful not to bend or twist the tubes and check for proper installation.
- The tube length is very important to its performance, use the tube of same specification for replacement.

Secondary Air Cleaner / A.I.C.V.

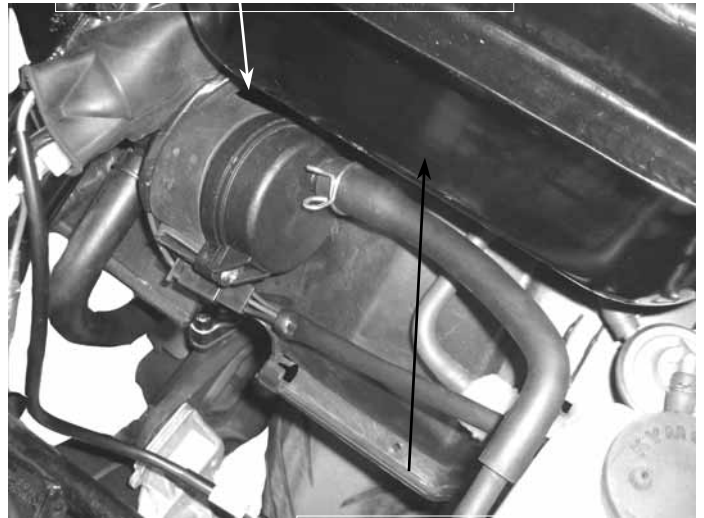

Air Inlet Tube

Air Outlet Tube



Air Inlet Tube



17. EXHAUST EMISSION CONTROL SYSTEM

SUPER8 50 2T

REED VALVE

REMOVAL

Disconnect the secondary air inlet tube connector.
Remove the reed valve cover three bolts.

Reed Valve Cover Bolt

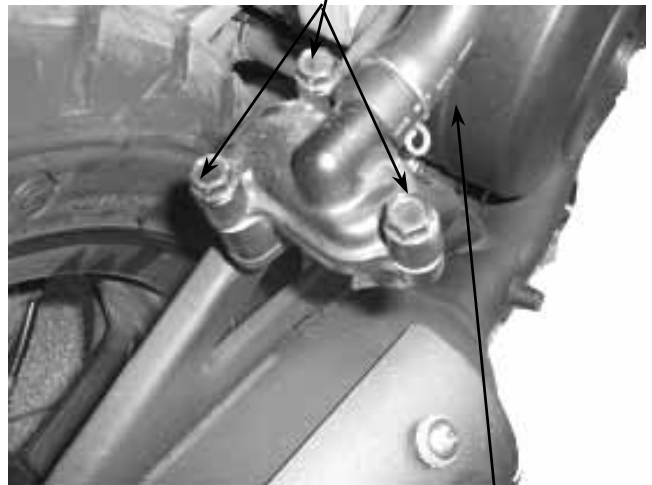

Secondary Air Inlet Tube Clip

Remove the three bolts attaching the reed valve cover and the reed valve.

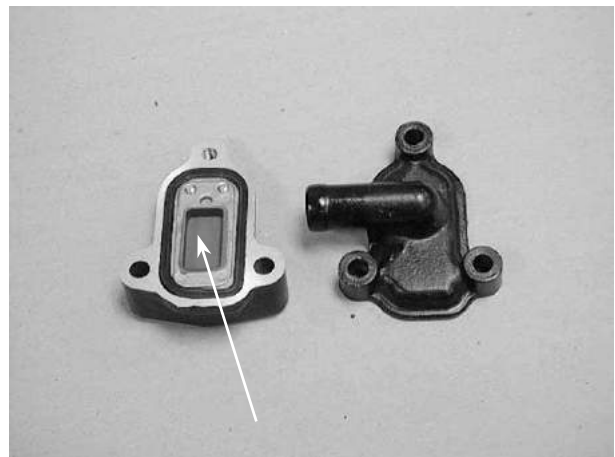

Reed Valve

INSPECTION

Check the reed valve for cracks, damage, big clearance or weak reeds. Replace if necessary.
Check the gasket and O-ring for damage or deterioration and replace if necessary.
Reed valve stopper clearance: 4.6mm

INSTALLATION

Install the reed valve in the reverse order of removal.

*

- When installing, be careful not to bend or twist the tubes and check for proper installation.



Reed Stopper